

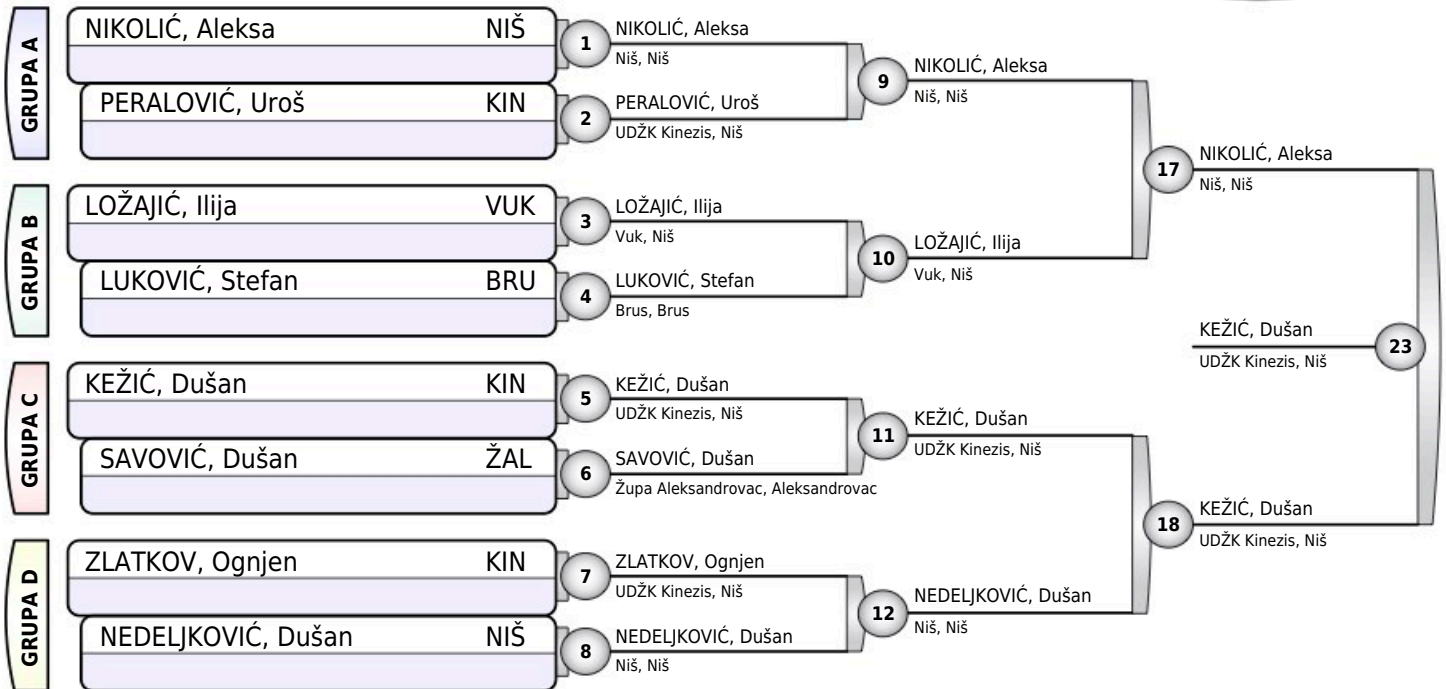

REGIONALNO CS JUNIORI

Niš, 09.04.2022.

JUNIORI
-60KG
8 takmičara



Rezultati

1. KEŽIĆ, Dušan KIN
2. NIKOLIĆ, Aleksa NIŠ
3. PERALOVIĆ, Uroš KIN
3. ZLATKOV, Ognjen KIN
5. NEDELJKOVIĆ, Dušan NIŠ
5. LOŽAJIĆ, Ilija VUK
7. LUKOVIĆ, Stefan BRU
7. SAVOVIĆ, Dušan ŽAL

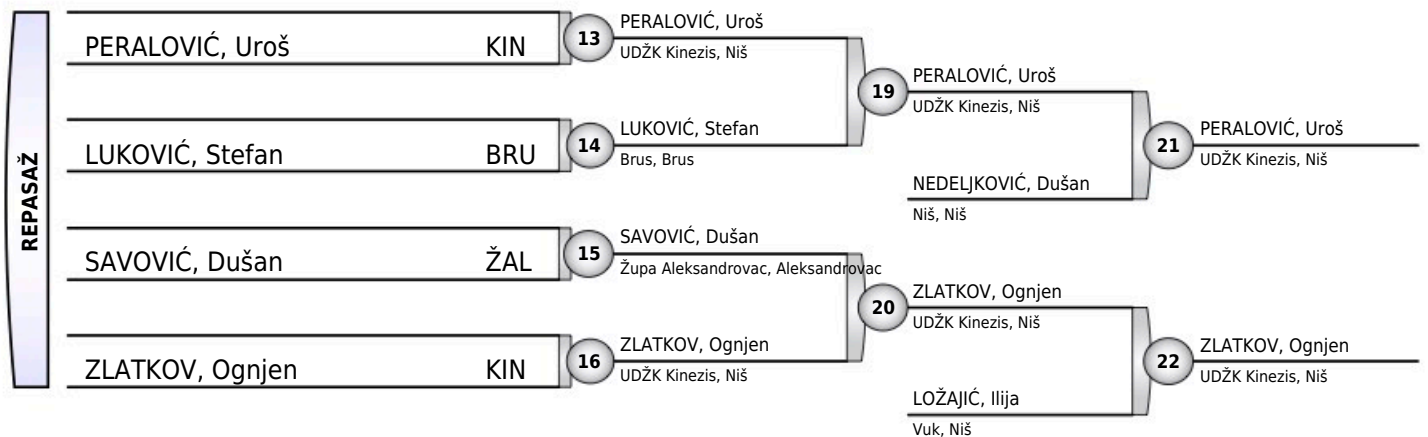



REGIONALNO CS JUNIORI

Niš, 09.04.2022.

JUNIORI
-66KG
7 takmičara

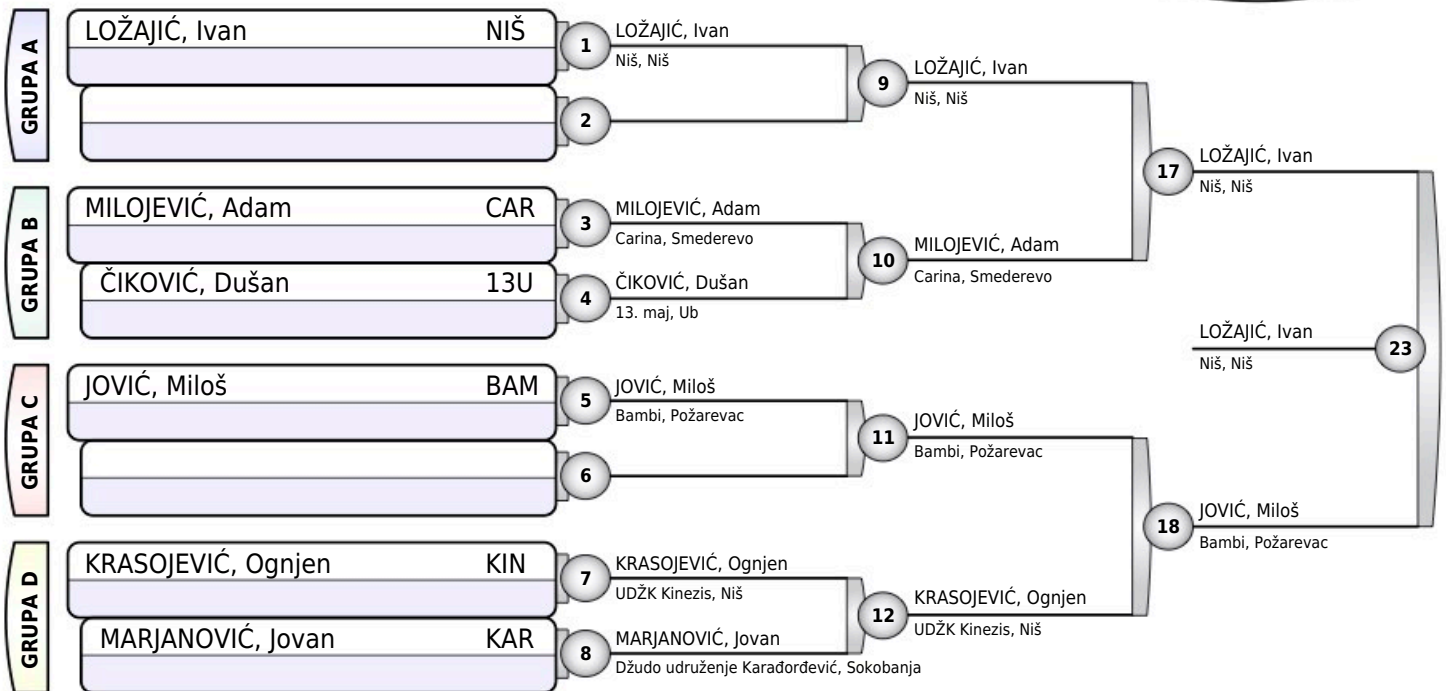

Rezultati

1. LOŽAJIĆ, Ivan NIŠ
2. JOVIĆ, Miloš BAM
3. KRASOJEVIĆ, Ognjen KIN
3. MILOJEVIĆ, Adam CAR
5. ČIKOVIĆ, Dušan 13U
5. MARJANOVIĆ, Jovan KAR
- 7.
- 7.

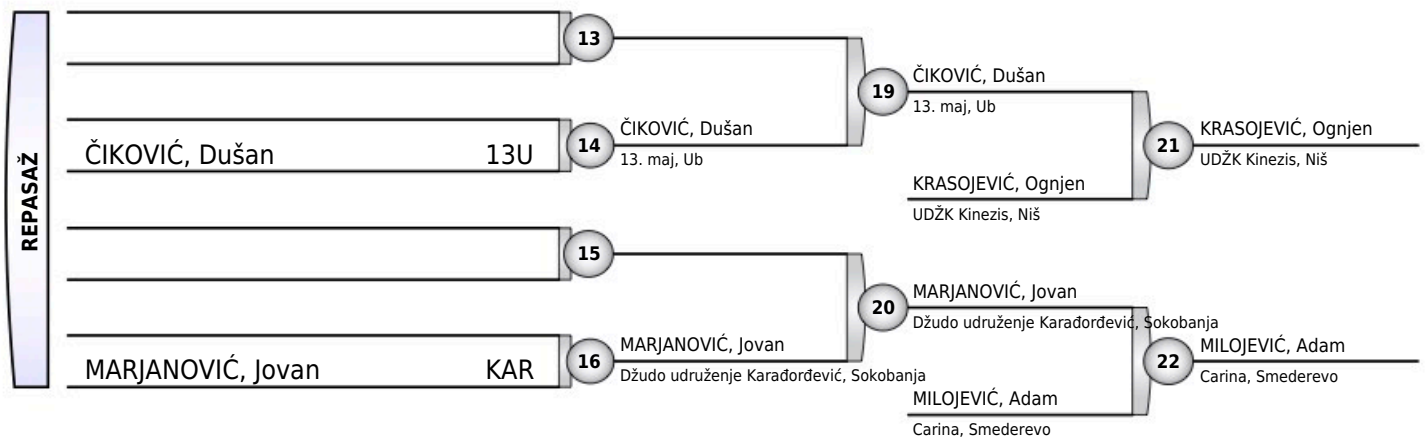



REGIONALNO CS JUNIORI

Niš, 09.04.2022.

JUNIORI
-73KG
9 takmičara

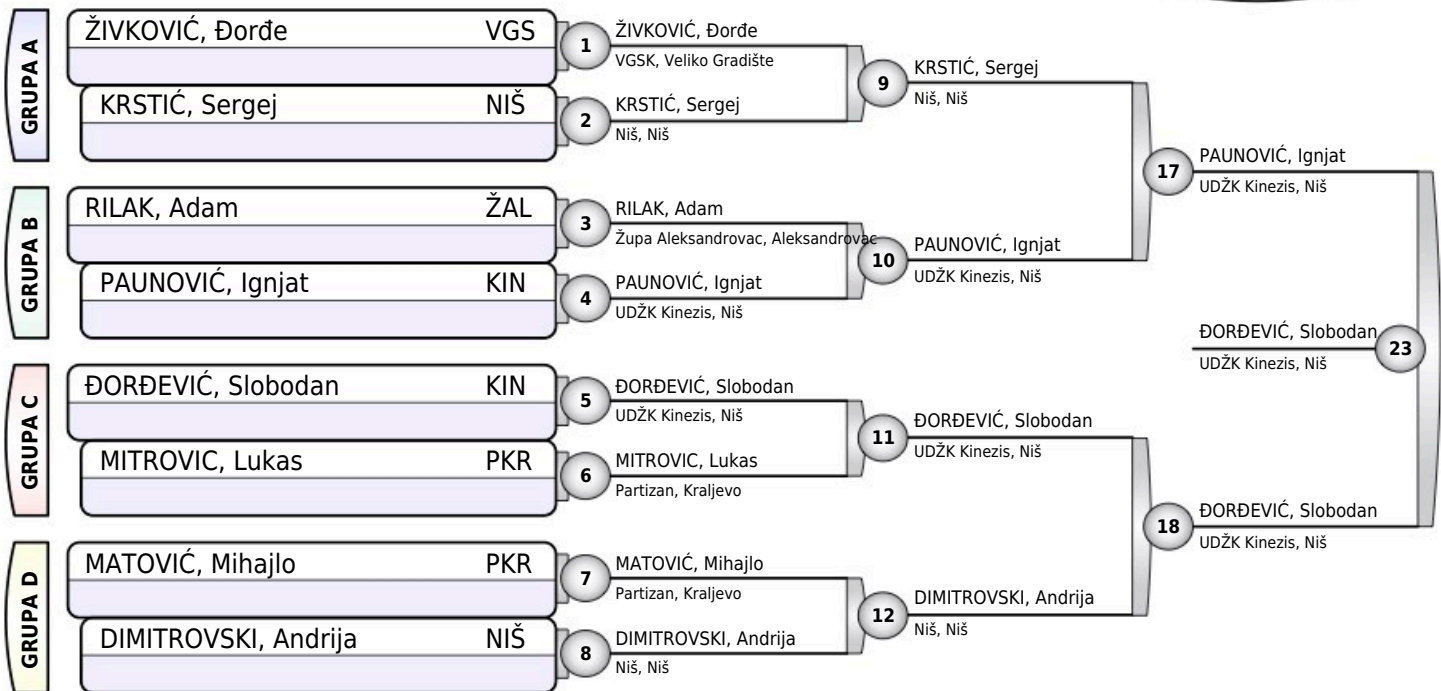

Rezultati

- ĐORĐEVIĆ, Slobodan KIN
- PAUNOVIĆ, Ignjat KIN
- DIMITROVSKI, Andrija NIŠ
- KRSTIĆ, Sergej NIŠ
- ŽIVKOVIĆ, Đorđe VGS
- MITROVIC, Lukas PKR
- RILAK, Adam ŽAL
- MATOVIĆ, Mihajlo PKR

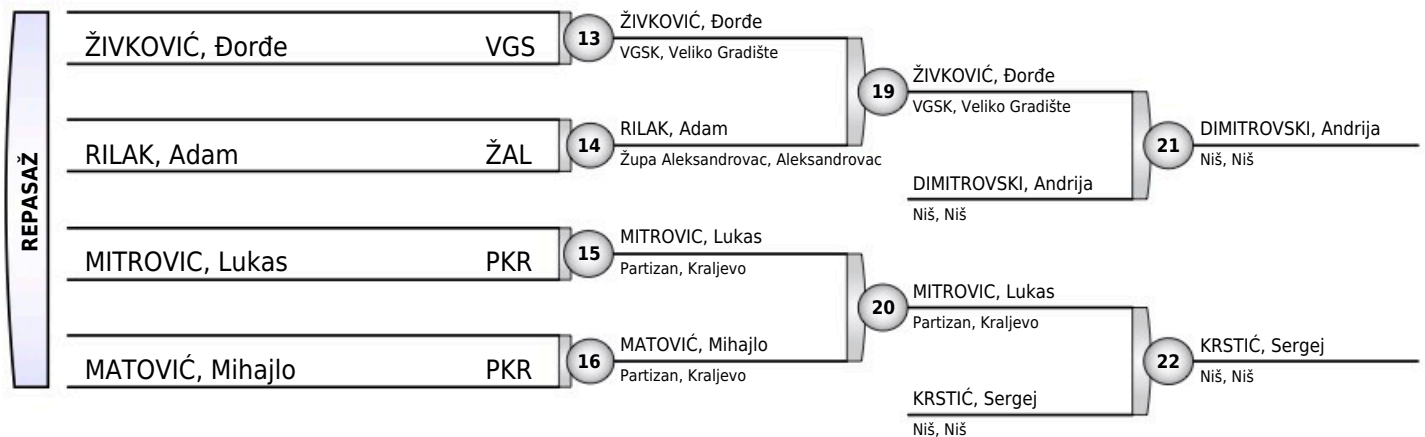



REGIONALNO CS JUNIORI

Niš, 09.04.2022.

JUNIORI
-81KG
7 takmičara

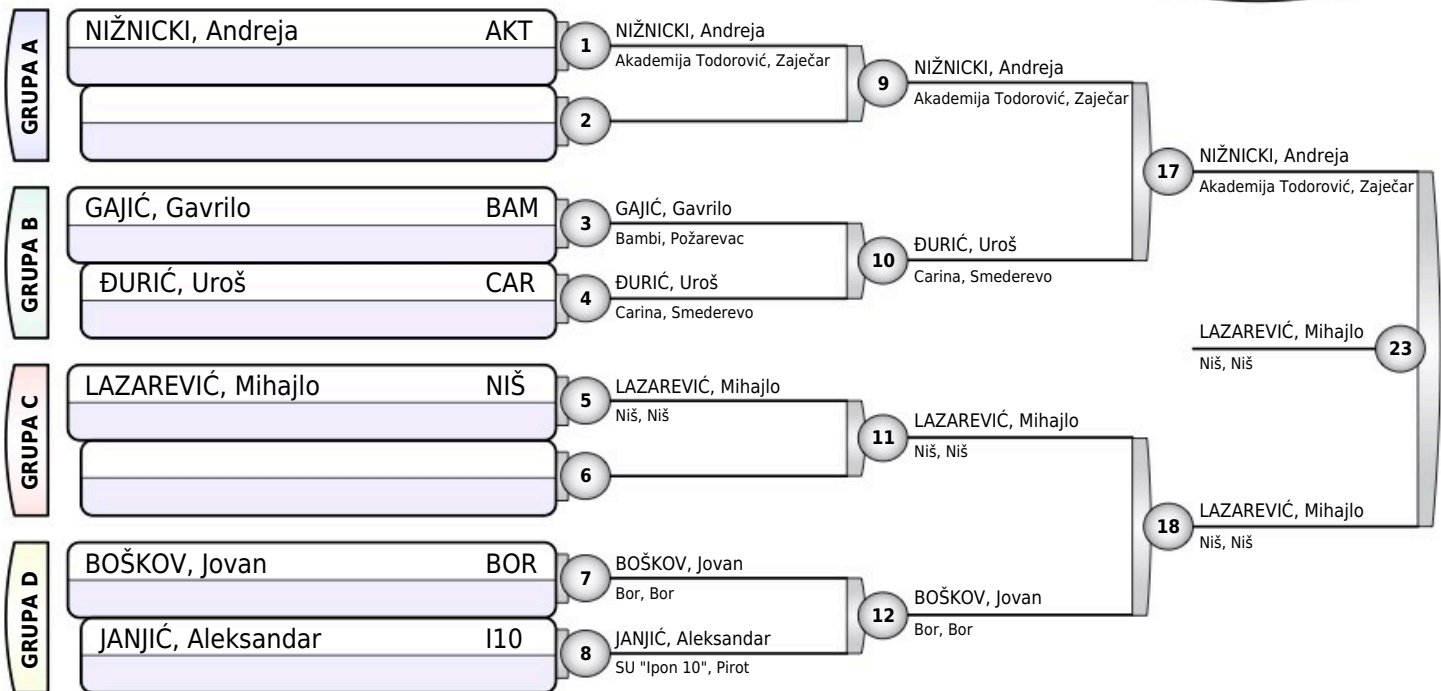

Rezultati

1. LAZAREVIĆ, Mihajlo NIŠ
2. NIŽNICKI, Andreja AKT
3. BOŠKOV, Jovan BOR
3. JANJIĆ, Aleksandar I10
5. GAJIĆ, Gavriilo BAM
5. ĐURIĆ, Uroš CAR
- 7.
- 7.

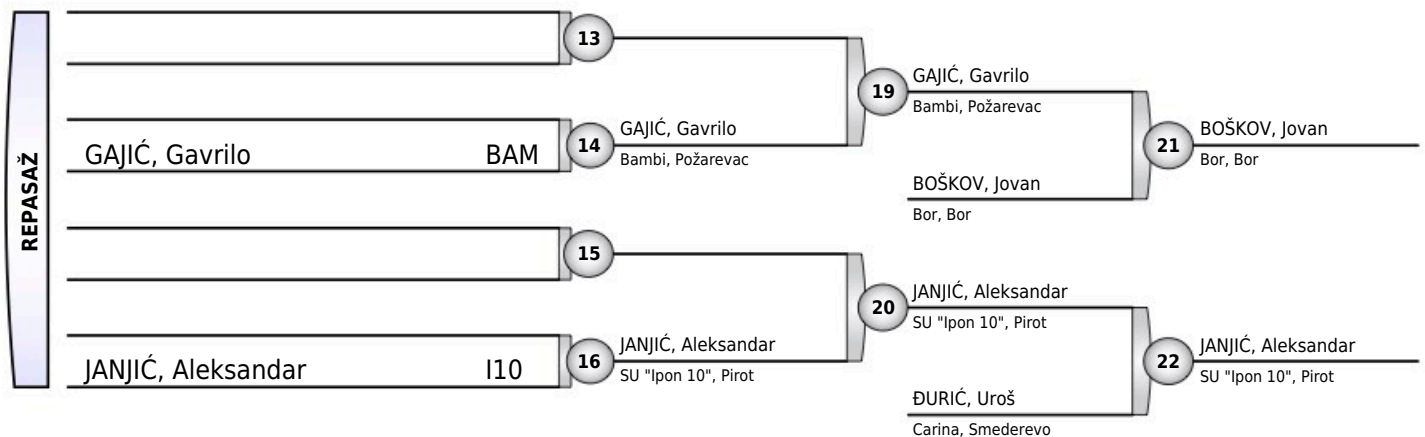



REGIONALNO CS JUNIORI

Niš, 09.04.2022.

JUNIORI
-90KG
9 takmičara

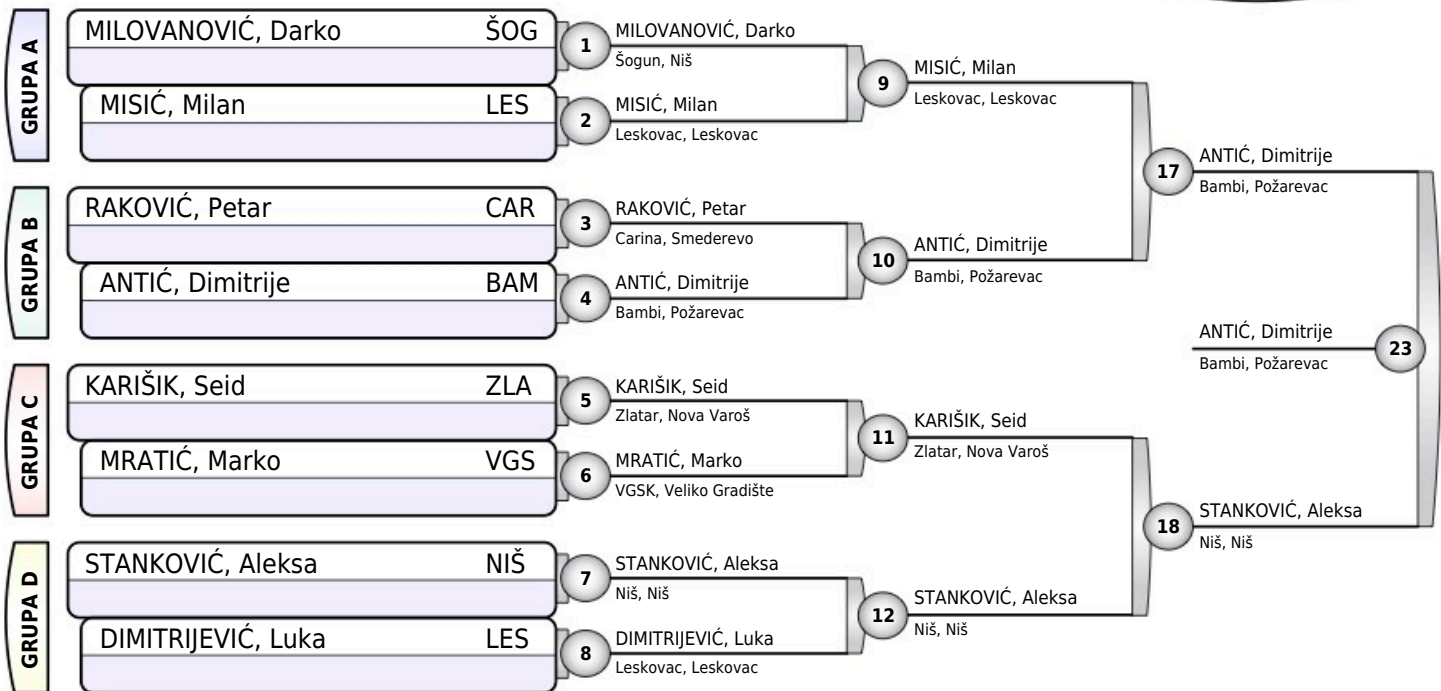

Rezultati

1. ANTIĆ, Dimitrije BAM
2. STANKOVIĆ, Aleksa NIŠ
3. RAKOVIĆ, Petar CAR
3. MISIĆ, Milan LES
5. KARIŠIK, Seid ZLA
5. DIMITRIJEVIĆ, Luka LES
7. MRATIĆ, Marko VGS
7. MILOVANOVIĆ, Darko ŠOG

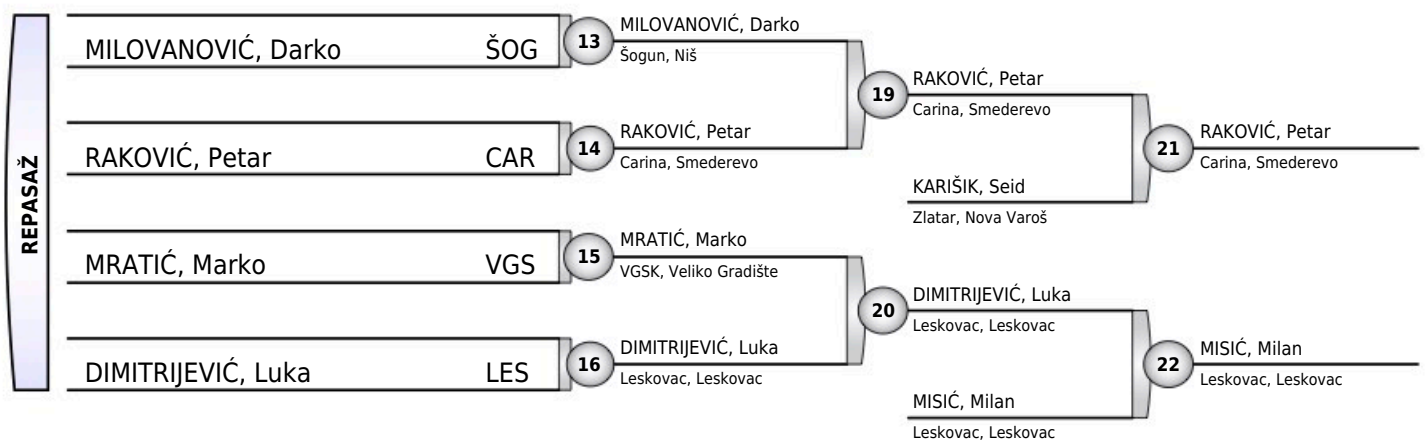



REGIONALNO CS JUNIORI

Niš, 09.04.2022.

JUNIORI
-100KG
4 takmičara

TAKMIČAR I KLUB	1	2	3	4	POBEDA	BODOVA	MESTO
1 KOVAČEVIĆ, Luka Šogun, Niš		0	0	0	0	0	3
2 STOJKOV, Aleksandar UDŽK Kinezis, Niš	10		10	10	3	30	1
3 LAZIĆ, Uroš Niš, Niš	10	0		0	1	10	3
4 ALEKSIĆ, Andrija Bambi, Požarevac	10	0	1		2	11	2

KOVAČEVIĆ, Luka	ŠOG	1	STOJKOV, Aleksandar
STOJKOV, Aleksandar	KIN		UDŽK Kinezis, Niš
LAZIĆ, Uroš	NIŠ	2	ALEKSIĆ, Andrija
ALEKSIĆ, Andrija	BAM		Bambi, Požarevac
KOVAČEVIĆ, Luka	ŠOG	3	LAZIĆ, Uroš
LAZIĆ, Uroš	NIŠ		Niš, Niš
STOJKOV, Aleksandar	KIN	4	STOJKOV, Aleksandar
ALEKSIĆ, Andrija	BAM		UDŽK Kinezis, Niš
KOVAČEVIĆ, Luka	ŠOG	5	ALEKSIĆ, Andrija
ALEKSIĆ, Andrija	BAM		Bambi, Požarevac
STOJKOV, Aleksandar	KIN	6	STOJKOV, Aleksandar
LAZIĆ, Uroš	NIŠ		UDŽK Kinezis, Niš

Rezultati

1. STOJKOV, Aleksandar KIN
2. ALEKSIĆ, Andrija BAM
3. LAZIĆ, Uroš NIŠ
3. KOVAČEVIĆ, Luka ŠOG



REGIONALNO CS JUNIORI

Niš, 09.04.2022.

JUNIORI
+100KG
2 takmičara

STOŠIĆ, Andrija	KIN	1	STOŠIĆ, Andrija UDŽK Kinezis, Niš
ANTIĆ, Obren	BOR		
STOŠIĆ, Andrija	KIN	2	STOŠIĆ, Andrija UDŽK Kinezis, Niš
ANTIĆ, Obren	BOR		
		3	

Rezultati

1. STOŠIĆ, Andrija KIN
2. ANTIĆ, Obren BOR



REGIONALNO CS JUNIORI

Niš, 09.04.2022.

JUNIORKE
-48KG
7 takmičarki

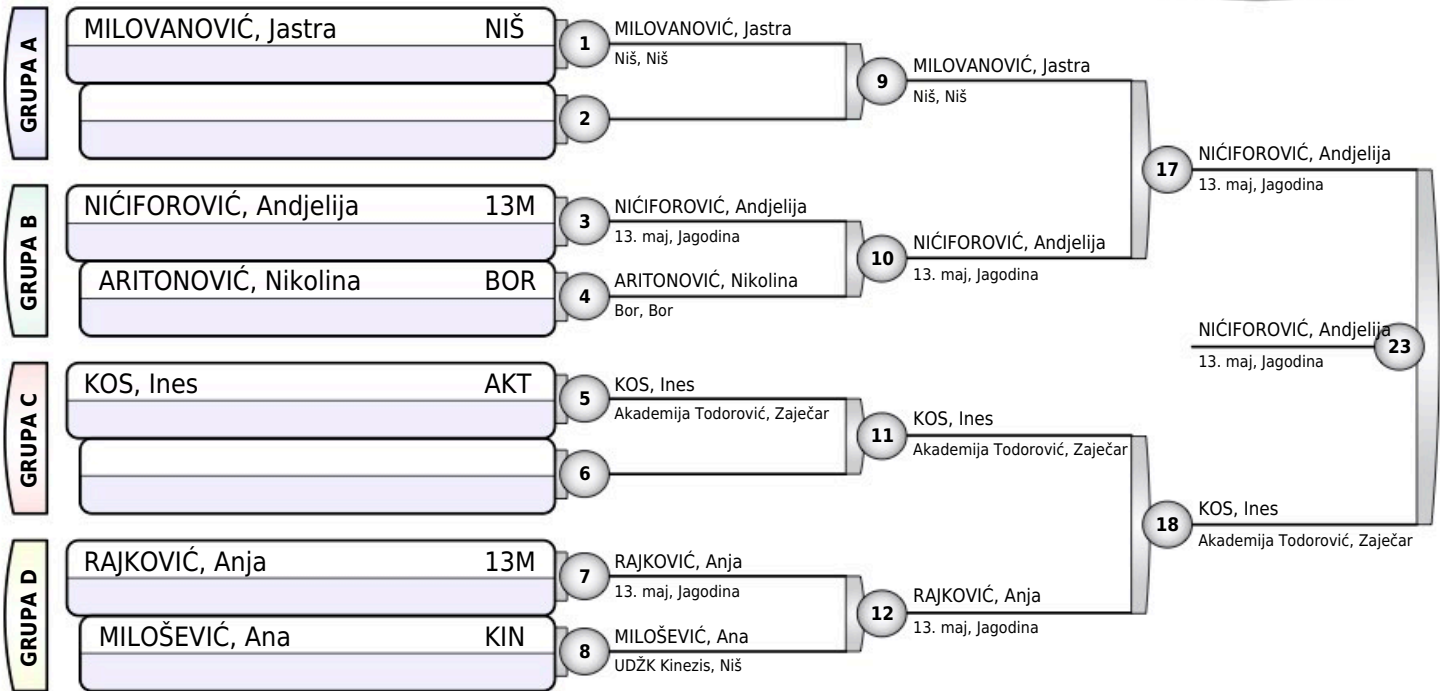

Rezultati

1. NIĆIFOROVIĆ, Andjelija 13M
2. KOS, Ines AKT
3. RAJKOVIĆ, Anja 13M
3. MILOVANOVIĆ, Jastr NIŠ
5. ARITONOVIĆ, Nikolina BOR
5. MILOŠEVIĆ, Ana KIN
- 7.
- 7.

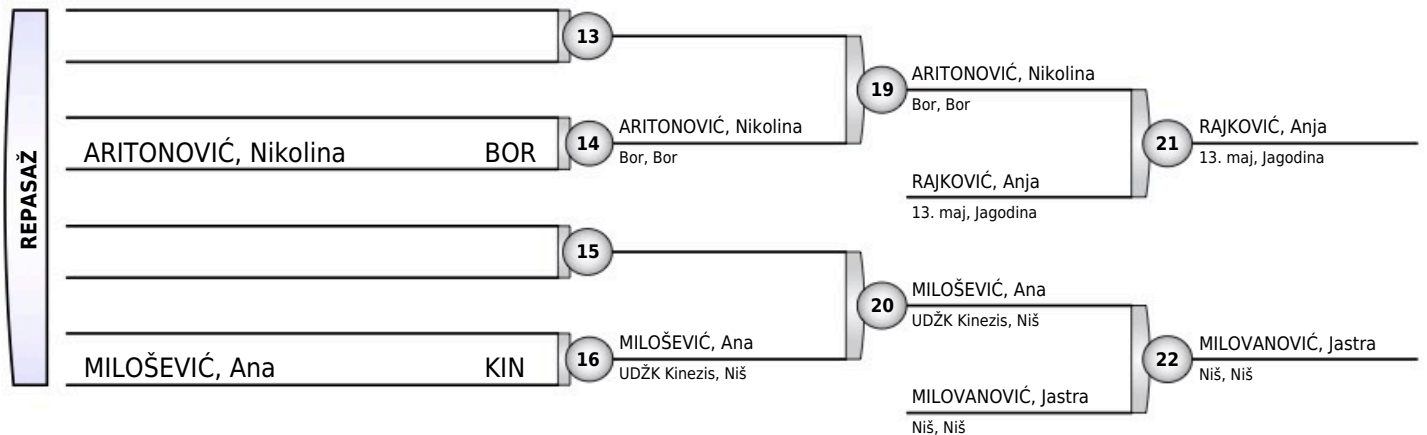



REGIONALNO CS JUNIORI

Niš, 09.04.2022.

JUNIORKE
-52KG
2 takmičarke

RADULOVIĆ, Anita	GOČ	1	JEVTIĆ, Danijela 13. maj, Ub
JEVTIĆ, Danijela	13U		
RADULOVIĆ, Anita	GOČ	2	JEVTIĆ, Danijela 13. maj, Ub
JEVTIĆ, Danijela	13U		
		3	

Rezultati

- | | |
|---------------------|-----|
| 1. JEVTIĆ, Danijela | 13U |
| 2. RADULOVIĆ, Anita | GOČ |



REGIONALNO CS JUNIORI

Niš, 09.04.2022.

JUNIORKE
-57KG
2 takmičarke

PLJEVALJČIĆ, Tijana	GOČ	1	ČIKARIĆ, Nevena Brus, Brus
ČIKARIĆ, Nevena	BRU		
PLJEVALJČIĆ, Tijana	GOČ	2	ČIKARIĆ, Nevena Brus, Brus
ČIKARIĆ, Nevena	BRU		
		3	

Rezultati

1. ČIKARIĆ, Nevena BRU
2. PLJEVALJČIĆ, Tijana GOČ



REGIONALNO CS JUNIORI

Niš, 09.04.2022.

JUNIORKE
-63KG
4 takmičarki

TAKMIČAR I KLUB	1	2	3	4	POBEDA	BODOVA	MESTO
1 IVANOVIĆ, Anđela Šogun, Niš		10	10	10	3	30	1
2 JELIĆ, Milica 13. maj, Ub	0		10	10	2	20	2
3 ĐOKIĆ, Marija VGSK, Veliko Gradište	0	0		10	1	10	3
4 JOVIČIĆ, Sofija SU "Ipon 10", Pirot	0	0	0		0	0	3

IVANOVIĆ, Anđela	ŠOG	1	IVANOVIĆ, Anđela
JELIĆ, Milica	13U		Šogun, Niš
ĐOKIĆ, Marija	VGS	2	ĐOKIĆ, Marija
JOVIČIĆ, Sofija	I10		VGSK, Veliko Gradište
IVANOVIĆ, Anđela	ŠOG	3	IVANOVIĆ, Anđela
ĐOKIĆ, Marija	VGS		Šogun, Niš
JELIĆ, Milica	13U	4	JELIĆ, Milica
JOVIČIĆ, Sofija	I10		13. maj, Ub
IVANOVIĆ, Anđela	ŠOG	5	IVANOVIĆ, Anđela
JOVIČIĆ, Sofija	I10		Šogun, Niš
JELIĆ, Milica	13U	6	JELIĆ, Milica
ĐOKIĆ, Marija	VGS		13. maj, Ub

Rezultati

1. IVANOVIĆ, Anđela ŠOG
2. JELIĆ, Milica 13U
3. ĐOKIĆ, Marija VGS
3. JOVIČIĆ, Sofija I10



REGIONALNO CS JUNIORI

Niš, 09.04.2022.

JUNIORKE
-70KG
5 takmičarki

TAKMIČAR I KLUB	1	2	3	4	5	POBEDA	BODOVA	MESTO
1 KOCIĆ, Zorana Leskovac, Leskovac		0	0	0	0	0	0	5
2 ŽIVKOVIĆ, Sofija 13. maj, Jagodina	10		10	10	10	4	40	1
3 SAVIĆ, Stefana Partizan, Kraljevo	10	0		0	10	2	20	3
4 JOVANOVIĆ, Milica Bor, Bor	10	0	10		10	3	30	2
5 CVETKOVIĆ, Ana Šogun, Niš	10	0	0	0		1	10	3

KOCIĆ, Zorana	LES	1	ŽIVKOVIĆ, Sofija
ŽIVKOVIĆ, Sofija	13M		13. maj, Jagodina
SAVIĆ, Stefana	PKR	2	JOVANOVIĆ, Milica
JOVANOVIĆ, Milica	BOR		Bor, Bor
KOCIĆ, Zorana	LES	3	CVETKOVIĆ, Ana
CVETKOVIĆ, Ana	ŠOG		Šogun, Niš
ŽIVKOVIĆ, Sofija	13M	4	ŽIVKOVIĆ, Sofija
SAVIĆ, Stefana	PKR		13. maj, Jagodina
JOVANOVIĆ, Milica	BOR	5	JOVANOVIĆ, Milica
CVETKOVIĆ, Ana	ŠOG		Bor, Bor
KOCIĆ, Zorana	LES	6	SAVIĆ, Stefana
SAVIĆ, Stefana	PKR		Partizan, Kraljevo
ŽIVKOVIĆ, Sofija	13M	7	ŽIVKOVIĆ, Sofija
JOVANOVIĆ, Milica	BOR		13. maj, Jagodina
SAVIĆ, Stefana	PKR	8	SAVIĆ, Stefana
CVETKOVIĆ, Ana	ŠOG		Partizan, Kraljevo
KOCIĆ, Zorana	LES	9	JOVANOVIĆ, Milica
JOVANOVIĆ, Milica	BOR		Bor, Bor
ŽIVKOVIĆ, Sofija	13M	10	ŽIVKOVIĆ, Sofija
CVETKOVIĆ, Ana	ŠOG		13. maj, Jagodina

Rezultati

- | | |
|----------------------|-----|
| 1. ŽIVKOVIĆ, Sofija | 13M |
| 2. JOVANOVIĆ, Milica | BOR |
| 3. SAVIĆ, Stefana | PKR |
| 3. CVETKOVIĆ, Ana | ŠOG |
| 5. KOCIĆ, Zorana | LES |



REGIONALNO CS JUNIORI

Niš, 09.04.2022.

JUNIORKE
-78KG
2 takmičarke

LEŠEVIĆ, Anđela	PKR	1	ARITONOVIĆ, Teodora
ARITONOVIĆ, Teodora	BOR		Bor, Bor
LEŠEVIĆ, Anđela	PKR	2	ARITONOVIĆ, Teodora
ARITONOVIĆ, Teodora	BOR		Bor, Bor
		3	

Rezultati

1. ARITONOVIĆ, Teodora BOR
2. LEŠEVIĆ, Anđela PKR



REGIONALNO CS JUNIORI

Niš, 09.04.2022.

JUNIORKE
+78KG
4 takmičarki

TAKMIČAR I KLUB	1	2	3	4	POBEDA	BODOVA	MESTO
1 ĐORĐEVIĆ, Teodora Goč, Vrnjačka Banja	///	10	0	10	2	20	2
2 PETKOVIĆ, Andrijana Župa Aleksandrovac, Aleksandrovac	0	///	0	0	0	0	3
3 PAVLOVIĆ, Emilija Leskovac, Leskovac	10	10	///	10	3	30	1
4 ŠAINOVIC, Sara Bor, Bor	0	10	0	///	1	10	3

ĐORĐEVIĆ, Teodora	GOČ	1	ĐORĐEVIĆ, Teodora
PETKOVIĆ, Andrijana	ŽAL		Goč, Vrnjačka Banja
PAVLOVIĆ, Emilija	LES	2	PAVLOVIĆ, Emilija
ŠAINOVIC, Sara	BOR		Leskovac, Leskovac
ĐORĐEVIĆ, Teodora	GOČ	3	PAVLOVIĆ, Emilija
PAVLOVIĆ, Emilija	LES		Leskovac, Leskovac
PETKOVIĆ, Andrijana	ŽAL	4	ŠAINOVIC, Sara
ŠAINOVIC, Sara	BOR		Bor, Bor
ĐORĐEVIĆ, Teodora	GOČ	5	ĐORĐEVIĆ, Teodora
ŠAINOVIC, Sara	BOR		Goč, Vrnjačka Banja
PETKOVIĆ, Andrijana	ŽAL	6	PAVLOVIĆ, Emilija
PAVLOVIĆ, Emilija	LES		Leskovac, Leskovac

Rezultati

1. PAVLOVIĆ, Emilija LES
2. ĐORĐEVIĆ, Teodora GOČ
3. ŠAINOVIC, Sara BOR
3. PETKOVIĆ, Andrijana ŽAL