



SREĆNO 2023

Bor, 01.10.2023.

STARIJI POLETARCI

-25KG

3 takmičara

TAKMIČAR I KLUB	1	2	3	POBEDA	BODOVA	MESTO
1 ŽIVANOVIĆ, Petar Džudo udruženje Karađorđević, Sokobanja		0	10	1	10	2
2 BUZUT, Cristian SSSJ OLEG CRETUL, Chisinau	10		1	2	11	1
3 RADOJA, Drago Džudo udruženje Karađorđević, Sokobanja	0	0		0	0	3

ŽIVANOVIĆ, Petar	KAR	1	BUZUT, Cristian
BUZUT, Cristian	SOC		SSSJ OLEG CRETUL, Chisinau
ŽIVANOVIĆ, Petar	KAR	2	ŽIVANOVIĆ, Petar
RADOJA, Drago	KAR		Džudo udruženje Karađorđević, Sokobanja
BUZUT, Cristian	SOC	3	BUZUT, Cristian
RADOJA, Drago	KAR		SSSJ OLEG CRETUL, Chisinau

Rezultati

1. BUZUT, Cristian SOC
2. ŽIVANOVIĆ, Petar KAR
3. RADOJA, Drago KAR



SREĆNO 2023

Bor, 01.10.2023.

STARIJI POLETARCI

-28KG

9 takmičara

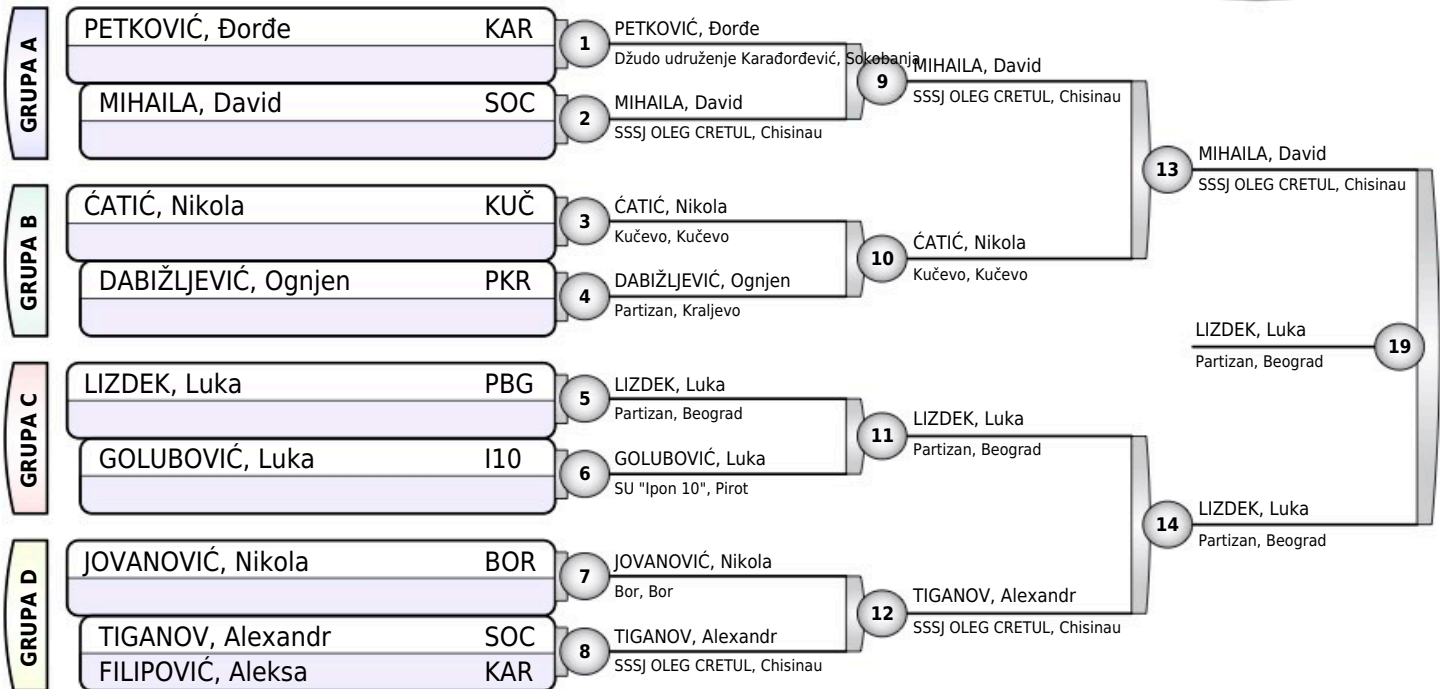

Rezultati

1. LIZDEK, Luka (PBG)
2. MIHAILA, David (SOC)
3. PETKOVIĆ, Đorđe (KAR)
3. GOLUBOVIĆ, Luka (I10)
5. ĆATIĆ, Nikola (KUČ)
5. TIGANOV, Alexandr (SOC)
- 7.
- 7.





SREĆNO 2023

Bor, 01.10.2023.

STARIJI POLETARCI

-31KG

8 takmičara

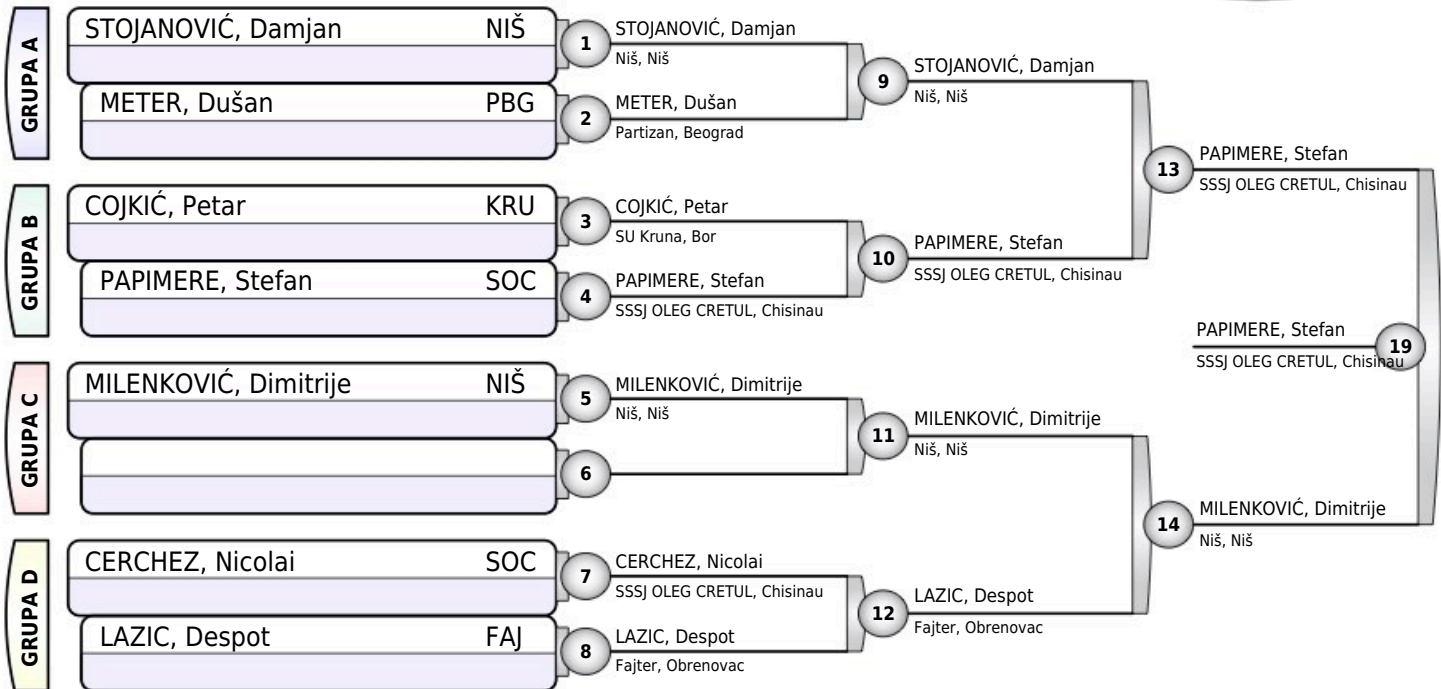

Rezultati

1. PAPIMERE, Stefan SOC
2. MILENKOVIĆ, Dimitrije NIŠ
3. LAZIC, Despot FAJ
3. STOJANOVIĆ, Damjan NIŠ
5. COJKIĆ, Petar KRU
- 5.
- 7.
- 7.

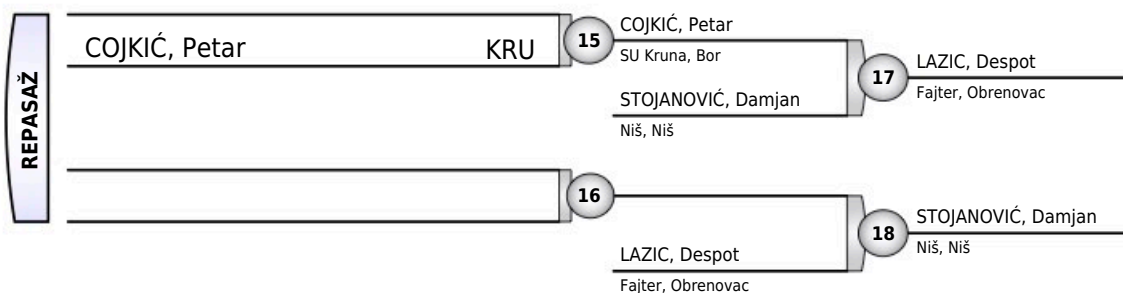



SREĆNO 2023

Bor, 01.10.2023.

STARIJI POLETARCI

-34KG

7 takmičara

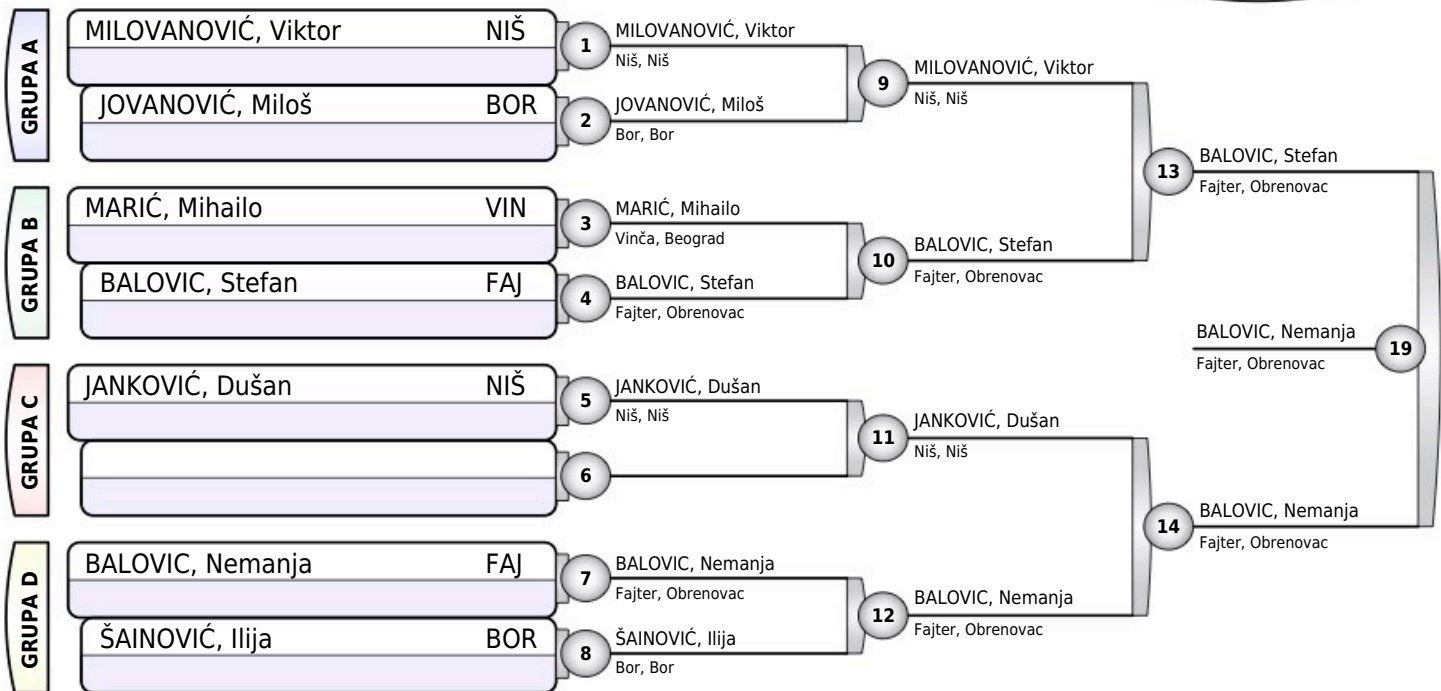

Rezultati

1. BALOVIC, Nemanja FAJ
2. BALOVIC, Stefan FAJ
3. MILOVANOVIĆ, Viktor NIŠ
3. JANKOVIĆ, Dušan NIŠ
5. MARIĆ, Mihailo VIN
5. ŠAINOVIĆ, Ilija BOR
- 7.
- 7.

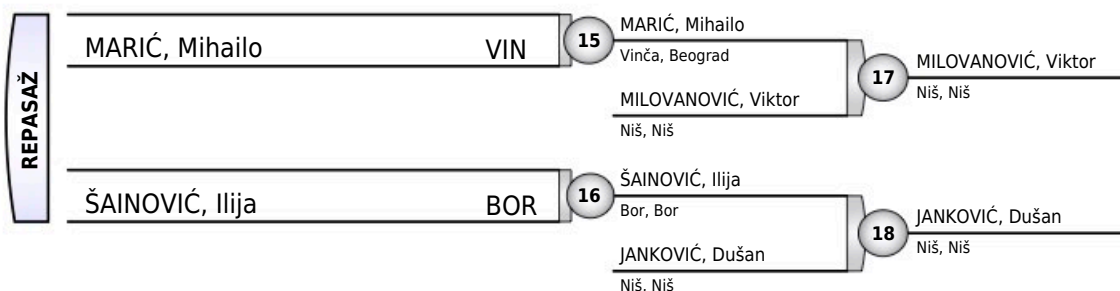



SREĆNO 2023

Bor, 01.10.2023.

STARIJI POLETARCI

-38KG

9 takmičara

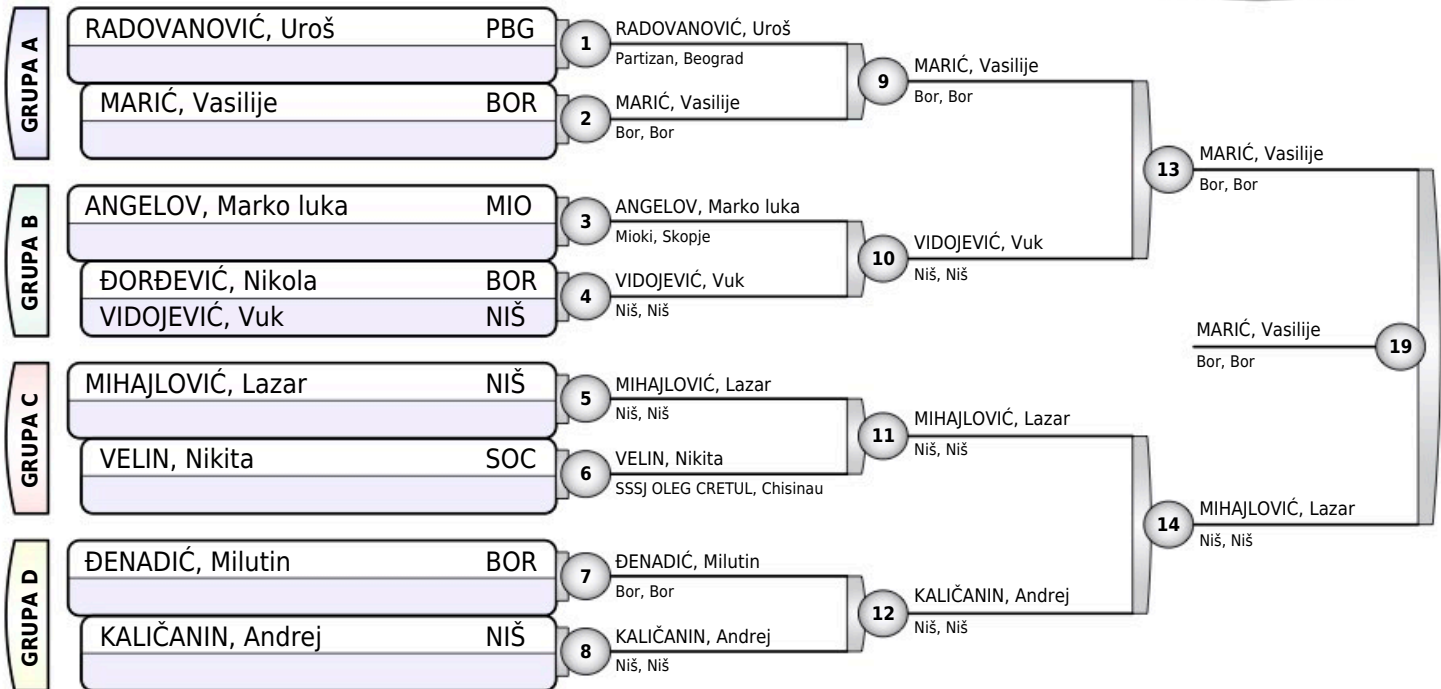

Rezultati

- MARIĆ, Vasilije BOR
- MIHAJLOVIĆ, Lazar NIŠ
- RADOVANOVIĆ, Uroš PBG
- KALIČANIN, Andrej NIŠ
- VIDOJEVIĆ, Vuk NIŠ
- VELIN, Nikita SOC
-
-

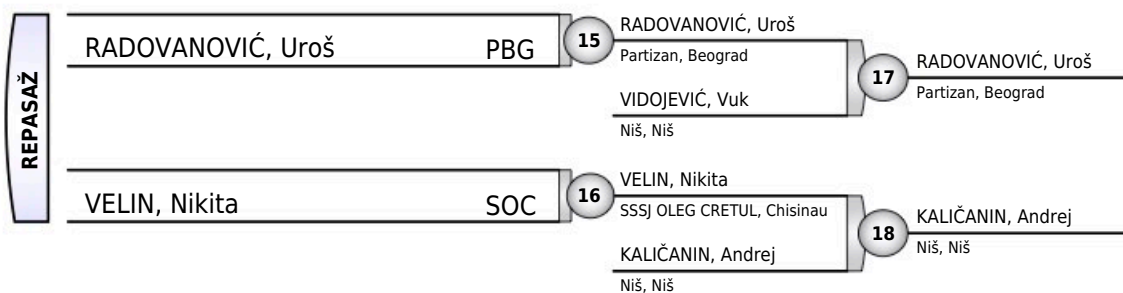



SREĆNO 2023

Bor, 01.10.2023.

STARIJI POLETARCI

-42KG

4 takmičara

TAKMIČAR I KLUB	1	2	3	4	POBEDA	BODOVA	MESTO
1 MIJUŠKOVIĆ, Kosta 13. maj, Jagodina	///	10	0	0	1	10	3
2 STANKOVIĆ, Veljko OJK Bor, Bor	0	///	0	0	0	0	3
3 PANIĆ, Miloš SU "Ipon 10", Pirot	1	1	///	1	3	3	1
4 SPIROVSKI, David Drim, Struga	10	10	0	///	2	20	2

MIJUŠKOVIĆ, Kosta	13M	1	MIJUŠKOVIĆ, Kosta
STANKOVIĆ, Veljko	OBO		13. maj, Jagodina
PANIĆ, Miloš	I10	2	PANIĆ, Miloš
SPIROVSKI, David	DRM		SU "Ipon 10", Pirot
MIJUŠKOVIĆ, Kosta	13M	3	PANIĆ, Miloš
PANIĆ, Miloš	I10		SU "Ipon 10", Pirot
STANKOVIĆ, Veljko	OBO	4	SPIROVSKI, David
SPIROVSKI, David	DRM		Drim, Struga
MIJUŠKOVIĆ, Kosta	13M	5	SPIROVSKI, David
SPIROVSKI, David	DRM		Drim, Struga
STANKOVIĆ, Veljko	OBO	6	PANIĆ, Miloš
PANIĆ, Miloš	I10		SU "Ipon 10", Pirot

Rezultati

1. PANIĆ, Miloš I10
2. SPIROVSKI, David DRM
3. MIJUŠKOVIĆ, Kosta 13M
3. STANKOVIĆ, Veljko OBO



SREĆNO 2023

Bor, 01.10.2023.

STARIJI POLETARCI

-46KG

7 takmičara

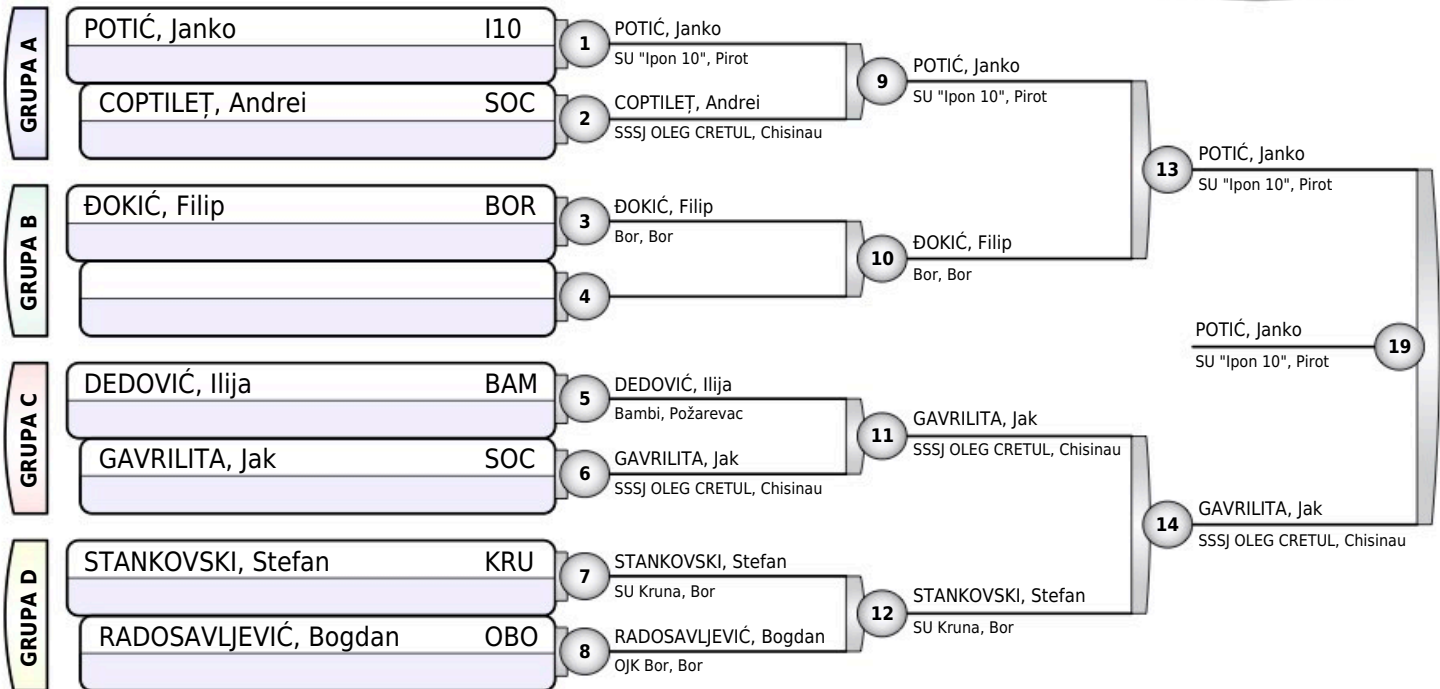

Rezultati

1. POTIĆ, Janko I10
2. GAVRILITA, Jak SOC
3. ĐOKIĆ, Filip BOR
3. STANKOVSKI, Stefan KRU
5. COPTILEȚ, Andrei SOC
5. DEDOVIĆ, Ilija BAM
- 7.
- 7.

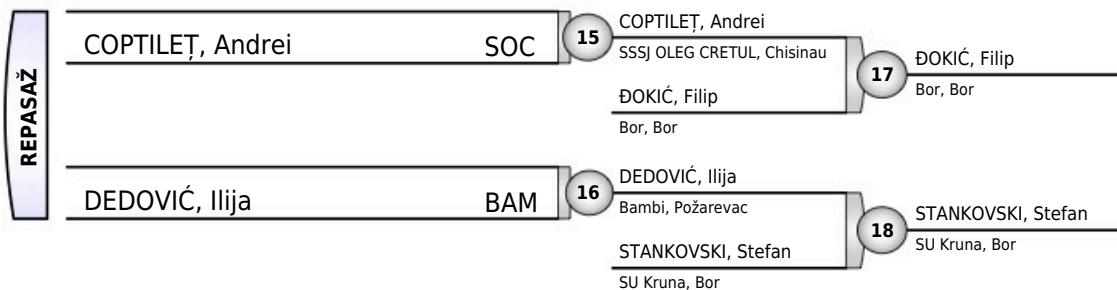



SREĆNO 2023

Bor, 01.10.2023.

STARIJI POLETARCI

-50KG

7 takmičara

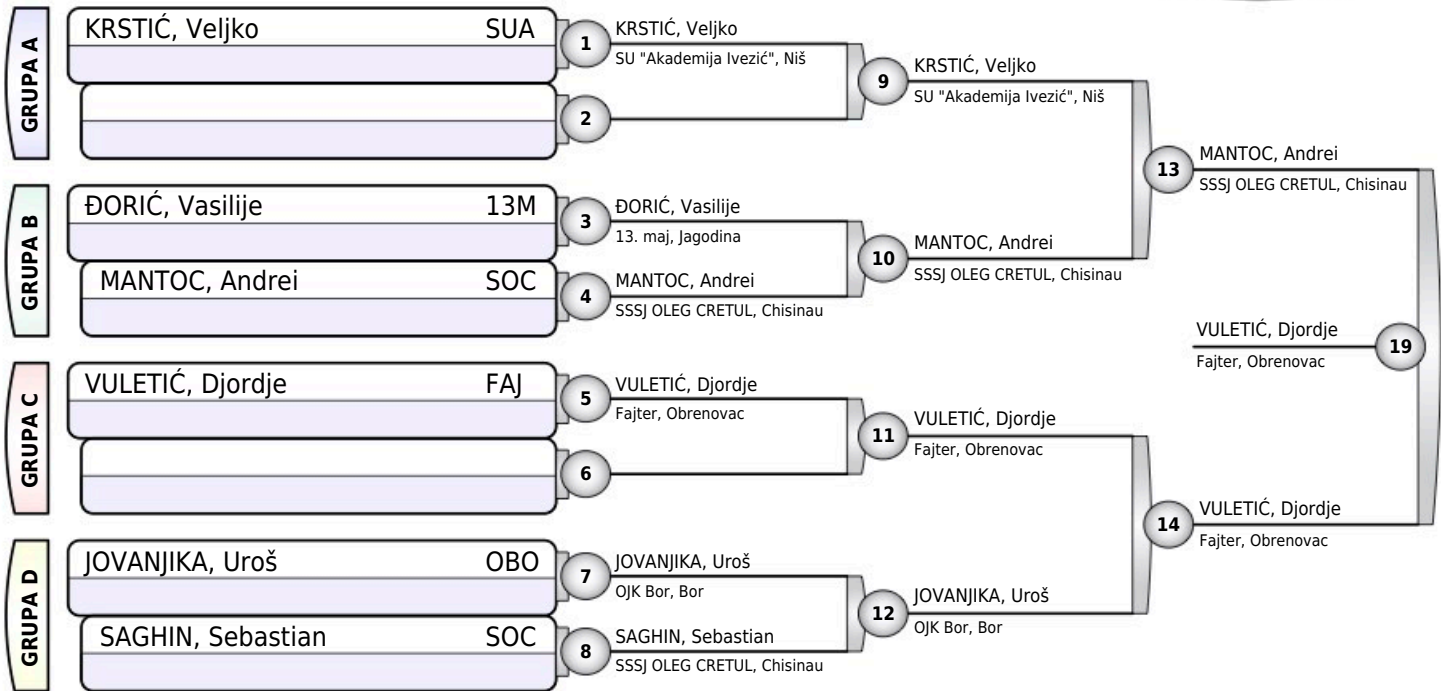

Rezultati

1. VULETIĆ, Djordje FAJ
2. MANTOC, Andrei SOC
3. KRSTIĆ, Veljko SUA
3. JOVANJIKA, Uroš OBO
5. ĐORIĆ, Vasilije 13M
- 7.
- 7.

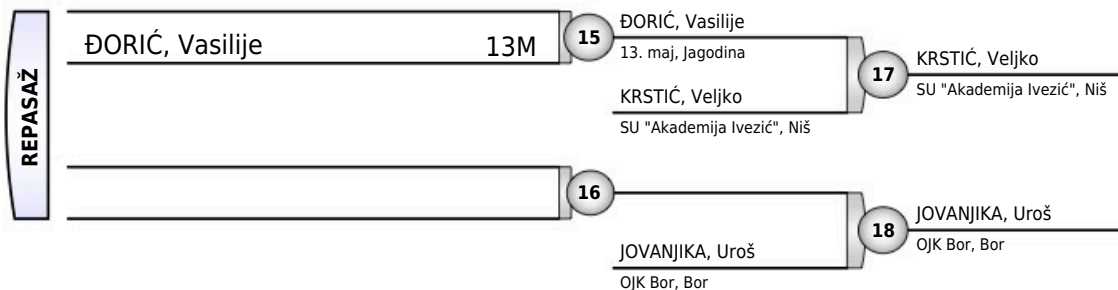



SREĆNO 2023

Bor, 01.10.2023.

STARIJI POLETARCI

+50KG

8 takmičara

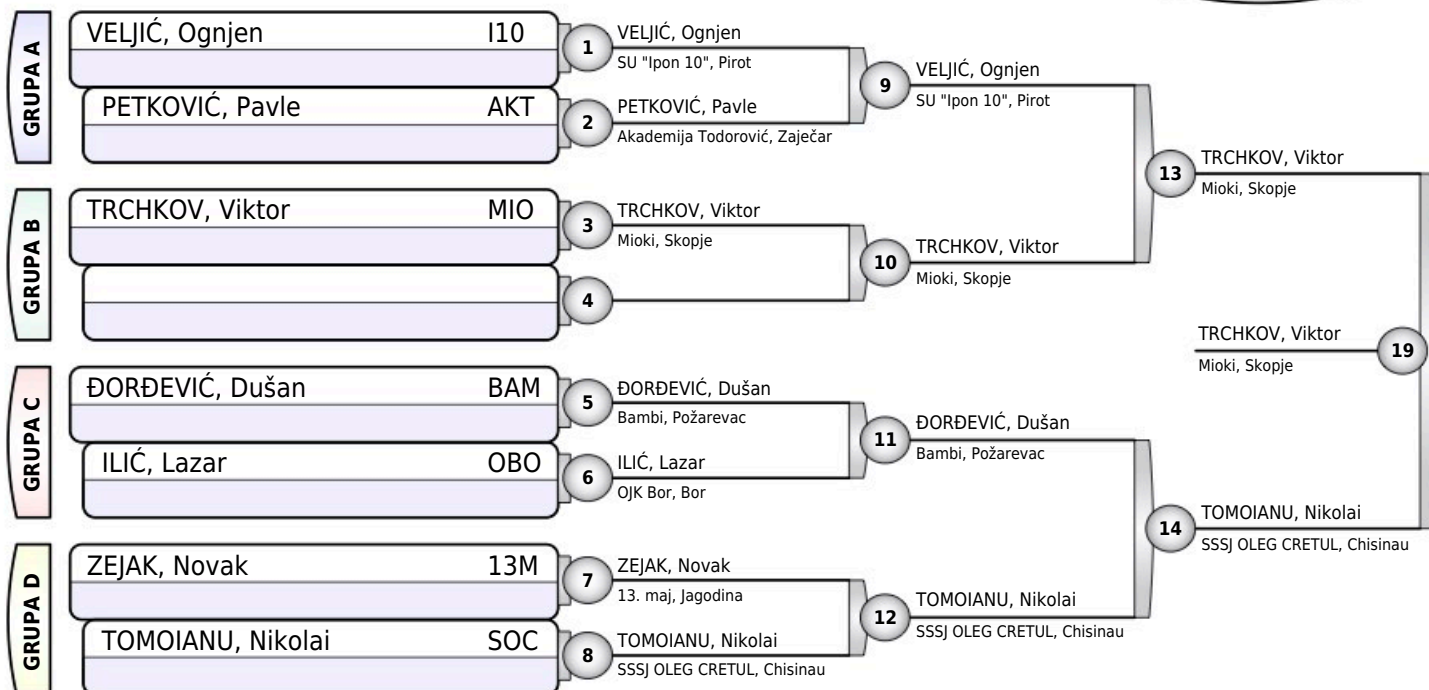

Rezultati

1. TRCHKOV, Viktor MIO
2. TOMOIANU, Nikolai SOC
3. ĐORĐEVIĆ, Dušan BAM
3. VELJIĆ, Ognjen I10
5. ZEJAK, Novak 13M
- 5.
- 7.
- 7.

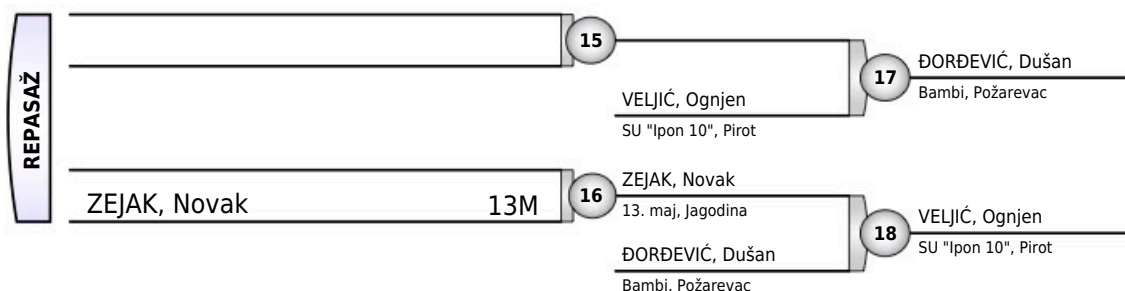



SREĆNO 2023

Bor, 01.10.2023.

STARIJE POLETARKE

-22KG

1 takmičarka

STANOJEVIĆ, Julijana

KAR

1

STANOJEVIĆ, Julijana

Džudo udruženje Karađorđević, Sokobanja

Rezultati

1. STANOJEVIĆ, Julijana

KAR



SREĆNO 2023

Bor, 01.10.2023.

STARIJE POLETARKE

-25KG

2 takmičarke

USAINOVIĆ, Helena	KAR	1	USAINOVIĆ, Helena Džudo udruženje Karađorđević, Sokobanja
STANKOVIĆ, Aleksija	I10		
USAINOVIĆ, Helena	KAR	2	USAINOVIĆ, Helena Džudo udruženje Karađorđević, Sokobanja
STANKOVIĆ, Aleksija	I10		
		3	

Rezultati

1. USAINOVIĆ, Helena KAR
2. STANKOVIĆ, Aleksija I10



SREĆNO 2023

Bor, 01.10.2023.

STARIJE POLETARKE

-28KG

4 takmičarki

TAKMIČAR I KLUB	1	2	3	4	POBEDA	BODOVA	MESTO
1 DRAGIĆEVIĆ, Dunja Aleksinac, Aleksinac		0	0	10	1	10	3
2 ANDREJEVIĆ, Tara Džudo udruženje Karađorđević, Sokobanja	10		10	10	3	30	1
3 SANDIĆ, Milica SU "Ipon 10", Pirot	10	0		10	2	20	2
4 ĐORĐEVIĆ, Neda Bor, Bor	0	0	0		0	0	3

DRAGIĆEVIĆ, Dunja	ALE	1	ANDREJEVIĆ, Tara
ANDREJEVIĆ, Tara	KAR		Džudo udruženje Karađorđević, Sokobanja
SANDIĆ, Milica	I10	2	SANDIĆ, Milica
ĐORĐEVIĆ, Neda	BOR		SU "Ipon 10", Pirot
DRAGIĆEVIĆ, Dunja	ALE	3	SANDIĆ, Milica
SANDIĆ, Milica	I10		SU "Ipon 10", Pirot
ANDREJEVIĆ, Tara	KAR	4	ANDREJEVIĆ, Tara
ĐORĐEVIĆ, Neda	BOR		Džudo udruženje Karađorđević, Sokobanja
DRAGIĆEVIĆ, Dunja	ALE	5	DRAGIĆEVIĆ, Dunja
ĐORĐEVIĆ, Neda	BOR		Aleksinac, Aleksinac
ANDREJEVIĆ, Tara	KAR	6	ANDREJEVIĆ, Tara
SANDIĆ, Milica	I10		Džudo udruženje Karađorđević, Sokobanja

Rezultati

1. ANDREJEVIĆ, Tara KAR
2. SANDIĆ, Milica I10
3. DRAGIĆEVIĆ, Dunja ALE
3. ĐORĐEVIĆ, Neda BOR

**SREĆNO 2023**

Bor, 01.10.2023.

STARIJE POLETARKE

-31KG

5 takmičarki

TAKMIČAR I KLUB	1	2	3	4	5	POBEDA	BODOVA	MESTO
1 KABAČ, Marija Bor, Bor	///	10	10	0	0	2	20	3
2 VUČKOVIĆ, Sara Partizan, Kraljevo	0	///	0	0	0	0	0	5
3 STANOJKOVIĆ, Petra Šogun, Niš	0	10	///	0	0	1	10	3
4 PETKOVIĆ, Milica Partizan, Beograd	10	10	10	///	10	4	40	1
5 STOJNIĆ, Darija Bor, Bor	10	10	10	0	///	3	30	2

KABAČ, Marija	BOR	1	KABAČ, Marija
VUČKOVIĆ, Sara	PKR		Bor, Bor
STANOJKOVIĆ, Petra	ŠOG	2	PETKOVIĆ, Milica
PETKOVIĆ, Milica	PBG		Partizan, Beograd
KABAČ, Marija	BOR	3	STOJNIĆ, Darija
STOJNIĆ, Darija	BOR		Bor, Bor
VUČKOVIĆ, Sara	PKR	4	STANOJKOVIĆ, Petra
STANOJKOVIĆ, Petra	ŠOG		Šogun, Niš
PETKOVIĆ, Milica	PBG	5	PETKOVIĆ, Milica
STOJNIĆ, Darija	BOR		Partizan, Beograd
KABAČ, Marija	BOR	6	KABAČ, Marija
STANOJKOVIĆ, Petra	ŠOG		Bor, Bor
VUČKOVIĆ, Sara	PKR	7	PETKOVIĆ, Milica
PETKOVIĆ, Milica	PBG		Partizan, Beograd
STANOJKOVIĆ, Petra	ŠOG	8	STOJNIĆ, Darija
STOJNIĆ, Darija	BOR		Bor, Bor
KABAČ, Marija	BOR	9	PETKOVIĆ, Milica
PETKOVIĆ, Milica	PBG		Partizan, Beograd
VUČKOVIĆ, Sara	PKR	10	STOJNIĆ, Darija
STOJNIĆ, Darija	BOR		Bor, Bor

Rezultati

- | | |
|-----------------------|-----|
| 1. PETKOVIĆ, Milica | PBG |
| 2. STOJNIĆ, Darija | BOR |
| 3. KABAČ, Marija | BOR |
| 3. STANOJKOVIĆ, Petra | ŠOG |
| 5. VUČKOVIĆ, Sara | PKR |



SREĆNO 2023

Bor, 01.10.2023.

STARIJE POLETARKE

-34KG

3 takmičarke

TAKMIČAR I KLUB	1	2	3	POBEDA	BODOVA	MESTO
1 JOSIFOSKA, Elenora Drim, Struga		0	10	1	10	2
2 GRUBJEŠIĆ, Nina Partizan, Beograd	10		10	2	20	1
3 MATOVIĆ, Marija Partizan, Kraljevo	0	0		0	0	3

JOSIFOSKA, Elenora	DRM	1	GRUBJEŠIĆ, Nina
GRUBJEŠIĆ, Nina	PBG		Partizan, Beograd
JOSIFOSKA, Elenora	DRM	2	JOSIFOSKA, Elenora
MATVIĆ, Marija	PKR		Drim, Struga
GRUBJEŠIĆ, Nina	PBG	3	GRUBJEŠIĆ, Nina
MATVIĆ, Marija	PKR		Partizan, Beograd

Rezultati

1. GRUBJEŠIĆ, Nina PBG
2. JOSIFOSKA, Elenora DRM
3. MATVIĆ, Marija PKR



SREĆNO 2023

Bor, 01.10.2023.

STARIJE POLETARKE

-38KG

3 takmičarke

TAKMIČAR I KLUB	1	2	3	POBEDA	BODOVA	MESTO
1 PETKOVIĆ, Milica Džudo udruženje Karađorđević, Sokobanja		0	0	0	0	3
2 STEVANOVIĆ, Andrea Bor, Bor	10		10	2	20	1
3 RAKIĆ, Sofija Vuk, Niš	10	0		1	10	2

PETKOVIĆ, Milica	KAR	1	STEVANOVIĆ, Andrea
STEVANOVIĆ, Andrea	BOR		Bor, Bor
PETKOVIĆ, Milica	KAR	2	RAKIĆ, Sofija
RAKIĆ, Sofija	VUK		Vuk, Niš
STEVANOVIĆ, Andrea	BOR	3	STEVANOVIĆ, Andrea
RAKIĆ, Sofija	VUK		Bor, Bor

Rezultati

1. STEVANOVIĆ, Andrea BOR
2. RAKIĆ, Sofija VUK
3. PETKOVIĆ, Milica KAR



SREĆNO 2023

Bor, 01.10.2023.

STARIJE POLETARKE

-43KG

3 takmičarke

TAKMIČAR I KLUB	1	2	3	POBEDA	BODOVA	MESTO
1 ILIĆ, Milena Brus, Brus		0	0	0	0	3
2 RAKIĆ, Sara SU "Ipon 10", Pirot	10		10	2	20	1
3 IVKOVIĆ, Dunja Aleksinac, Aleksinac	10	0		1	10	2

ILIĆ, Milena	BRU	1	RAKIĆ, Sara
RAKIĆ, Sara	I10		SU "Ipon 10", Pirot
ILIĆ, Milena	BRU	2	IVKOVIĆ, Dunja
IVKOVIĆ, Dunja	ALE		Aleksinac, Aleksinac
RAKIĆ, Sara	I10	3	RAKIĆ, Sara
IVKOVIĆ, Dunja	ALE		SU "Ipon 10", Pirot

Rezultati

1. RAKIĆ, Sara I10
2. IVKOVIĆ, Dunja ALE
3. ILIĆ, Milena BRU



SREĆNO 2023

Bor, 01.10.2023.

STARIJE POLETARKE

+43KG

7 takmičarki

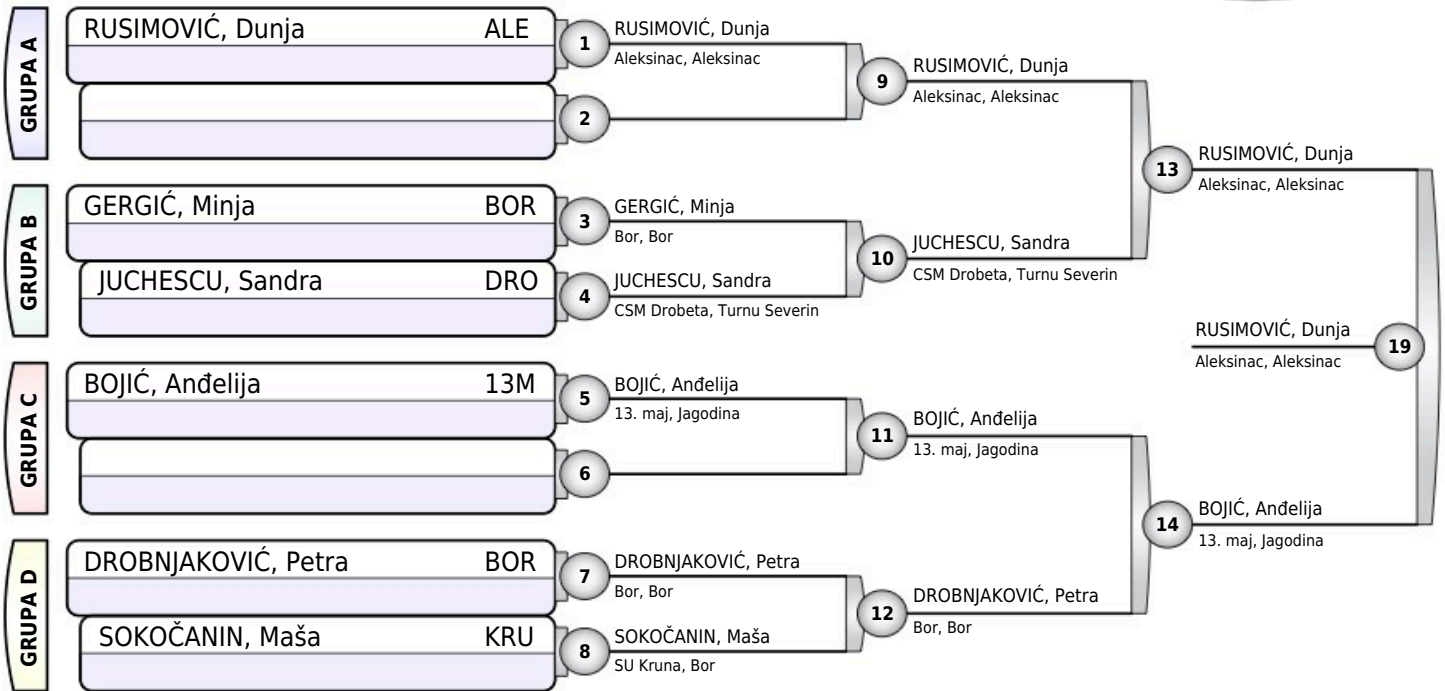

Rezultati

1. RUSIMOVIĆ, Dunja ALE
2. BOJIĆ, Anđelija 13M
3. JUCHESCU, Sandra DRO
3. DROBNJAKOVIĆ, Petra BOR
- 5.
- 5.
- 7.
- 7.

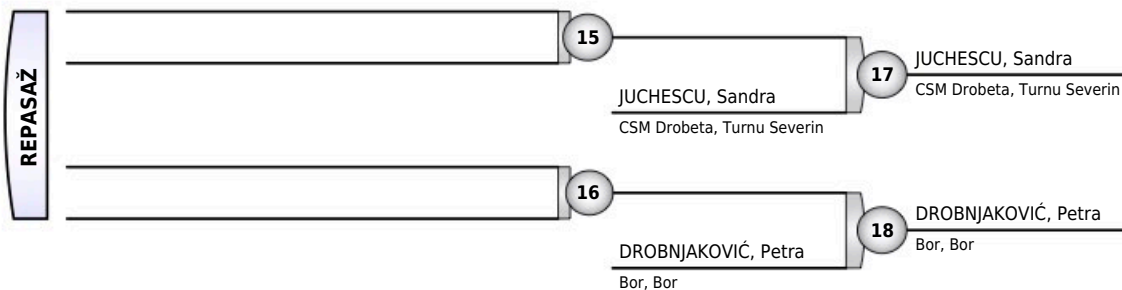



SREĆNO 2023

Bor, 01.10.2023.

MLAĐI DEČACI

-30KG

4 takmičara

TAKMIČAR I KLUB	1	2	3	4	POBEDA	BODOVA	MESTO
1 MILENKOVIĆ, Filip Akademija Todorović, Zaječar		0	0	0	0	0	3
2 STANKOVIĆ, Veljko Bor, Bor	10		10	10	3	30	1
3 ĐUROV, Nikola SU "Ipon 10", Pirot	10	0		0	1	10	3
4 ĆATIĆ, Nenad Kučevo, Kučevo	10	0	10		2	20	2

MILENKOVIĆ, Filip	AKT	1	STANKOVIĆ, Veljko
STANKOVIĆ, Veljko	BOR		Bor, Bor
ĐUROV, Nikola	I10	2	ĆATIĆ, Nenad
ĆATIĆ, Nenad	KUČ		Kučevo, Kučevo
MILENKOVIĆ, Filip	AKT	3	ĐUROV, Nikola
ĐUROV, Nikola	I10		SU "Ipon 10", Pirot
STANKOVIĆ, Veljko	BOR	4	STANKOVIĆ, Veljko
ĆATIĆ, Nenad	KUČ		Bor, Bor
MILENKOVIĆ, Filip	AKT	5	ĆATIĆ, Nenad
ĆATIĆ, Nenad	KUČ		Kučevo, Kučevo
STANKOVIĆ, Veljko	BOR	6	STANKOVIĆ, Veljko
ĐUROV, Nikola	I10		Bor, Bor

Rezultati

1. STANKOVIĆ, Veljko BOR
2. ĆATIĆ, Nenad KUČ
3. ĐUROV, Nikola I10
3. MILENKOVIĆ, Filip AKT



SREĆNO 2023

Bor, 01.10.2023.

MLAĐI DEČACI

-34KG

4 takmičara

TAKMIČAR I KLUB	1	2	3	4	POBEDA	BODOVA	MESTO
1 RANĐELOVIĆ, Andrej 13. maj, Jagodina	///	0	0	10	1	10	3
2 RISTIĆ, Uroš Džudo udruženje Karađorđević, Sokobanja	10	///	0	10	2	20	2
3 MITIĆ, Mijat SU "Akademija Ivezic", Niš	10	10	///	10	3	30	1
4 PETROVIĆ, Đorđe Vinča, Beograd	0	0	0	///	0	0	3

RANĐELOVIĆ, Andrej	13M	1	RISTIĆ, Uroš
RISTIĆ, Uroš	KAR		Džudo udruženje Karađorđević, Sokobanja
MITIĆ, Mijat	SUA	2	MITIĆ, Mijat
PETROVIĆ, Đorđe	VIN		SU "Akademija Ivezic", Niš
RANĐELOVIĆ, Andrej	13M	3	MITIĆ, Mijat
MITIĆ, Mijat	SUA		SU "Akademija Ivezic", Niš
RISTIĆ, Uroš	KAR	4	RISTIĆ, Uroš
PETROVIĆ, Đorđe	VIN		Džudo udruženje Karađorđević, Sokobanja
RANĐELOVIĆ, Andrej	13M	5	RANĐELOVIĆ, Andrej
PETROVIĆ, Đorđe	VIN		13. maj, Jagodina
RISTIĆ, Uroš	KAR	6	MITIĆ, Mijat
MITIĆ, Mijat	SUA		SU "Akademija Ivezic", Niš

Rezultati

- MITIĆ, Mijat SUA
- RISTIĆ, Uroš KAR
- RANĐELOVIĆ, Andrej 13M
- PETROVIĆ, Đorđe VIN



SREĆNO 2023

Bor, 01.10.2023.

MLAĐI DEČACI

-38KG

8 takmičara

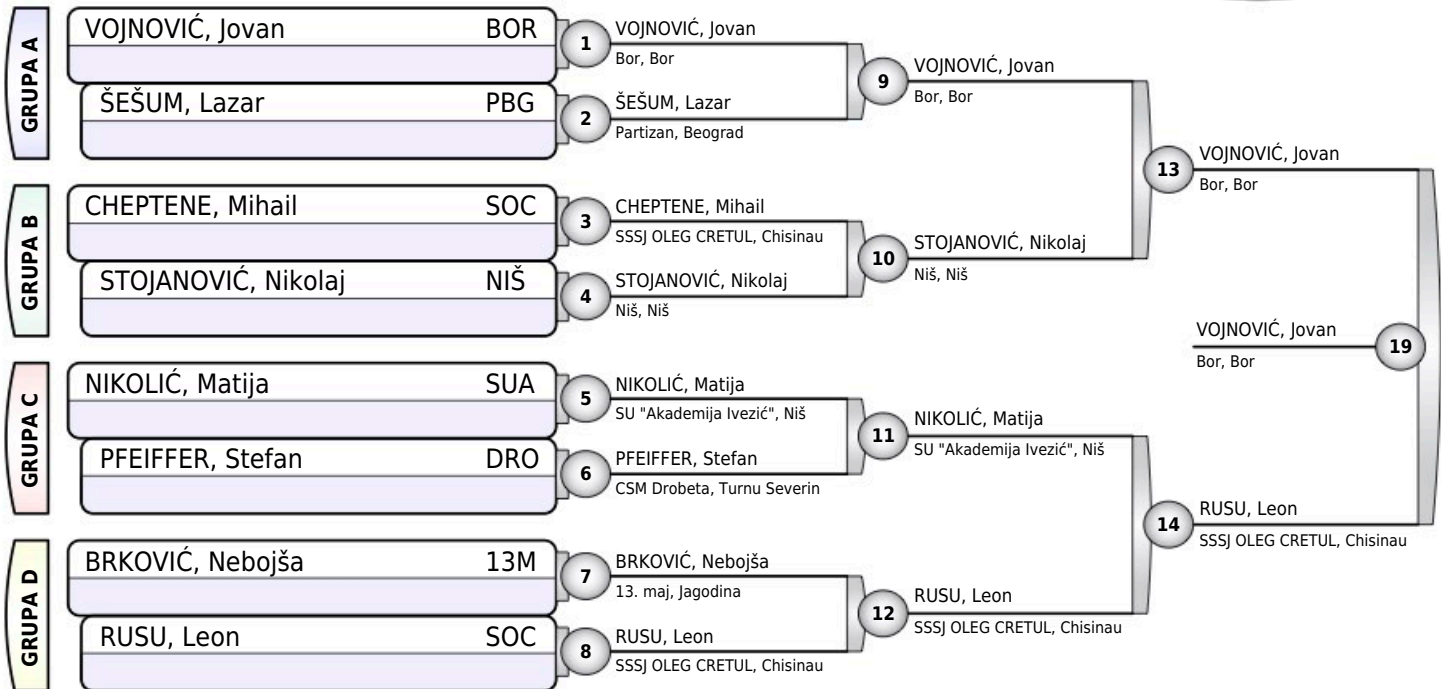

Rezultati

1. VOJNOVIĆ, Jovan BOR
2. RUSU, Leon SOC
3. ŠEŠUM, Lazar PBG
3. BRKOVIĆ, Nebojša 13M
5. STOJANOVIĆ, Nikolaj NIŠ
5. NIKOLIĆ, Matija SUA
- 7.
- 7.

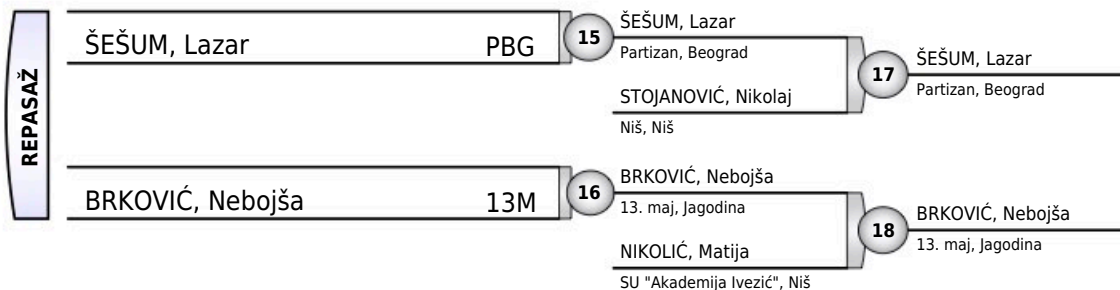



SREĆNO 2023

Bor, 01.10.2023.

MLAĐI DEČACI

-42KG

7 takmičara

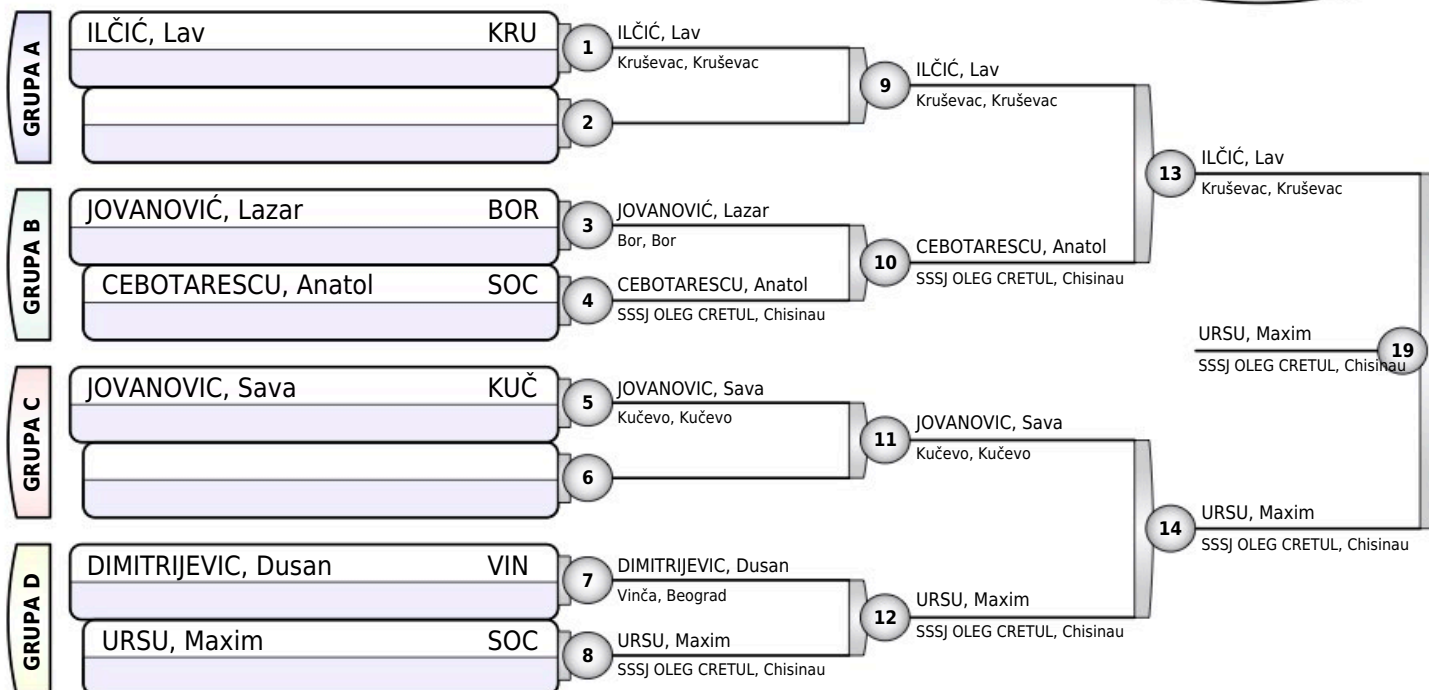

Rezultati

1. URSU, Maxim SOC
2. ILČIĆ, Lav KRU
3. CEBOTARESCU, Anatol SOC
3. DIMITRIJEVIC, Dusan VIN
5. JOVANOVIĆ, Sava KUČ
- 5.
- 7.
- 7.



SREĆNO 2023

Bor, 01.10.2023.

MLAĐI DEČACI

-46KG

3 takmičara

TAKMIČAR I KLUB	1	2	3	POBEDA	BODOVA	MESTO
1 STOJANOVIĆ, Mateja Mladost Carina, Smederevo		0	10	1	10	2
2 LIZDEK, Vuk Partizan, Beograd	10		10	2	20	1
3 OPRIĆ, Nikola Bor, Bor	0	0		0	0	3

STOJANOVIĆ, Mateja	MLC	1	LIZDEK, Vuk
LIZDEK, Vuk	PBG		Partizan, Beograd
STOJANOVIĆ, Mateja	MLC	2	STOJANOVIĆ, Mateja
OPRIĆ, Nikola	BOR		Mladost Carina, Smederevo
LIZDEK, Vuk	PBG	3	LIZDEK, Vuk
OPRIĆ, Nikola	BOR		Partizan, Beograd

Rezultati

- | | |
|-----------------------|-----|
| 1. LIZDEK, Vuk | PBG |
| 2. STOJANOVIĆ, Mateja | MLC |
| 3. OPRIĆ, Nikola | BOR |



SREĆNO 2023

Bor, 01.10.2023.

MLAĐI DEČACI

-50KG

5 takmičara

TAKMIČAR I KLUB	1	2	3	4	5	POBEDA	BODOVA	MESTO
1 KRSTEV, Erik Mioki, Skopje	///	10	10	1	10	4	31	1
2 ANDREJEVIĆ, Vuk Džudo udruženje Karađorđević, Sokobanja	0	///	10	10	0	2	20	3
3 ĆIRKOVIĆ, Filip SU "Akademija Ivezic", Niš	0	0	///	10	0	1	10	3
4 JANKOVIĆ, Andrej SU "Akademija Ivezic", Niš	0	0	0	///	0	0	0	5
5 ŠEŠUM, Stefan Partizan, Beograd	0	10	10	10	///	3	30	2

KRSTEV, Erik	MIO	1	KRSTEV, Erik
ANDREJEVIĆ, Vuk	KAR		Mioki, Skopje
ĆIRKOVIĆ, Filip	SUA	2	ĆIRKOVIĆ, Filip
JANKOVIĆ, Andrej	SUA		SU "Akademija Ivezic", Niš
KRSTEV, Erik	MIO	3	KRSTEV, Erik
ŠEŠUM, Stefan	PBG		Mioki, Skopje
ANDREJEVIĆ, Vuk	KAR	4	ANDREJEVIĆ, Vuk
ĆIRKOVIĆ, Filip	SUA		Džudo udruženje Karađorđević, Sokobanja
JANKOVIĆ, Andrej	SUA	5	ŠEŠUM, Stefan
ŠEŠUM, Stefan	PBG		Partizan, Beograd
KRSTEV, Erik	MIO	6	KRSTEV, Erik
ĆIRKOVIĆ, Filip	SUA		Mioki, Skopje
ANDREJEVIĆ, Vuk	KAR	7	ANDREJEVIĆ, Vuk
JANKOVIĆ, Andrej	SUA		Džudo udruženje Karađorđević, Sokobanja
ĆIRKOVIĆ, Filip	SUA	8	ŠEŠUM, Stefan
ŠEŠUM, Stefan	PBG		Partizan, Beograd
KRSTEV, Erik	MIO	9	KRSTEV, Erik
JANKOVIĆ, Andrej	SUA		Mioki, Skopje
ANDREJEVIĆ, Vuk	KAR	10	ŠEŠUM, Stefan
ŠEŠUM, Stefan	PBG		Partizan, Beograd

Rezultati

1. KRSTEV, Erik	MIO
2. ŠEŠUM, Stefan	PBG
3. ANDREJEVIĆ, Vuk	KAR
3. ĆIRKOVIĆ, Filip	SUA
5. JANKOVIĆ, Andrej	SUA



SREĆNO 2023

Bor, 01.10.2023.

MLAĐI DEČACI

-55KG

8 takmičara

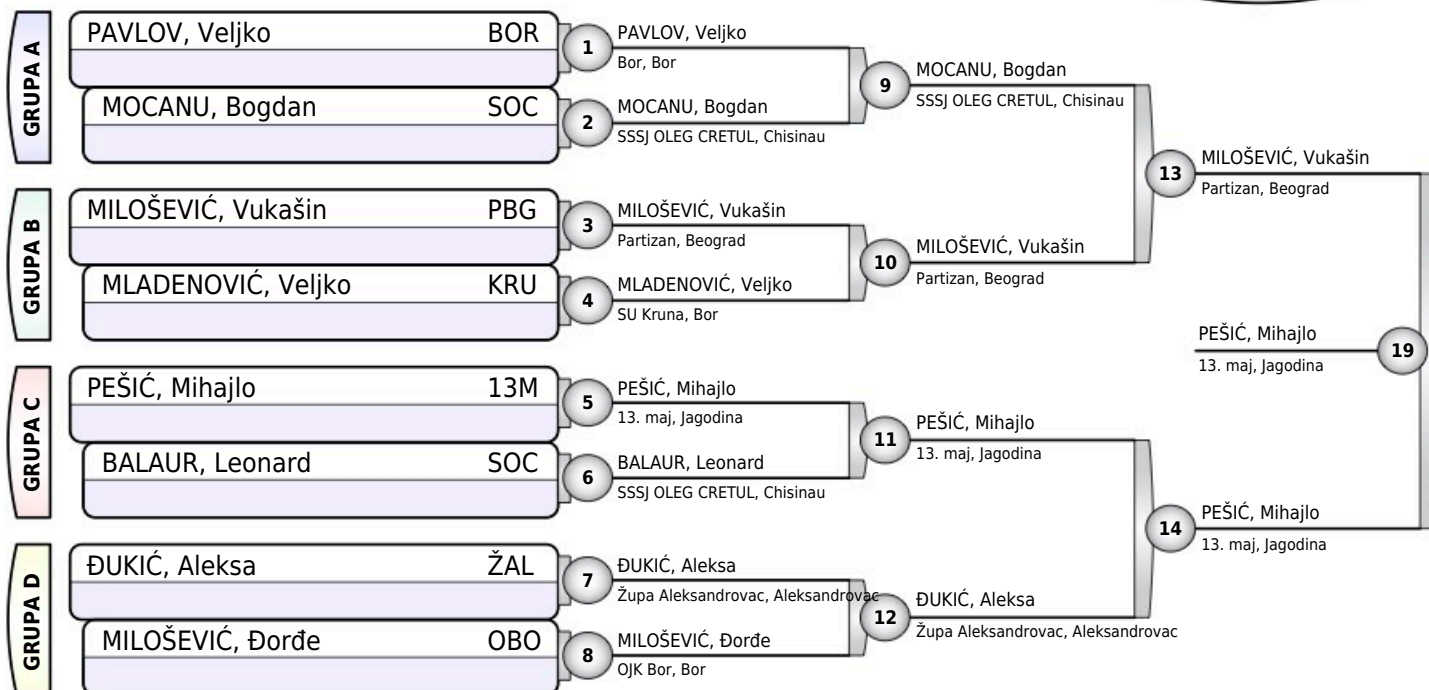

Rezultati

1. PEŠIĆ, Mihajlo 13M
2. MILOŠEVIĆ, Vukašin PBG
3. MOCANU, Bogdan SOC
3. ĐUKIĆ, Aleksa ŽAL
5. MLADENOVIĆ, Veljko KRU
5. BALAUR, Leonard SOC
- 7.
- 7.





SREĆNO 2023

Bor, 01.10.2023.

MLAĐI DEČACI

-60KG

3 takmičara

TAKMIČAR I KLUB	1	2	3	POBEDA	BODOVA	MESTO
1 JOKIĆ, Janko 13. maj, Jagodina		10	10	2	20	1
2 RADOVANOVIĆ, Kosta SU Kruna, Bor	0		10	1	10	2
3 ZLATANOVIĆ, Strahinja Kučevo, Kučevo	0	0		0	0	3

JOKIĆ, Janko	13M	1	JOKIĆ, Janko
RADOVANOVIĆ, Kosta	KRU		13. maj, Jagodina
JOKIĆ, Janko	13M	2	JOKIĆ, Janko
ZLATANOVIĆ, Strahinja	KUČ		13. maj, Jagodina
RADOVANOVIĆ, Kosta	KRU	3	RADOVANOVIĆ, Kosta
ZLATANOVIĆ, Strahinja	KUČ		SU Kruna, Bor

Rezultati

- JOKIĆ, Janko 13M
- RADOVANOVIĆ, Kosta KRU
- ZLATANOVIĆ, Strahinja KUČ



SREĆNO 2023

Bor, 01.10.2023.

MLAĐI DEČACI

-66KG

3 takmičara

TAKMIČAR I KLUB	1	2	3	POBEDA	BODOVA	MESTO
1 CHIRICA, David CSM Drobeta, Turnu Severin		10	0	1	10	2
2 JOVIĆ, Vukašin Bor, Bor	0		0	0	0	3
3 KNEŽEVIĆ, Andrej SU Kruna, Bor	10	10		2	20	1

CHIRICA, David	DRO	1	CHIRICA, David
JOVIĆ, Vukašin	BOR		CSM Drobeta, Turnu Severin
CHIRICA, David	DRO	2	KNEŽEVIĆ, Andrej
KNEŽEVIĆ, Andrej	KRU		SU Kruna, Bor
JOVIĆ, Vukašin	BOR	3	KNEŽEVIĆ, Andrej
KNEŽEVIĆ, Andrej	KRU		SU Kruna, Bor

Rezultati

1. KNEŽEVIĆ, Andrej KRU
2. CHIRICA, David DRO
3. JOVIĆ, Vukašin BOR



SREĆNO 2023

Bor, 01.10.2023.

MLAĐI DEČACI

+66KG

4 takmičara

TAKMIČAR I KLUB	1	2	3	4	POBEDA	BODOVA	MESTO
1 NIKOLIĆ, Marko SU "Ipon 10", Pirot		0	0	0	0	0	3
2 TOŠIĆ, Vuk SU "Ipon 10", Pirot	10		10	10	3	30	1
3 KOSTIĆ, Luka Brus, Brus	10	0		0	1	10	3
4 HADŽIĆ, Nikola 13. maj, Jagodina	10	0	10		2	20	2

NIKOLIĆ, Marko	I10	1	TOŠIĆ, Vuk
TOŠIĆ, Vuk	I10		SU "Ipon 10", Pirot
KOSTIĆ, Luka	BRU	2	HADŽIĆ, Nikola
HADŽIĆ, Nikola	13M		13. maj, Jagodina
NIKOLIĆ, Marko	I10	3	KOSTIĆ, Luka
KOSTIĆ, Luka	BRU		Brus, Brus
TOŠIĆ, Vuk	I10	4	TOŠIĆ, Vuk
HADŽIĆ, Nikola	13M		SU "Ipon 10", Pirot
NIKOLIĆ, Marko	I10	5	HADŽIĆ, Nikola
HADŽIĆ, Nikola	13M		13. maj, Jagodina
TOŠIĆ, Vuk	I10	6	TOŠIĆ, Vuk
KOSTIĆ, Luka	BRU		SU "Ipon 10", Pirot

Rezultati

1. TOŠIĆ, Vuk I10
2. HADŽIĆ, Nikola 13M
3. KOSTIĆ, Luka BRU
3. NIKOLIĆ, Marko I10



SREĆNO 2023

Bor, 01.10.2023.

MLAĐE DEVOJČICE

-32KG

2 takmičarke

ĐORĐEVIĆ, Dunja	NIŠ	1	NACIĆ, Katarina
NACIĆ, Katarina	I10		SU "Ipon 10", Pirot
ĐORĐEVIĆ, Dunja	NIŠ	2	ĐORĐEVIĆ, Dunja
NACIĆ, Katarina	I10		Niš, Niš
ĐORĐEVIĆ, Dunja	NIŠ	3	ĐORĐEVIĆ, Dunja
NACIĆ, Katarina	I10		Niš, Niš

Rezultati

1. ĐORĐEVIĆ, Dunja NIŠ
2. NACIĆ, Katarina I10



SREĆNO 2023

Bor, 01.10.2023.

MLAĐE DEVOJČICE

-36KG

1 takmičarka

KRSTIĆ, Tara

110

1

KRSTIĆ, Tara

SU "Ipon 10", Pirot

Rezultati

1. KRSTIĆ, Tara

110



SREĆNO 2023

Bor, 01.10.2023.

MLAĐE DEVOJČICE

-44KG

5 takmičarki

TAKMIČAR I KLUB	1	2	3	4	5	POBEDA	BODOVA	MESTO
1 JOVANOVIĆ, Milica Vinča, Beograd	---	0	0	0	0	0	0	5
2 NIKOLIĆ, Mia SU "Ipon 10", Pirot	10	---	10	10	10	4	40	1
3 SIMOVIĆ, Una Partizan, Beograd	10	0	---	0	10	2	20	3
4 PASKOSKA, Emilija Mioki, Skopje	10	0	1	---	10	3	21	2
5 BEŽANOVIĆ, Lena Župa Aleksandrovac, Aleksandrovac	10	0	0	0	---	1	10	3

JOVANOVIĆ, Milica	VIN	1	NIKOLIĆ, Mia
NIKOLIĆ, Mia	I10		SU "Ipon 10", Pirot
SIMOVIĆ, Una	PBG	2	PASKOSKA, Emilija
PASKOSKA, Emilija	MIO		Mioki, Skopje
JOVANOVIĆ, Milica	VIN	3	BEŽANOVIĆ, Lena
BEŽANOVIĆ, Lena	ŽAL		Župa Aleksandrovac, Aleksandrovac
NIKOLIĆ, Mia	I10	4	NIKOLIĆ, Mia
SIMOVIĆ, Una	PBG		SU "Ipon 10", Pirot
PASKOSKA, Emilija	MIO	5	PASKOSKA, Emilija
BEŽANOVIĆ, Lena	ŽAL		Mioki, Skopje
JOVANOVIĆ, Milica	VIN	6	SIMOVIĆ, Una
SIMOVIĆ, Una	PBG		Partizan, Beograd
NIKOLIĆ, Mia	I10	7	NIKOLIĆ, Mia
PASKOSKA, Emilija	MIO		SU "Ipon 10", Pirot
SIMOVIĆ, Una	PBG	8	SIMOVIĆ, Una
BEŽANOVIĆ, Lena	ŽAL		Partizan, Beograd
JOVANOVIĆ, Milica	VIN	9	PASKOSKA, Emilija
PASKOSKA, Emilija	MIO		Mioki, Skopje
NIKOLIĆ, Mia	I10	10	NIKOLIĆ, Mia
BEŽANOVIĆ, Lena	ŽAL		SU "Ipon 10", Pirot

Rezultati

1. NIKOLIĆ, Mia I10
2. PASKOSKA, Emilija MIO
3. SIMOVIĆ, Una PBG
3. BEŽANOVIĆ, Lena ŽAL
5. JOVANOVIĆ, Milica VIN



SREĆNO 2023

Bor, 01.10.2023.

MLAĐE DEVOJČICE

-48KG

7 takmičarki

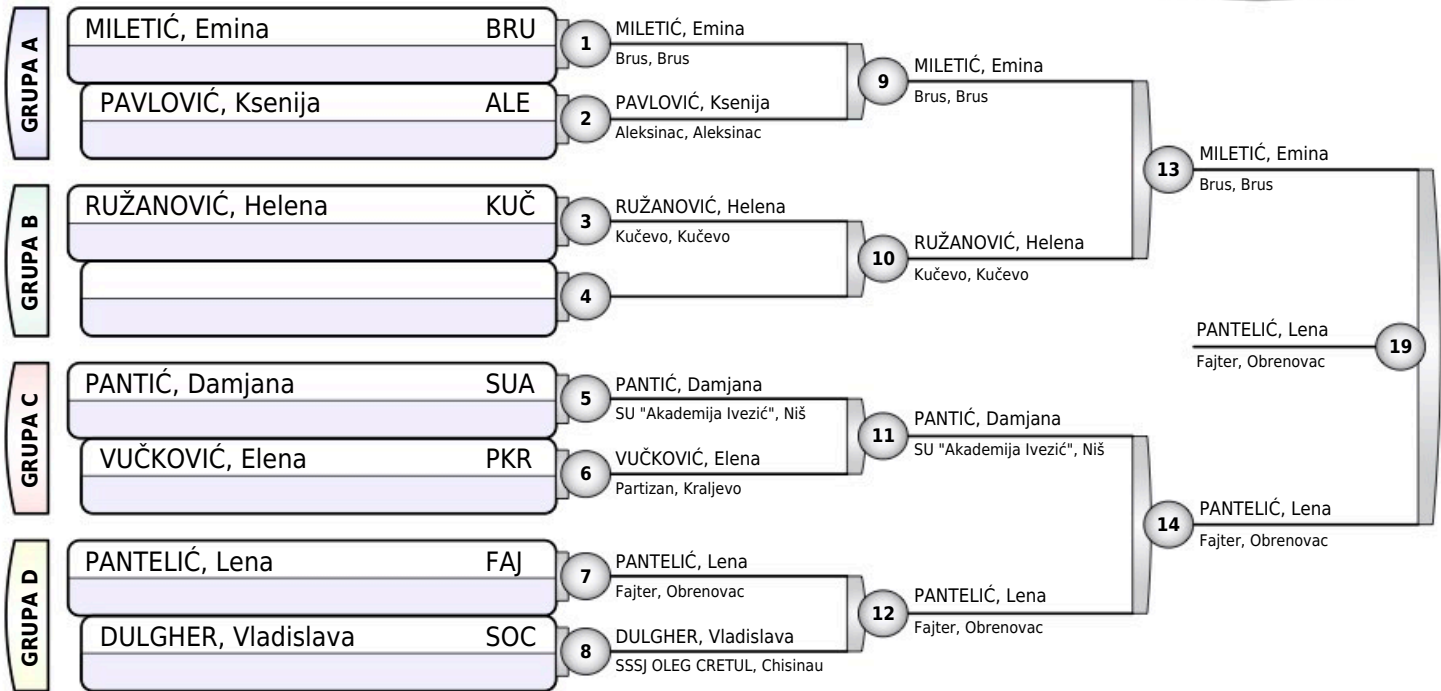

Rezultati

1. PANTELIĆ, Lena FAJ
2. MILETIĆ, Emina BRU
3. RUŽANOVIĆ, Helena KUČ
3. PANTIĆ, Damjana SUA
5. PAVLOVIĆ, Ksenija ALE
5. DULGHER, Vladislava SOC
- 7.
- 7.

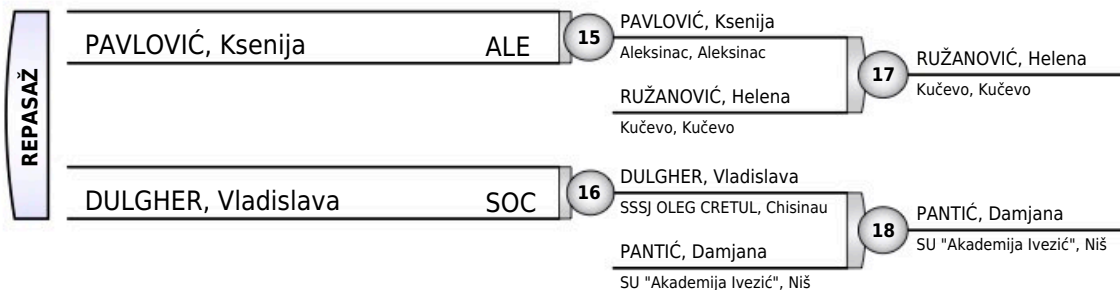



SREĆNO 2023

Bor, 01.10.2023.

MLAĐE DEVOJČICE

-52KG

4 takmičarki

TAKMIČAR I KLUB	1	2	3	4	POBEDA	BODOVA	MESTO
1 MOKRICKI, Lena Džudo udruženje Karadorđević, Sokobanja		0	0	0	0	0	3
2 RAKIĆ, Staša SU "Ipon 10", Pirot	10		0	0	1	10	3
3 CULICOVA, Anastasia SSSJ OLEG CRETUL, Chisinau	10	10		0	2	20	2
4 JAULEVSKA, Mishela Drim, Struga	10	10	10		3	30	1

MOKRICKI, Lena	KAR	1	RAKIĆ, Staša
RAKIĆ, Staša	I10		SU "Ipon 10", Pirot
CULICOVA, Anastasia	SOC	2	JAULEVSKA, Mishela
JAULEVSKA, Mishela	DRM		Drim, Struga
MOKRICKI, Lena	KAR	3	CULICOVA, Anastasia
CULICOVA, Anastasia	SOC		SSSJ OLEG CRETUL, Chisinau
RAKIĆ, Staša	I10	4	JAULEVSKA, Mishela
JAULEVSKA, Mishela	DRM		Drim, Struga
MOKRICKI, Lena	KAR	5	JAULEVSKA, Mishela
JAULEVSKA, Mishela	DRM		Drim, Struga
RAKIĆ, Staša	I10	6	CULICOVA, Anastasia
CULICOVA, Anastasia	SOC		SSSJ OLEG CRETUL, Chisinau

Rezultati

1. JAULEVSKA, Mishela DRM
2. CULICOVA, Anastasia SOC
3. RAKIĆ, Staša I10
3. MOKRICKI, Lena KAR



SREĆNO 2023

Bor, 01.10.2023.

MLAĐE DEVOJČICE

-56KG

2 takmičarke

JOVIĆ, Magdalena	KUČ	1	JOVIĆ, Magdalena Kučevo, Kučevo
PETROVIĆ, Teodora	I10		
JOVIĆ, Magdalena	KUČ	2	JOVIĆ, Magdalena Kučevo, Kučevo
PETROVIĆ, Teodora	I10		
		3	

Rezultati

1. JOVIĆ, Magdalena KUČ
2. PETROVIĆ, Teodora I10



SREĆNO 2023

Bor, 01.10.2023.

MLAĐE DEVOJČICE

+56KG

2 takmičarke

PANTELIĆ, Iva	FAJ	1	PANTELIĆ, Iva Fajter, Obrenovac
ŽIVANOVIĆ, Tijana	KAR		
PANTELIĆ, Iva	FAJ	2	PANTELIĆ, Iva Fajter, Obrenovac
ŽIVANOVIĆ, Tijana	KAR		
		3	

Rezultati

1. PANTELIĆ, Iva FAJ
2. ŽIVANOVIĆ, Tijana KAR



SREĆNO 2023

Bor, 01.10.2023.

STARIJI DEČACI

-38KG

3 takmičara

TAKMIČAR I KLUB	1	2	3	POBEDA	BODOVA	MESTO
1 NEŠIĆ, Mihajlo SU "Ipon 10", Piro		0	0	0	0	3
2 RANĐELOVIĆ, Stefan SU "Akademija Ivezic", Niš	10		10	2	20	1
3 BILBA, David SSSJ OLEG CRETUL, Chisinau	10	0		1	10	2

NEŠIĆ, Mihajlo	I10	1	RANĐELOVIĆ, Stefan
RANĐELOVIĆ, Stefan	SUA		SU "Akademija Ivezic", Niš
NEŠIĆ, Mihajlo	I10	2	BILBA, David
BILBA, David	SOC		SSSJ OLEG CRETUL, Chisinau
RANĐELOVIĆ, Stefan	SUA	3	RANĐELOVIĆ, Stefan
BILBA, David	SOC		SU "Akademija Ivezic", Niš

Rezultati

1. RANĐELOVIĆ, Stefan SUA
2. BILBA, David SOC
3. NEŠIĆ, Mihajlo I10



SREĆNO 2023

Bor, 01.10.2023.

STARIJI DEČACI

-42KG

3 takmičara

TAKMIČAR I KLUB	1	2	3	POBEDA	BODOVA	MESTO
1 CULICOV, Artiom SSSJ OLEG CRETUL, Chisinau		10	10	2	20	1
2 MARKOVIĆ, Vuk 13. maj, Jagodina	0		0	0	0	3
3 RISTIĆ, Strahinja Bor, Bor	0	10		1	10	2

CULICOV, Artiom	SOC	1	CULICOV, Artiom
MARKOVIĆ, Vuk	13M		SSSJ OLEG CRETUL, Chisinau
CULICOV, Artiom	SOC	2	CULICOV, Artiom
RISTIĆ, Strahinja	BOR		SSSJ OLEG CRETUL, Chisinau
MARKOVIĆ, Vuk	13M	3	RISTIĆ, Strahinja
RISTIĆ, Strahinja	BOR		Bor, Bor

Rezultati

1. CULICOV, Artiom SOC
2. RISTIĆ, Strahinja BOR
3. MARKOVIĆ, Vuk 13M



SREĆNO 2023

Bor, 01.10.2023.

STARIJI DEČACI

-46KG

8 takmičara

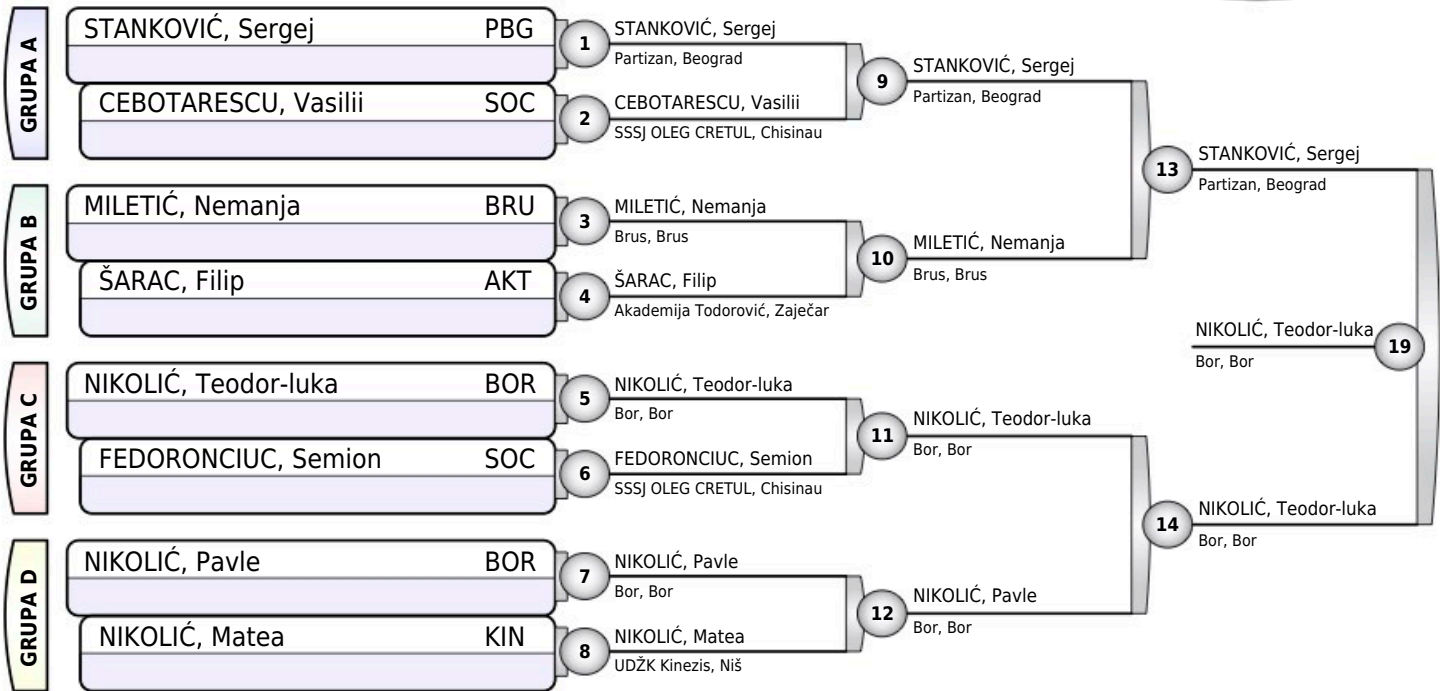

Rezultati

1. NIKOLIĆ, Teodor-luka BOR
2. STANKOVIĆ, Sergej PBG
3. CEBOTARESCU, Vasilii SOC
3. FEDORONCIUC, Semion SOC
5. MILETIĆ, Nemanja BRU
5. NIKOLIĆ, Pavle BOR
- 7.
- 7.

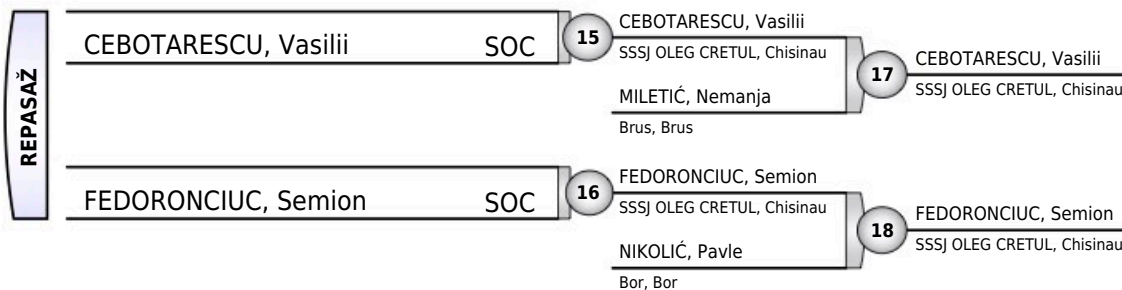



SREĆNO 2023

Bor, 01.10.2023.

STARIJI DEČACI

-50KG

6 takmičara

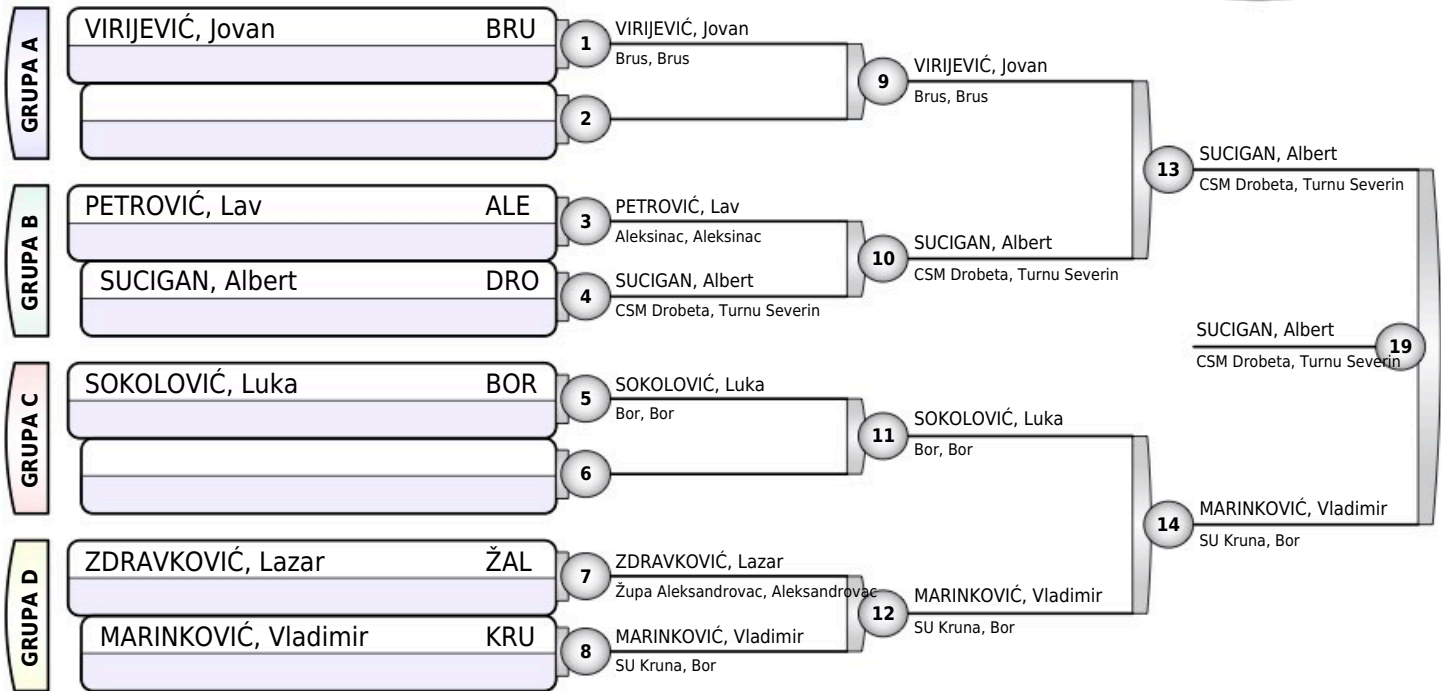

Rezultati

1. SUCIGAN, Albert DRO
2. MARINKOVIĆ, Vladimir KRU
3. PETROVIĆ, Lav ALE
3. ZDRAVKOVIĆ, Lazar ŽAL
5. VIRIJEVIĆ, Jovan BRU
5. SOKOLOVIĆ, Luka BOR
- 7.
- 7.



SREĆNO 2023

Bor, 01.10.2023.

STARIJI DEČACI

-55KG

4 takmičara

TAKMIČAR I KLUB	1	2	3	4	POBEDA	BODOVA	MESTO
1 DOBRIAN, Nicolai SSSJ OLEG CRETUL, Chisinau		10	0	0	1	10	3
2 STEPIĆ, Aleksa Fajter, Obrenovac	0		0	10	1	10	2
3 STANKOVIĆ, Ilija Vinča, Beograd	10	10		10	3	30	1
4 LEŠINGER, David Bambi, Požarevac	10	0	0		1	10	3

DOBRIAN, Nicolai	SOC	1	DOBRIAN, Nicolai
STEPIĆ, Aleksa	FAJ		SSSJ OLEG CRETUL, Chisinau
STANKOVIĆ, Ilija	VIN	2	STANKOVIĆ, Ilija
LEŠINGER, David	BAM		Vinča, Beograd
DOBRIAN, Nicolai	SOC	3	STANKOVIĆ, Ilija
STANKOVIĆ, Ilija	VIN		Vinča, Beograd
STEPIĆ, Aleksa	FAJ	4	STEPIĆ, Aleksa
LEŠINGER, David	BAM		Fajter, Obrenovac
DOBRIAN, Nicolai	SOC	5	LEŠINGER, David
LEŠINGER, David	BAM		Bambi, Požarevac
STEPIĆ, Aleksa	FAJ	6	STANKOVIĆ, Ilija
STANKOVIĆ, Ilija	VIN		Vinča, Beograd

Rezultati

1. STANKOVIĆ, Ilija VIN
2. STEPIĆ, Aleksa FAJ
3. LEŠINGER, David BAM
3. DOBRIAN, Nicolai SOC



SREĆNO 2023

Bor, 01.10.2023.

STARIJI DEČACI

-60KG

9 takmičara

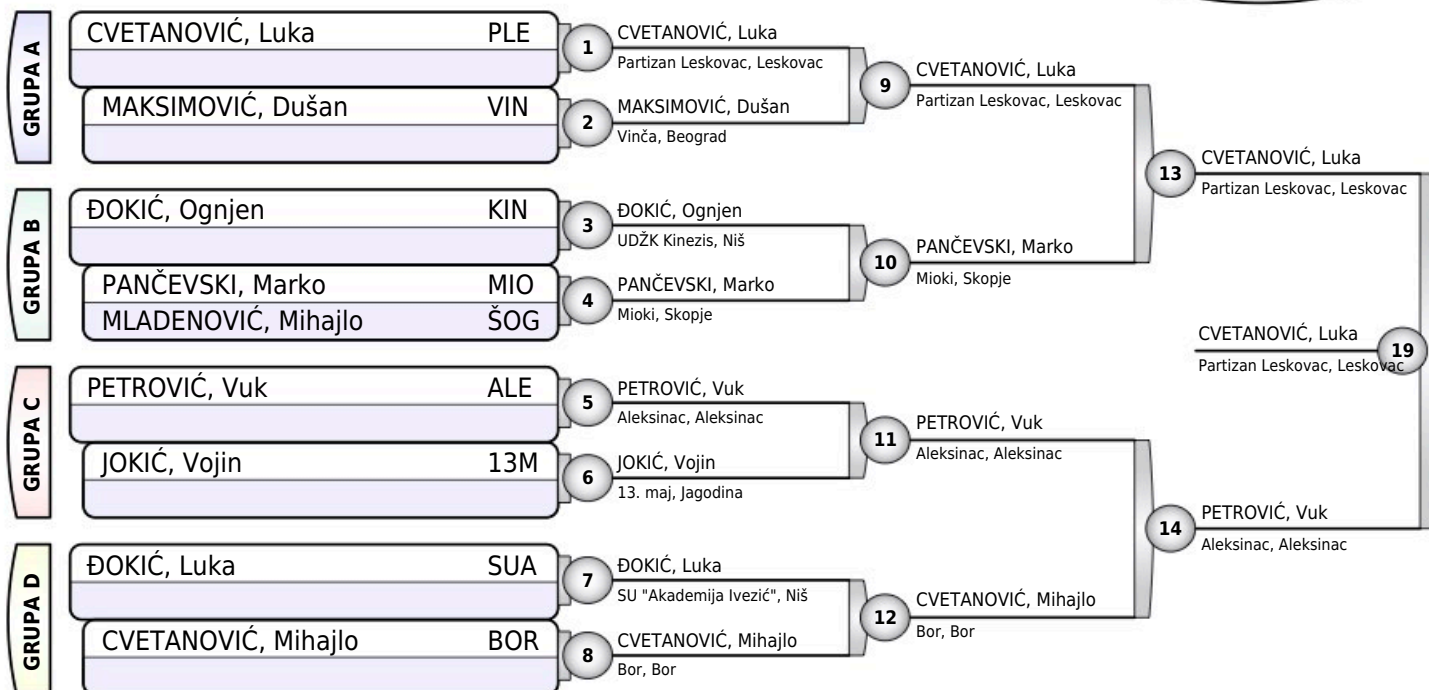

Rezultati

1. CVETANOVIĆ, Luka PLE
2. PETROVIĆ, Vuk ALE
3. PANČEVSKI, Marko MIO
3. CVETANOVIĆ, Mihajlo BOR
5. MAKSIMOVIĆ, Dušan VIN
5. JOKIĆ, Vojin 13M
- 7.
- 7.

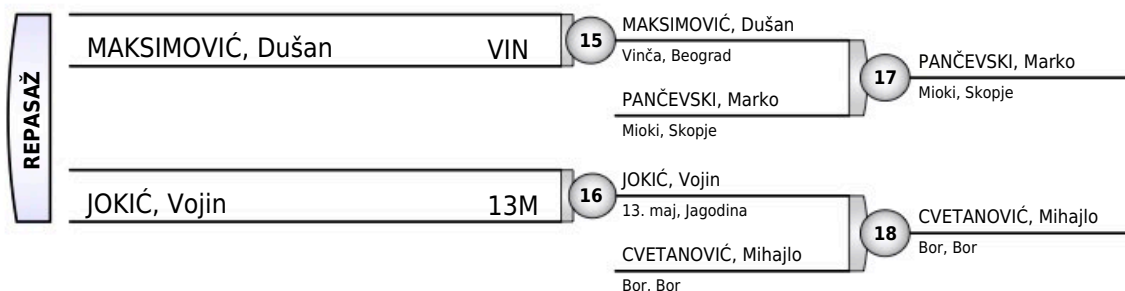



SREĆNO 2023

Bor, 01.10.2023.

STARIJI DEČACI

-66KG

8 takmičara

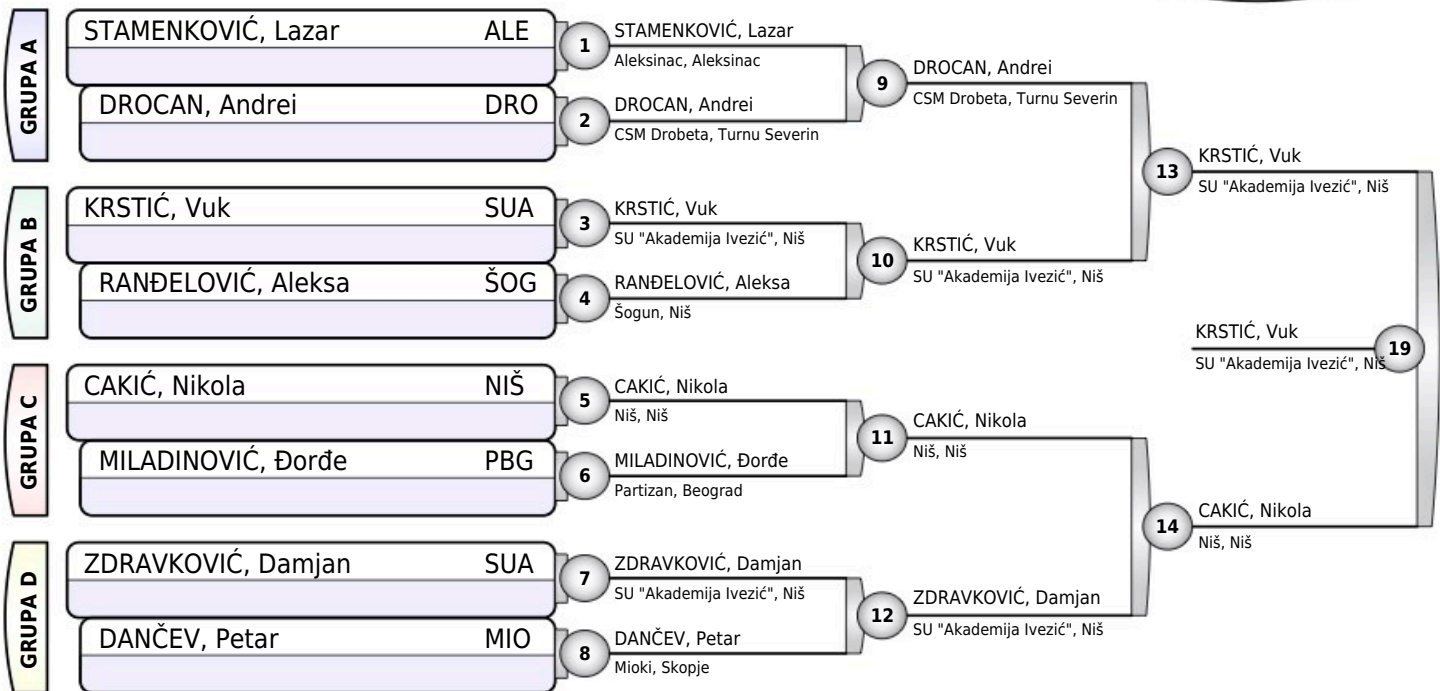

Rezultati

1. KRSTIĆ, Vuk SUA
2. CAKIĆ, Nikola NIŠ
3. DROCAN, Andrei DRO
3. ZDRAVKOVIĆ, Damjan SUA
5. RANĐELOVIĆ, Aleksa ŠOG
5. MILADINOVIĆ, Đorđe PBG
- 7.
- 7.

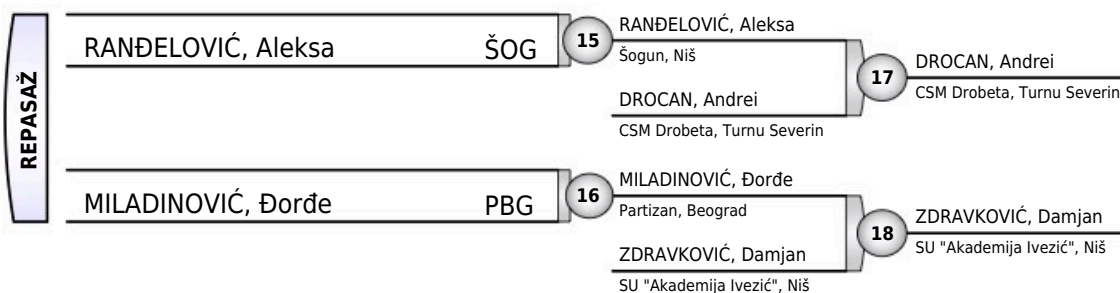



SREĆNO 2023

Bor, 01.10.2023.

STARIJI DEČACI

-73KG

3 takmičara

TAKMIČAR I KLUB	1	2	3	POBEDA	BODOVA	MESTO
1 ARITONOVIĆ, Nikola SU Kruna, Bor		10	10	2	20	1
2 SJEKLOČA, Strahinja 13. maj, Jagodina	0		10	1	10	2
3 APOSTOLOVIĆ, Đorđe 13. maj, Jagodina	0	0		0	0	3

ARITONOVIĆ, Nikola	KRU	1	ARITONOVIĆ, Nikola
SJEKLOČA, Strahinja	13M		SU Kruna, Bor
ARITONOVIĆ, Nikola	KRU	2	ARITONOVIĆ, Nikola
APOSTOLOVIĆ, Đorđe	13M		SU Kruna, Bor
SJEKLOČA, Strahinja	13M	3	SJEKLOČA, Strahinja
APOSTOLOVIĆ, Đorđe	13M		13. maj, Jagodina

Rezultati

1. ARITONOVIĆ, Nikola KRU
2. SJEKLOČA, Strahinja 13M
3. APOSTOLOVIĆ, Đorđe 13M



SREĆNO 2023

Bor, 01.10.2023.

STARIJI DEČACI

+73KG

5 takmičara

TAKMIČAR I KLUB	1	2	3	4	5	POBEDA	BODOVA	MESTO
1 IVANOV, Ivo Olimpiya, Kozloduy		0	0	0	0	0	0	5
2 RUSIMOVIĆ, Lazar Aleksinac, Aleksinac	10		10	10	0	3	30	2
3 BUZEJIĆ, Nikola Bor, Bor	10	0		1	0	2	11	3
4 TRAJKOVIĆ, Luka Aleksinac, Aleksinac	10	0	0		0	1	10	3
5 TASIĆ, Vujadin UDŽK Kinezis, Niš	10	10	10	10		4	40	1

IVANOV, Ivo	OLI	1	RUSIMOVIĆ, Lazar
RUSIMOVIĆ, Lazar	ALE		Aleksinac, Aleksinac
BUZEJIĆ, Nikola	BOR	2	BUZEJIĆ, Nikola
TRAJKOVIĆ, Luka	ALE		Bor, Bor
IVANOV, Ivo	OLI	3	TASIĆ, Vujadin
TASIĆ, Vujadin	KIN		UDŽK Kinezis, Niš
RUSIMOVIĆ, Lazar	ALE	4	RUSIMOVIĆ, Lazar
BUZEJIĆ, Nikola	BOR		Aleksinac, Aleksinac
TRAJKOVIĆ, Luka	ALE	5	TASIĆ, Vujadin
TASIĆ, Vujadin	KIN		UDŽK Kinezis, Niš
IVANOV, Ivo	OLI	6	BUZEJIĆ, Nikola
BUZEJIĆ, Nikola	BOR		Bor, Bor
RUSIMOVIĆ, Lazar	ALE	7	RUSIMOVIĆ, Lazar
TRAJKOVIĆ, Luka	ALE		Aleksinac, Aleksinac
BUZEJIĆ, Nikola	BOR	8	TASIĆ, Vujadin
TASIĆ, Vujadin	KIN		UDŽK Kinezis, Niš
IVANOV, Ivo	OLI	9	TRAJKOVIĆ, Luka
TRAJKOVIĆ, Luka	ALE		Aleksinac, Aleksinac
RUSIMOVIĆ, Lazar	ALE	10	TASIĆ, Vujadin
TASIĆ, Vujadin	KIN		UDŽK Kinezis, Niš

Rezultati

- | | |
|---------------------|-----|
| 1. TASIĆ, Vujadin | KIN |
| 2. RUSIMOVIĆ, Lazar | ALE |
| 3. BUZEJIĆ, Nikola | BOR |
| 3. TRAJKOVIĆ, Luka | ALE |
| 5. IVANOV, Ivo | OLI |



SREĆNO 2023

Bor, 01.10.2023.

STARIJE DEVOJČICE

-40KG

2 takmičarke

DRUŠTINAC, Hamida	MIO	1	DRUŠTINAC, Hamida Mioki, Skopje
JABER, Rana	SOC		
DRUŠTINAC, Hamida	MIO	2	DRUŠTINAC, Hamida Mioki, Skopje
JABER, Rana	SOC		
		3	

Rezultati

1. DRUŠTINAC, Hamida MIO
2. JABER, Rana SOC



SREĆNO 2023

Bor, 01.10.2023.

STARIJE DEVOJČICE

-44KG

4 takmičarki

TAKMIČAR I KLUB	1	2	3	4	POBEDA	BODOVA	MESTO
1 KRAJNJANOVIĆ, Sara Bor, Bor		0	10	0	1	10	3
2 BLAGOJEVIĆ, Nađa Kučevo, Kučevo	10		0	0	1	10	3
3 PANTIĆ, Teodora Partizan, Beograd	0	10		10	2	20	1
4 GOJKOVIĆ, Iva Vuk, Niš	10	10	0		2	20	2

KRAJNJANOVIĆ, Sara	BOR	1	BLAGOJEVIĆ, Nađa
BLAGOJEVIĆ, Nađa	KUČ		Kučevo, Kučevo
PANTIĆ, Teodora	PBG	2	PANTIĆ, Teodora
GOJKOVIĆ, Iva	VUK		Partizan, Beograd
KRAJNJANOVIĆ, Sara	BOR	3	KRAJNJANOVIĆ, Sara
PANTIĆ, Teodora	PBG		Bor, Bor
BLAGOJEVIĆ, Nađa	KUČ	4	GOJKOVIĆ, Iva
GOJKOVIĆ, Iva	VUK		Vuk, Niš
KRAJNJANOVIĆ, Sara	BOR	5	GOJKOVIĆ, Iva
GOJKOVIĆ, Iva	VUK		Vuk, Niš
BLAGOJEVIĆ, Nađa	KUČ	6	PANTIĆ, Teodora
PANTIĆ, Teodora	PBG		Partizan, Beograd

Rezultati

1. PANTIĆ, Teodora PBG
2. GOJKOVIĆ, Iva VUK
3. BLAGOJEVIĆ, Nađa KUČ
3. KRAJNJANOVIĆ, Sara BOR



SREĆNO 2023

Bor, 01.10.2023.

STARIJE DEVOJČICE

-48KG

4 takmičarki

TAKMIČAR I KLUB	1	2	3	4	POBEDA	BODOVA	MESTO
1 PETKOVA, Aksinia Slava-83, Montana		0	10	10	2	20	2
2 NIĆIFOROVIĆ, Đurđa 13. maj, Jagodina	10		10	10	3	30	1
3 ŽIVANOVIĆ, Lena Kučevo, Kučevo	0	0		10	1	10	3
4 MILIVOJEVIĆ, Mitra Kruševac, Kruševac	0	0	0		0	0	3

PETKOVA, Aksinia	SLA	1	NIĆIFOROVIĆ, Đurđa
NIĆIFOROVIĆ, Đurđa	13M		13. maj, Jagodina
ŽIVANOVIĆ, Lena	KUČ	2	ŽIVANOVIĆ, Lena
MILIVOJEVIĆ, Mitra	KRU		Kučevo, Kučevo
PETKOVA, Aksinia	SLA	3	PETKOVA, Aksinia
ŽIVANOVIĆ, Lena	KUČ		Slava-83, Montana
NIĆIFOROVIĆ, Đurđa	13M	4	NIĆIFOROVIĆ, Đurđa
MILIVOJEVIĆ, Mitra	KRU		13. maj, Jagodina
PETKOVA, Aksinia	SLA	5	PETKOVA, Aksinia
MILIVOJEVIĆ, Mitra	KRU		Slava-83, Montana
NIĆIFOROVIĆ, Đurđa	13M	6	NIĆIFOROVIĆ, Đurđa
ŽIVANOVIĆ, Lena	KUČ		13. maj, Jagodina

Rezultati

1. NIĆIFOROVIĆ, Đurđa 13M
2. PETKOVA, Aksinia SLA
3. ŽIVANOVIĆ, Lena KUČ
3. MILIVOJEVIĆ, Mitra KRU



SREĆNO 2023

Bor, 01.10.2023.

STARIJE DEVOJČICE

-52KG

4 takmičarki

TAKMIČAR I KLUB	1	2	3	4	POBEDA	BODOVA	MESTO
1 POTIĆ, Maša SU "Ipon 10", Pirot		0	10	0	1	10	3
2 MILIJIĆ, Neda Džudo udruženje Karađorđević, Sokobanja	1		10	10	3	21	1
3 DUŠANIĆ, Dunja OJK Bor, Bor	0	0		0	0	0	3
4 ALEKSIEVA, Lora Slava-83, Montana	10	0	10		2	20	2

POTIĆ, Maša	I10	1	MILIJIĆ, Neda
MILIJIĆ, Neda	KAR		Džudo udruženje Karađorđević, Sokobanja
DUŠANIĆ, Dunja	OBO	2	ALEKSIEVA, Lora
ALEKSIEVA, Lora	SLA		Slava-83, Montana
POTIĆ, Maša	I10	3	POTIĆ, Maša
DUŠANIĆ, Dunja	OBO		SU "Ipon 10", Pirot
MILIJIĆ, Neda	KAR	4	MILIJIĆ, Neda
ALEKSIEVA, Lora	SLA		Džudo udruženje Karađorđević, Sokobanja
POTIĆ, Maša	I10	5	ALEKSIEVA, Lora
ALEKSIEVA, Lora	SLA		Slava-83, Montana
MILIJIĆ, Neda	KAR	6	MILIJIĆ, Neda
DUŠANIĆ, Dunja	OBO		Džudo udruženje Karađorđević, Sokobanja

Rezultati

- MILIJIĆ, Neda KAR
- ALEKSIEVA, Lora SLA
- POTIĆ, Maša I10
- DUŠANIĆ, Dunja OBO



SREĆNO 2023

Bor, 01.10.2023.

STARIJE DEVOJČICE

-57KG

4 takmičarki

TAKMIČAR I KLUB	1	2	3	4	POBEDA	BODOVA	MESTO
1 TODOROVIĆ, Nikolija UDŽK Kinezis, Niš		0	10	0	1	10	3
2 RISTIĆ, Petra Aleksinac, Aleksinac	10		10	0	2	20	2
3 PEJIĆ, Mila UDŽK Kinezis, Niš	0	0		0	0	0	3
4 MIJALKOVIĆ, Lara Vinča, Beograd	10	10	10		3	30	1

TODOROVIĆ, Nikolija	KIN	1	RISTIĆ, Petra
RISTIĆ, Petra	ALE		Aleksinac, Aleksinac
PEJIĆ, Mila	KIN	2	MIJALKOVIĆ, Lara
MIJALKOVIĆ, Lara	VIN		Vinča, Beograd
TODOROVIĆ, Nikolija	KIN	3	TODOROVIĆ, Nikolija
PEJIĆ, Mila	KIN		UDŽK Kinezis, Niš
RISTIĆ, Petra	ALE	4	MIJALKOVIĆ, Lara
MIJALKOVIĆ, Lara	VIN		Vinča, Beograd
TODOROVIĆ, Nikolija	KIN	5	MIJALKOVIĆ, Lara
MIJALKOVIĆ, Lara	VIN		Vinča, Beograd
RISTIĆ, Petra	ALE	6	RISTIĆ, Petra
PEJIĆ, Mila	KIN		Aleksinac, Aleksinac

Rezultati

- | | |
|------------------------|-----|
| 1. MIJALKOVIĆ, Lara | VIN |
| 2. RISTIĆ, Petra | ALE |
| 3. TODOROVIĆ, Nikolija | KIN |
| 3. PEJIĆ, Mila | KIN |



SREĆNO 2023

Bor, 01.10.2023.

STARIJE DEVOJČICE

-63KG

5 takmičarki

TAKMIČAR I KLUB	1	2	3	4	5	POBEDA	BODOVA	MESTO
1 RAFTOSKA, Dragica Drim, Struga	---	0	0	10	0	1	10	3
2 ĐORĐEVIĆ, Mila Šogun, Niš	10	---	0	10	10	3	30	2
3 ĐOKIĆ, Elena UDŽK Kinezis, Niš	10	10	---	10	10	4	40	1
4 GEORGIEVA, Emilia Slava-83, Montana	0	0	0	---	0	0	0	5
5 SIMOVIĆ, Milica Partizan, Beograd	10	0	0	10	---	2	20	3

RAFTOSKA, Dragica	DRM	1	ĐORĐEVIĆ, Mila
ĐORĐEVIĆ, Mila	ŠOG		Šogun, Niš
ĐOKIĆ, Elena	KIN	2	ĐOKIĆ, Elena
GEORGIEVA, Emilia	SLA		UDŽK Kinezis, Niš
RAFTOSKA, Dragica	DRM	3	SIMOVIĆ, Milica
SIMOVIĆ, Milica	PBG		Partizan, Beograd
ĐORĐEVIĆ, Mila	ŠOG	4	ĐOKIĆ, Elena
ĐOKIĆ, Elena	KIN		UDŽK Kinezis, Niš
GEORGIEVA, Emilia	SLA	5	SIMOVIĆ, Milica
SIMOVIĆ, Milica	PBG		Partizan, Beograd
RAFTOSKA, Dragica	DRM	6	ĐOKIĆ, Elena
ĐOKIĆ, Elena	KIN		UDŽK Kinezis, Niš
ĐORĐEVIĆ, Mila	ŠOG	7	ĐORĐEVIĆ, Mila
GEORGIEVA, Emilia	SLA		Šogun, Niš
ĐOKIĆ, Elena	KIN	8	ĐOKIĆ, Elena
SIMOVIĆ, Milica	PBG		UDŽK Kinezis, Niš
RAFTOSKA, Dragica	DRM	9	RAFTOSKA, Dragica
GEORGIEVA, Emilia	SLA		Drim, Struga
ĐORĐEVIĆ, Mila	ŠOG	10	ĐORĐEVIĆ, Mila
SIMOVIĆ, Milica	PBG		Šogun, Niš

Rezultati

- | | |
|----------------------|-----|
| 1. ĐOKIĆ, Elena | KIN |
| 2. ĐORĐEVIĆ, Mila | ŠOG |
| 3. SIMOVIĆ, Milica | PBG |
| 3. RAFTOSKA, Dragica | DRM |
| 5. GEORGIEVA, Emilia | SLA |



SREĆNO 2023

Bor, 01.10.2023.

STARIJE DEVOJČICE

+63KG

4 takmičarki

TAKMIČAR I KLUB	1	2	3	4	POBEDA	BODOVA	MESTO
1 PAUNOVIĆ, Helena Kučevo, Kučevo		0	10	10	2	20	2
2 IVANOVIĆ, Nikolina Mladost Carina, Smederevo	10		10	10	3	30	1
3 IVANOVIĆ, Anastasija Mladost Carina, Smederevo	0	0		10	1	10	3
4 ILIEVA, Joana Slava-83, Montana	0	0	0		0	0	3

PAUNOVIĆ, Helena	KUČ	1	IVANOVIĆ, Nikolina
IVANOVIĆ, Nikolina	MLC		Mladost Carina, Smederevo
IVANOVIĆ, Anastasija	MLC	2	IVANOVIĆ, Anastasija
ILIEVA, Joana	SLA		Mladost Carina, Smederevo
PAUNOVIĆ, Helena	KUČ	3	PAUNOVIĆ, Helena
IVANOVIĆ, Anastasija	MLC		Kučevo, Kučevo
IVANOVIĆ, Nikolina	MLC	4	IVANOVIĆ, Nikolina
ILIEVA, Joana	SLA		Mladost Carina, Smederevo
PAUNOVIĆ, Helena	KUČ	5	PAUNOVIĆ, Helena
ILIEVA, Joana	SLA		Kučevo, Kučevo
IVANOVIĆ, Nikolina	MLC	6	IVANOVIĆ, Nikolina
IVANOVIĆ, Anastasija	MLC		Mladost Carina, Smederevo

Rezultati

1. IVANOVIĆ, Nikolina MLC
2. PAUNOVIĆ, Helena KUČ
3. IVANOVIĆ, Anastasija MLC
3. ILIEVA, Joana SLA