

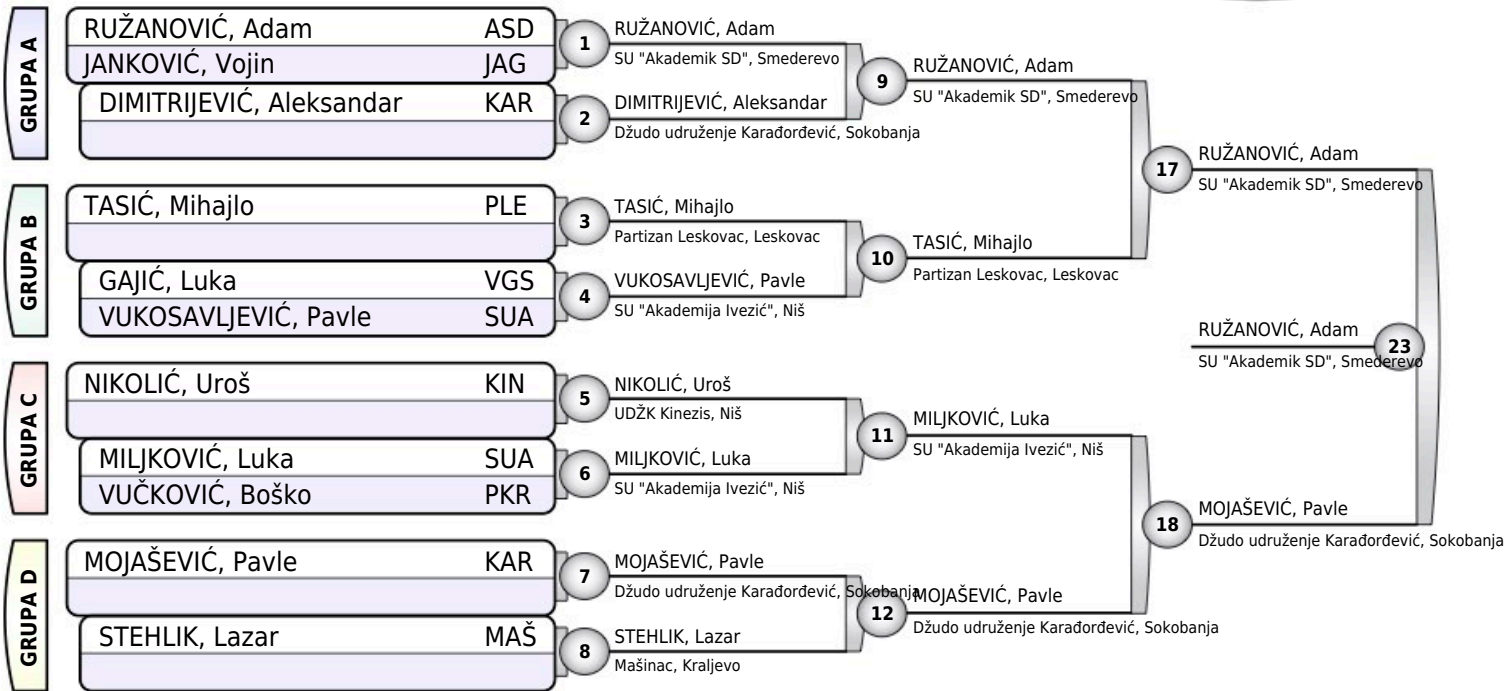

# REGIONALNO CS M.DEČACI

Aleksandrovac, 04.04.2026.

Mlađi dečaci  
**-30KG**  
12 takmičara



## Rezultati

1. RUŽANOVIĆ, Adam ASD
2. MOJAŠEVIĆ, Pavle KAR
3. MILJKOVIĆ, Luka SUA
3. TASIĆ, Mihajlo PLE
5. JANKOVIĆ, Vojin JAG
5. NIKOLIĆ, Uroš KIN
7. VUKOSAVLJEVIĆ, Pavle SUA
7. STEHLIK, Lazar MAŠ

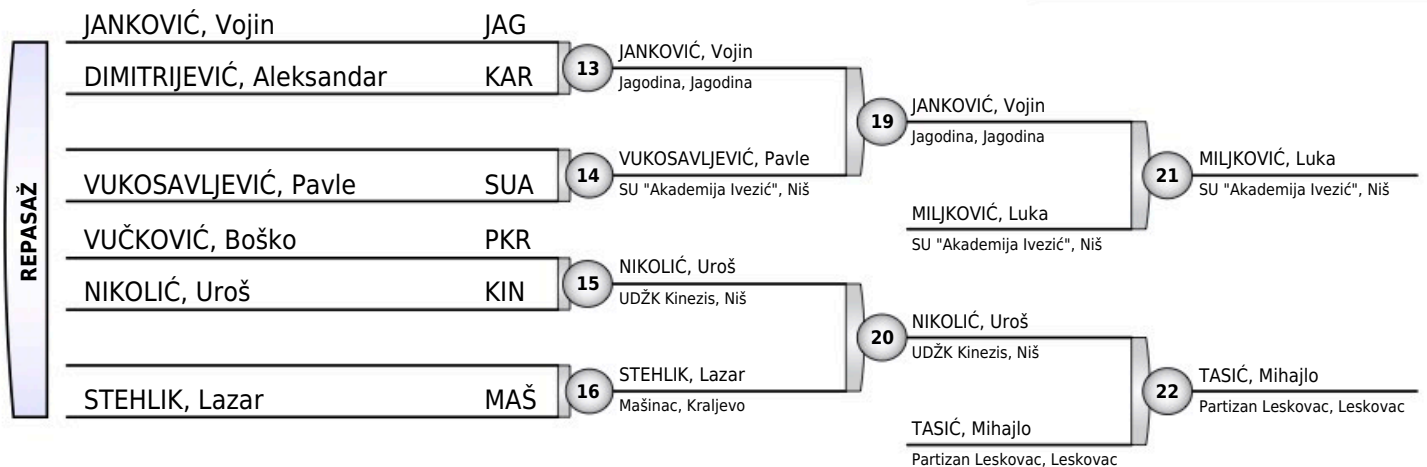



# REGIONALNO CS M.DEČACI

Aleksandrovac, 04.04.2026.

Mlađi dečaci  
**-34KG**  
14 takmičara

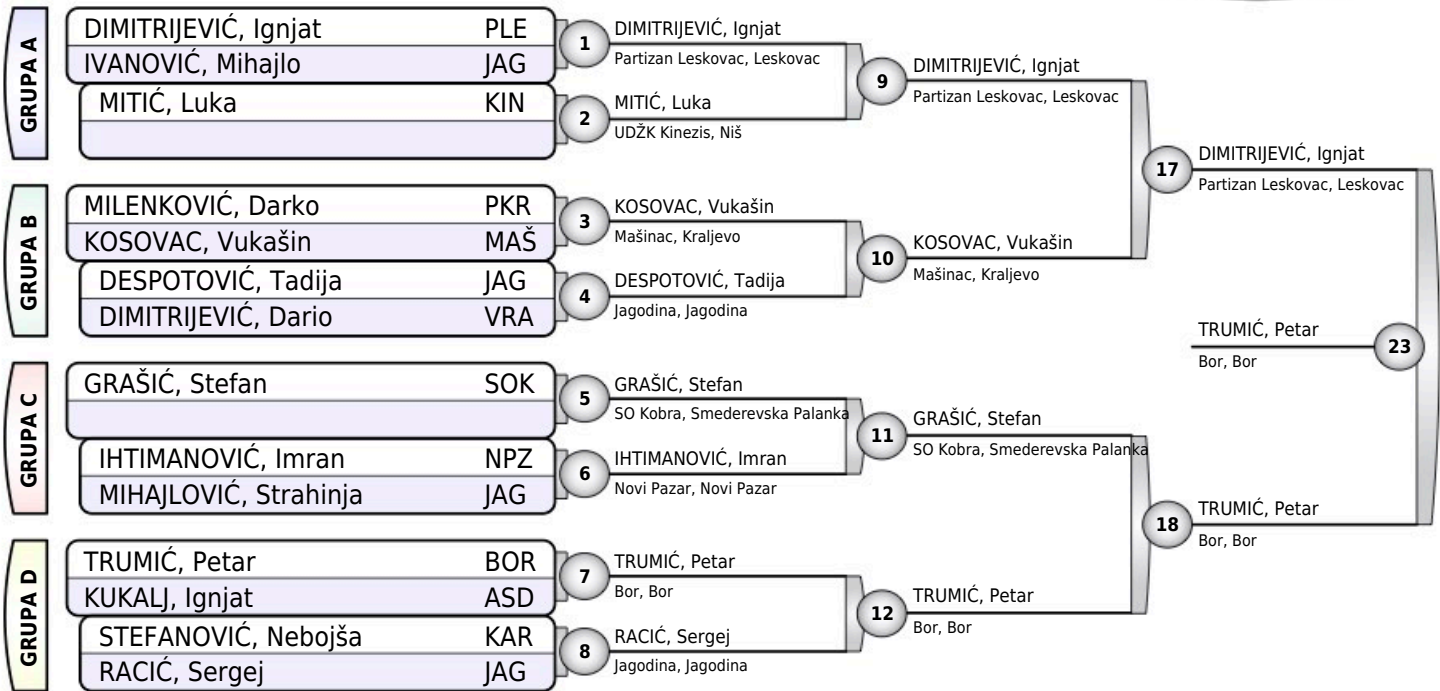

## Rezultati

1. TRUMIĆ, Petar BOR
2. DIMITRIJEVIĆ, Ignjat PLE
3. MITIĆ, Luka KIN
3. KOSOVAC, Vukašin MAŠ
5. GRAŠIĆ, Stefan SOK
5. IHTIMANOVIĆ, Imran NPZ
7. DESPOTOVIĆ, Tadija JAG
7. KUKALJ, Ignjat ASD

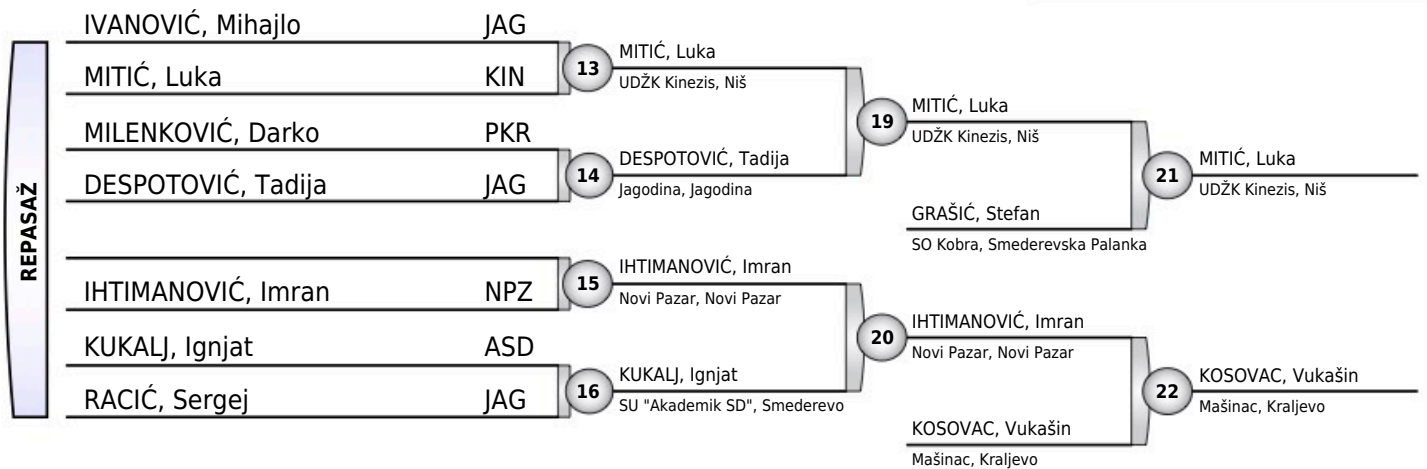



# REGIONALNO CS M.DEČACI

Aleksandrovac, 04.04.2026.

Mlađi dečaci  
**-38KG**  
25 takmičara

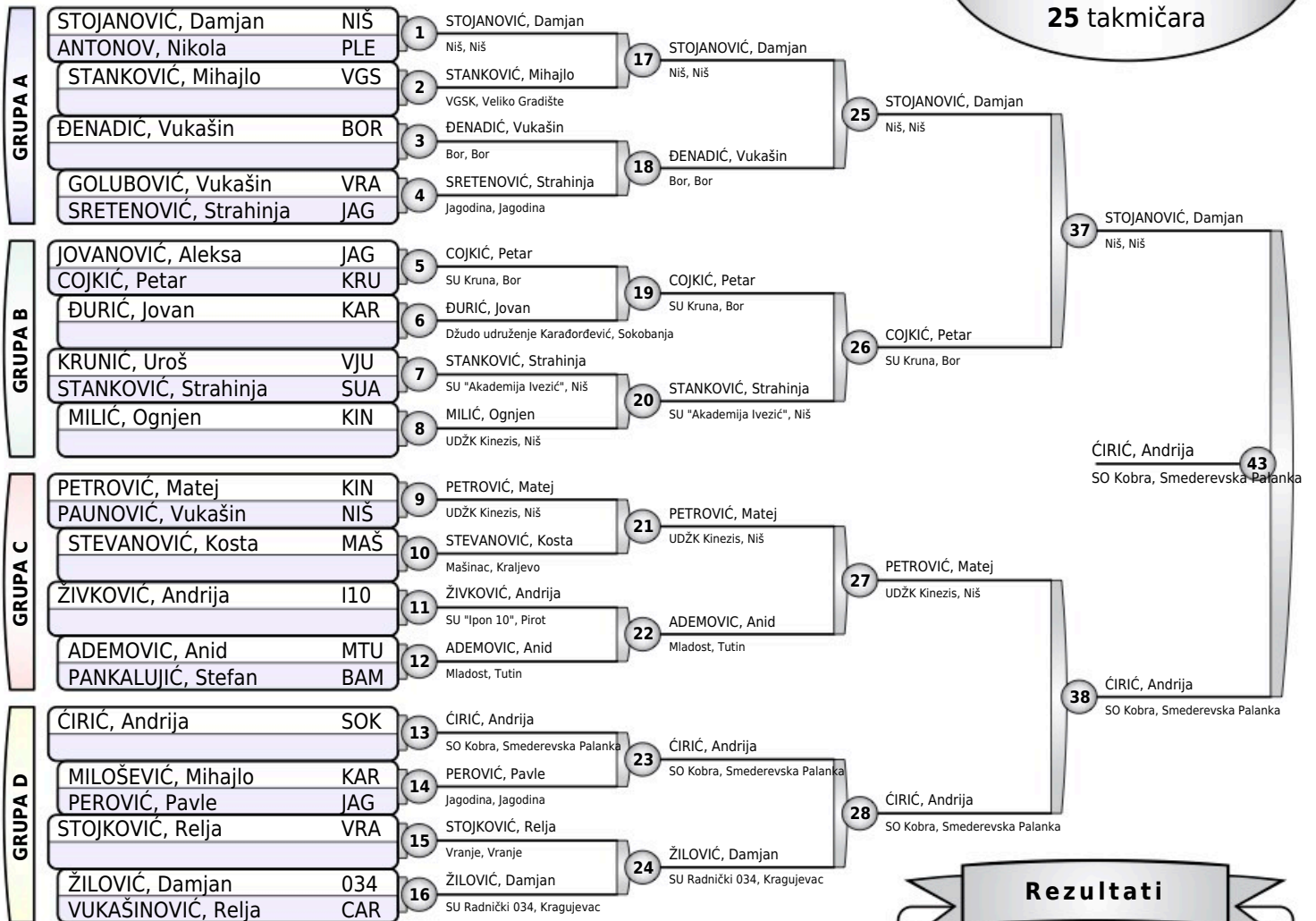

### Rezultati

1. ĆIRIĆ, Andrija	SOK
2. STOJANOVIĆ, Damjan	NIŠ
3. ĐENADIĆ, Vukašin	BOR
3. COJKIĆ, Petar	KRU
5. PETROVIĆ, Matej	KIN
5. ADEMOVIĆ, Anid	MTU
7. STANKOVIĆ, Strahinja	SUA
7. PEROVIĆ, Pavle	JAG

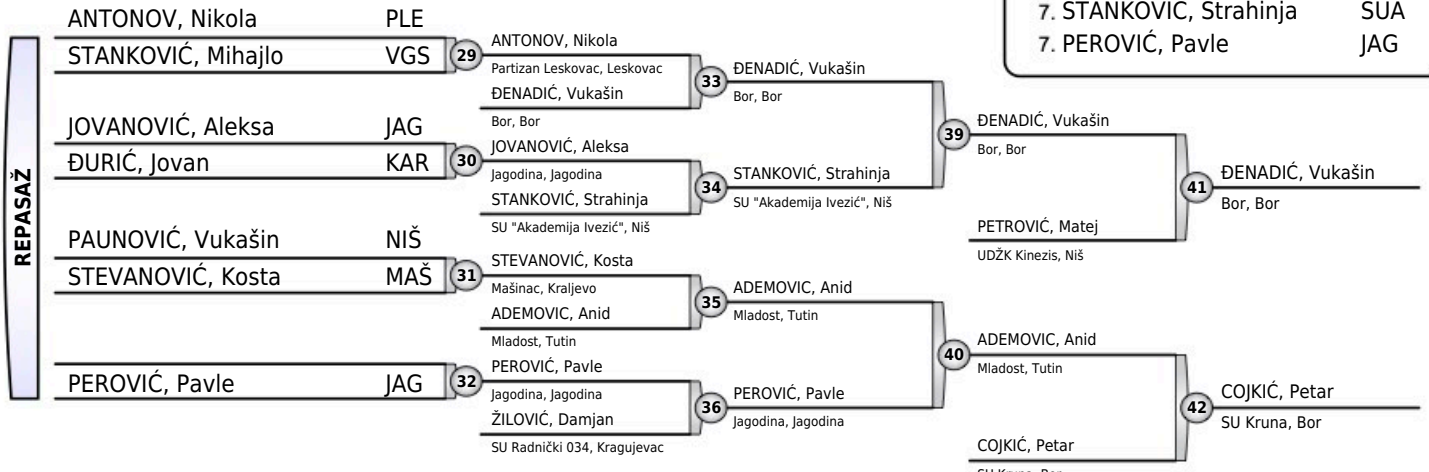



# REGIONALNO CS M.DEČACI

Aleksandrovac, 04.04.2026.

Mlađi dečaci

# -42KG

16 takmičara

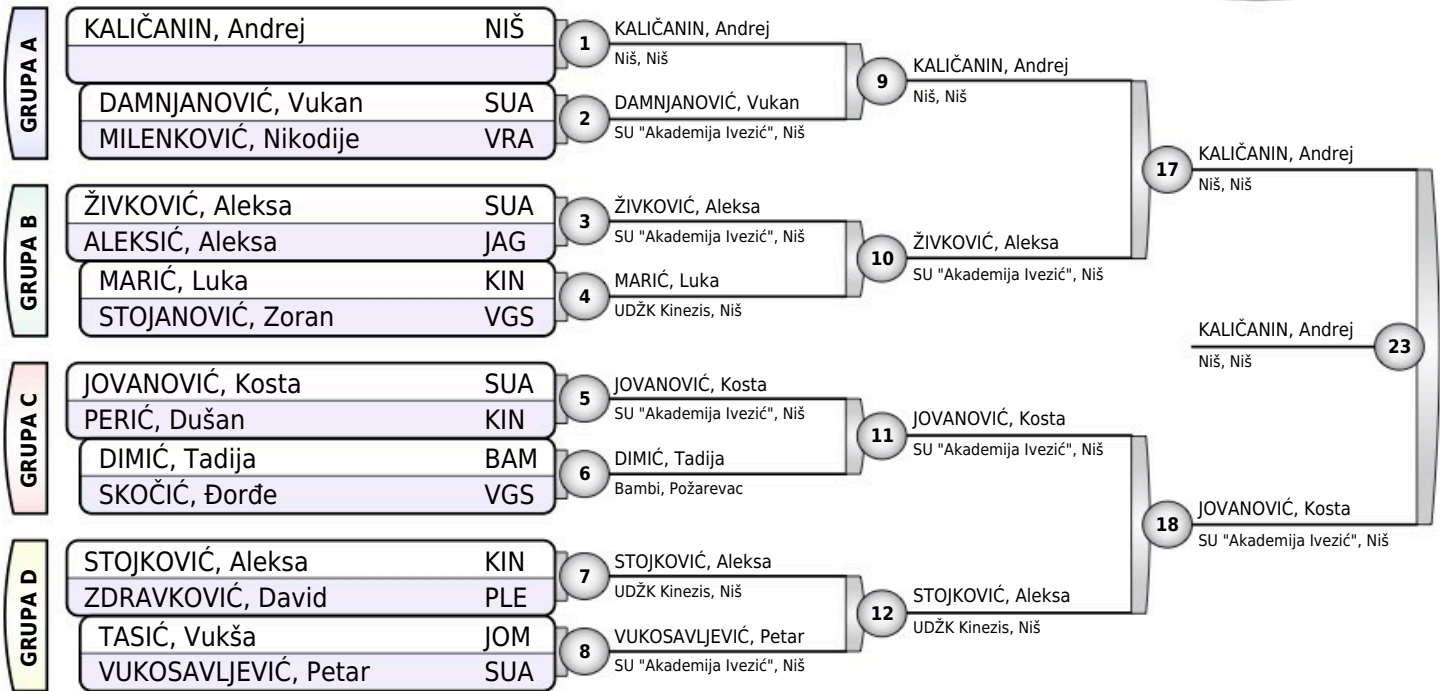

## Rezultati

1. KALIČANIN, Andrej NIŠ
2. JOVANOVIĆ, Kosta SUA
3. STOJKOVIĆ, Aleksa KIN
3. ŽIVKOVIĆ, Aleksa SUA
5. DAMNJANOVIĆ, Vukan SUA
5. DIMIĆ, Tadija BAM
7. MARIĆ, Luka KIN
7. ZDRAVKOVIĆ, David PLE

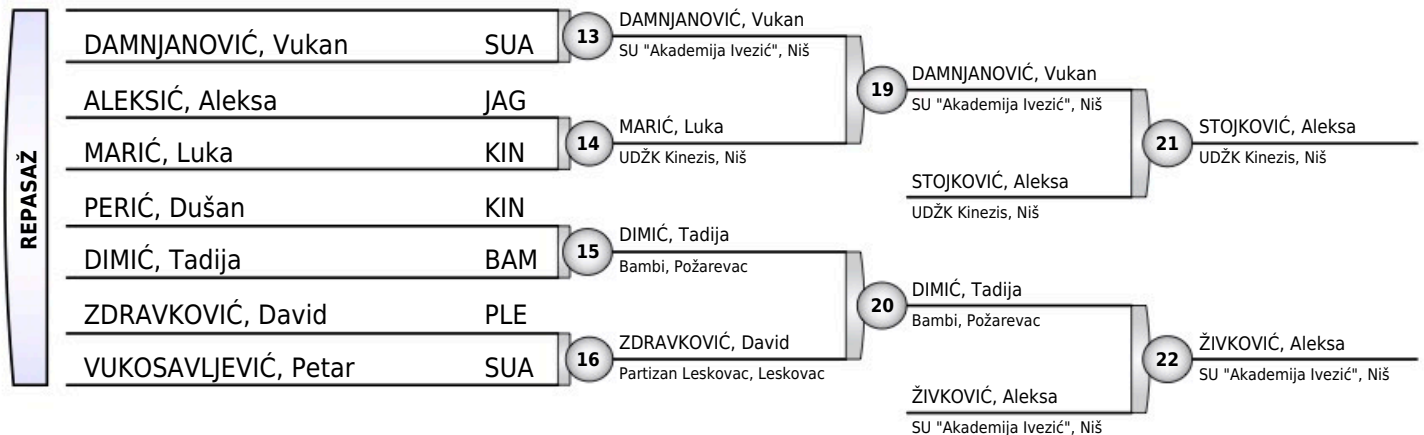



# REGIONALNO CS M.DEČACI

Aleksandrovac, 04.04.2026.

Mlađi dečaci

# -46KG

10 takmičara

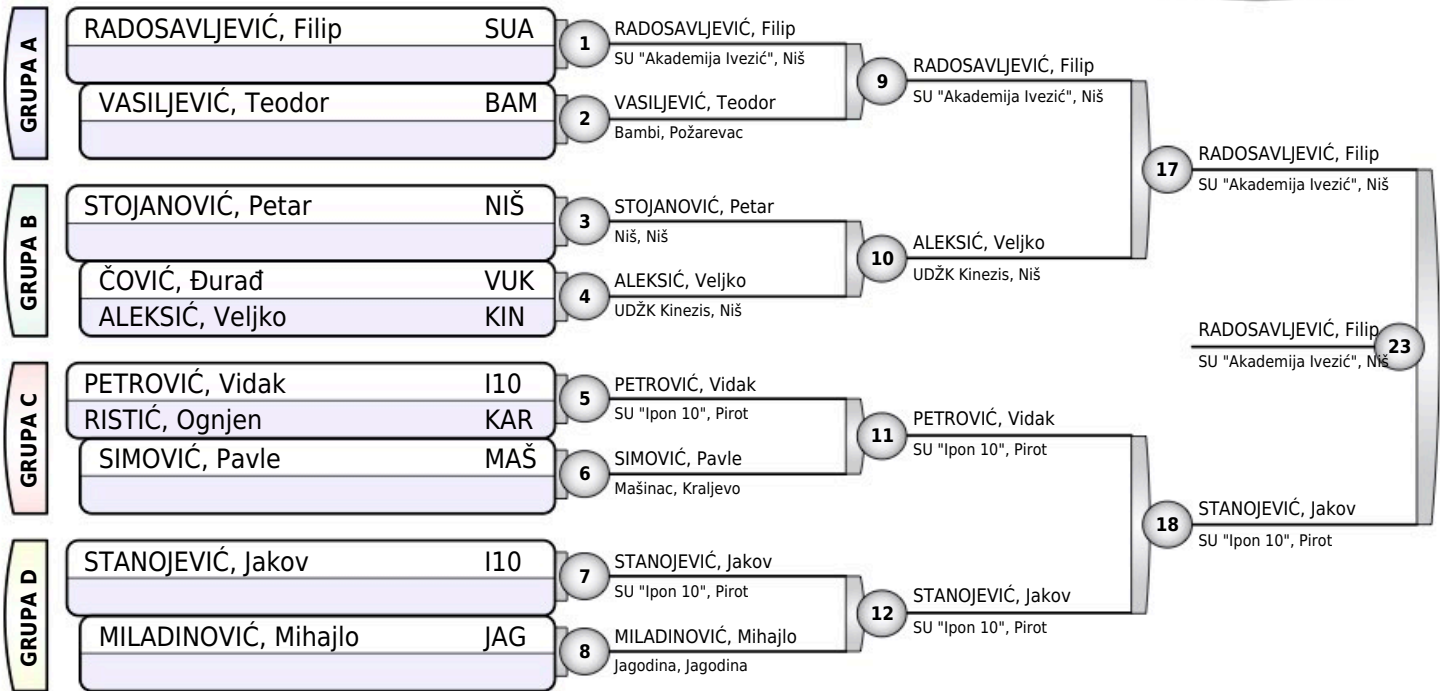

## Rezultati

1. RADOSAVLJEVIĆ, Filip (SUA)
2. STANOJEVIĆ, Jakov (I10)
3. STOJANOVIĆ, Petar (NIŠ)
3. ALEKSIĆ, Veljko (KIN)
5. PETROVIĆ, Vidak (I10)
5. MILADINOVIĆ, Mihajlo (JAG)
7. VASILJEVIĆ, Teodor (BAM)
7. RISTIĆ, Ognjen (KAR)

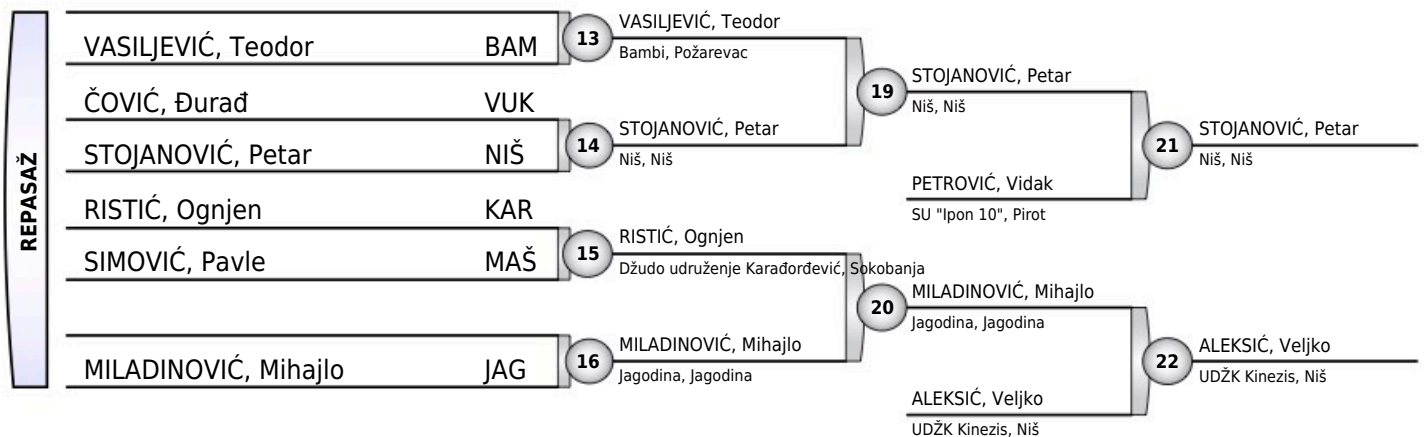



# REGIONALNO CS M.DEČACI

Aleksandrovac, 04.04.2026.

Mlađi dečaci  
**-50KG**  
14 takmičara

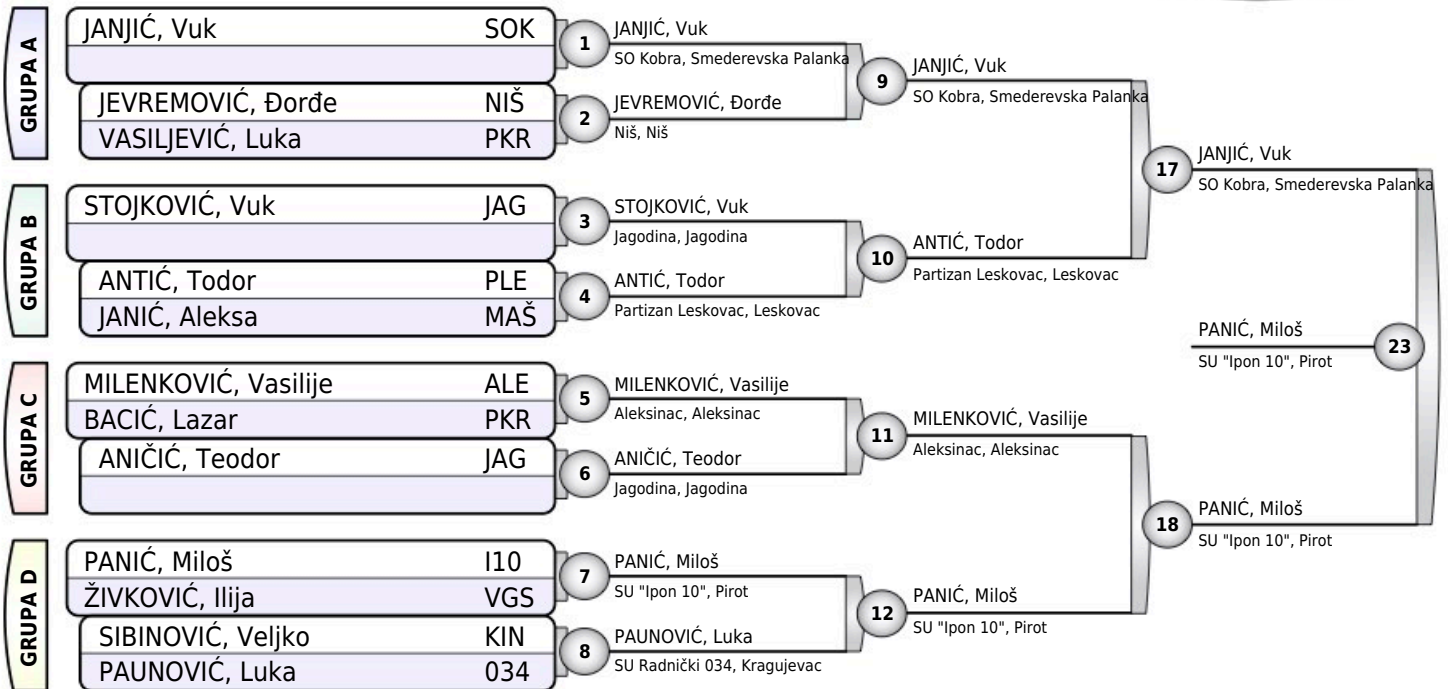

## Rezultati

- PANIĆ, Miloš I10
- JANJIĆ, Vuk SOK
- MILENKOVIĆ, Vasilije ALE
- ANTIĆ, Todor PLE
- JEVREMOVIĆ, Đorđe NIŠ
- ANIČIĆ, Teodor JAG
- STOJKOVIĆ, Vuk JAG
- PAUNOVIĆ, Luka 034

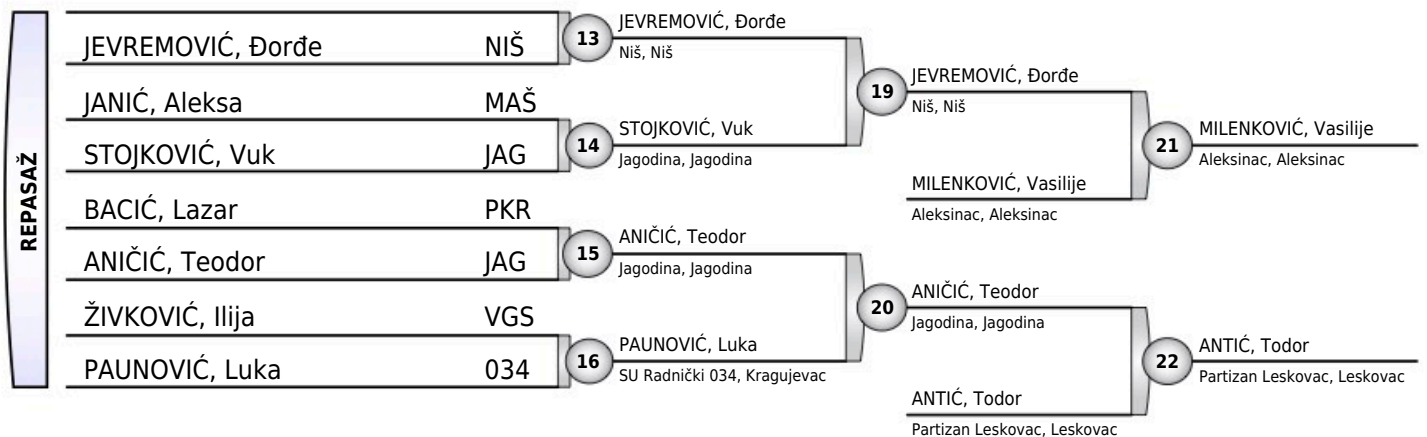



# REGIONALNO CS M.DEČACI

Aleksandrovac, 04.04.2026.

Mlađi dečaci

## -55KG

9 takmičara

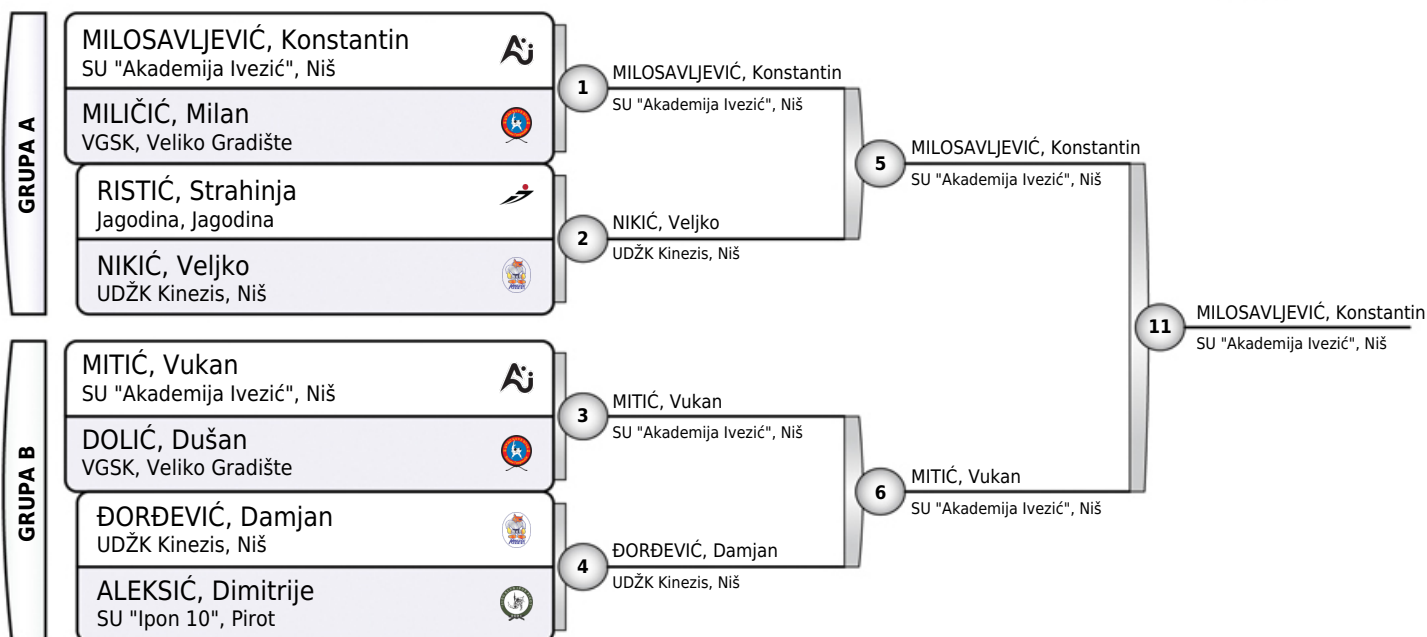

### Rezultati

1. MILOSAVLJEVIĆ, Konstantin SUA
2. MITIĆ, Vukan SUA
3. ĐORĐEVIĆ, Damjan KIN
3. NIKIĆ, Veljko KIN
5. RISTIĆ, Strahinja JAG
5. ALEKSIĆ, Dimitrije I10
7. MILIČIĆ, Milan VGS
7. DOLIĆ, Dušan VGS

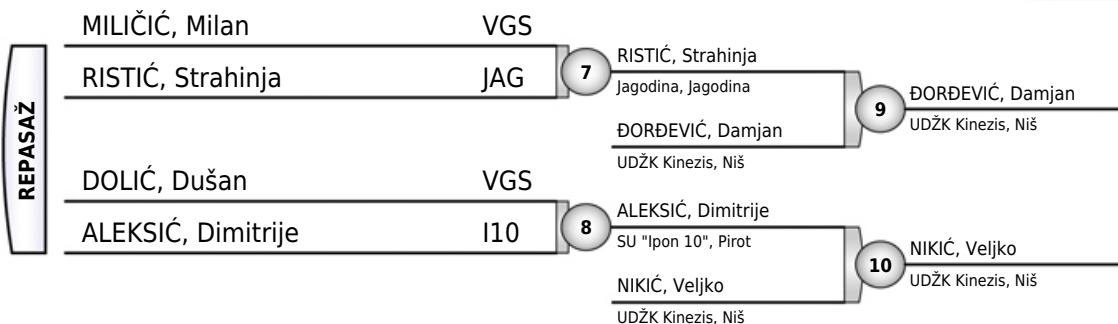



# REGIONALNO CS M.DEČACI

Aleksandrovac, 04.04.2026.

Mlađi dečaci

# -60KG

9 takmičara

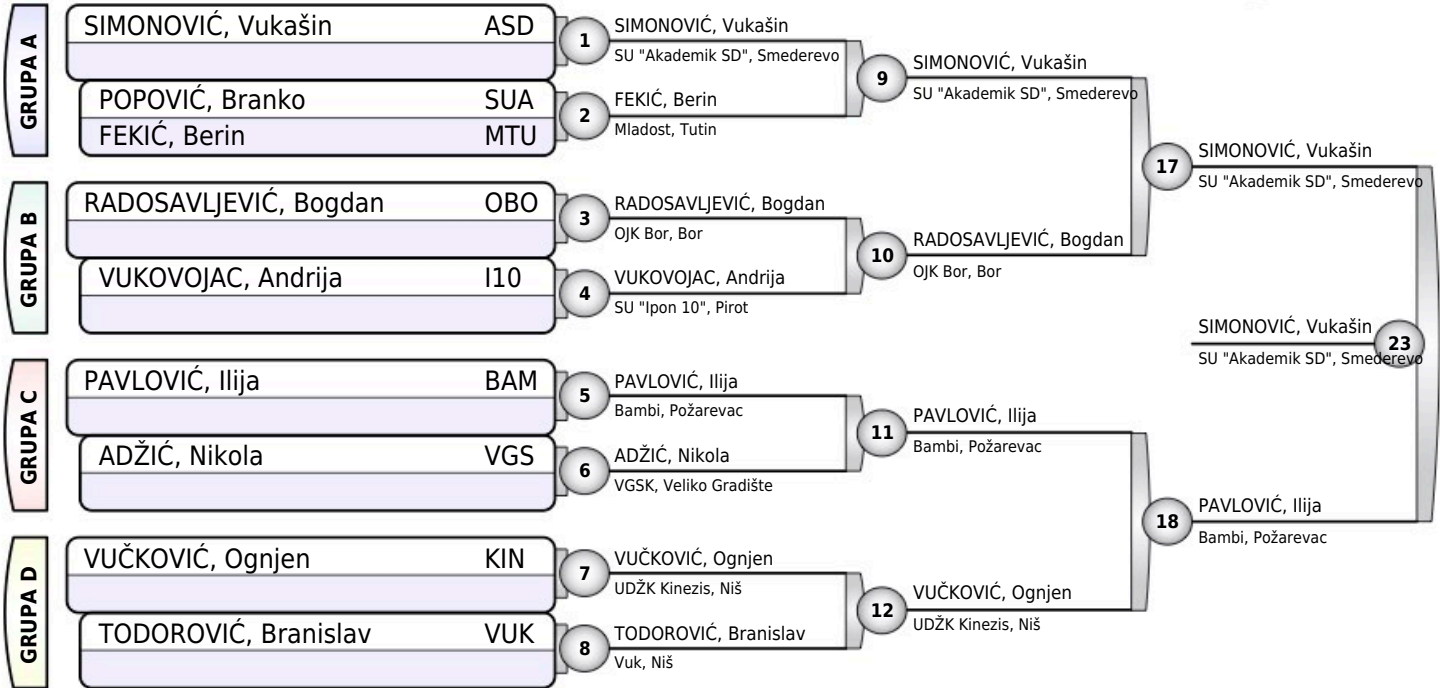

## Rezultati

1. SIMONOVIĆ, Vukašin ASD
2. PAVLOVIĆ, Ilija BAM
3. FEKIĆ, Berin MTU
3. ADŽIĆ, Nikola VGS
5. VUČKOVIĆ, Ognjen KIN
5. RADOSAVLJEVIĆ, Bogdan OBO
7. VUKOVOJAC, Andrija I10
7. TODOROVIĆ, Branislav VUK

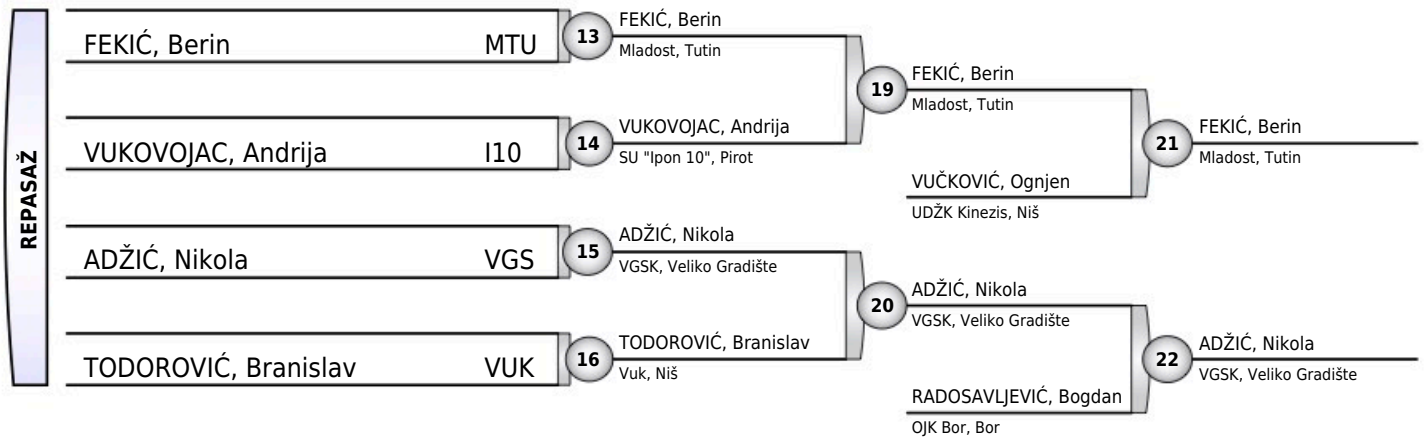



# REGIONALNO CS M.DEČACI

Aleksandrovac, 04.04.2026.

Mlađi dečaci  
**-66KG**  
13 takmičara

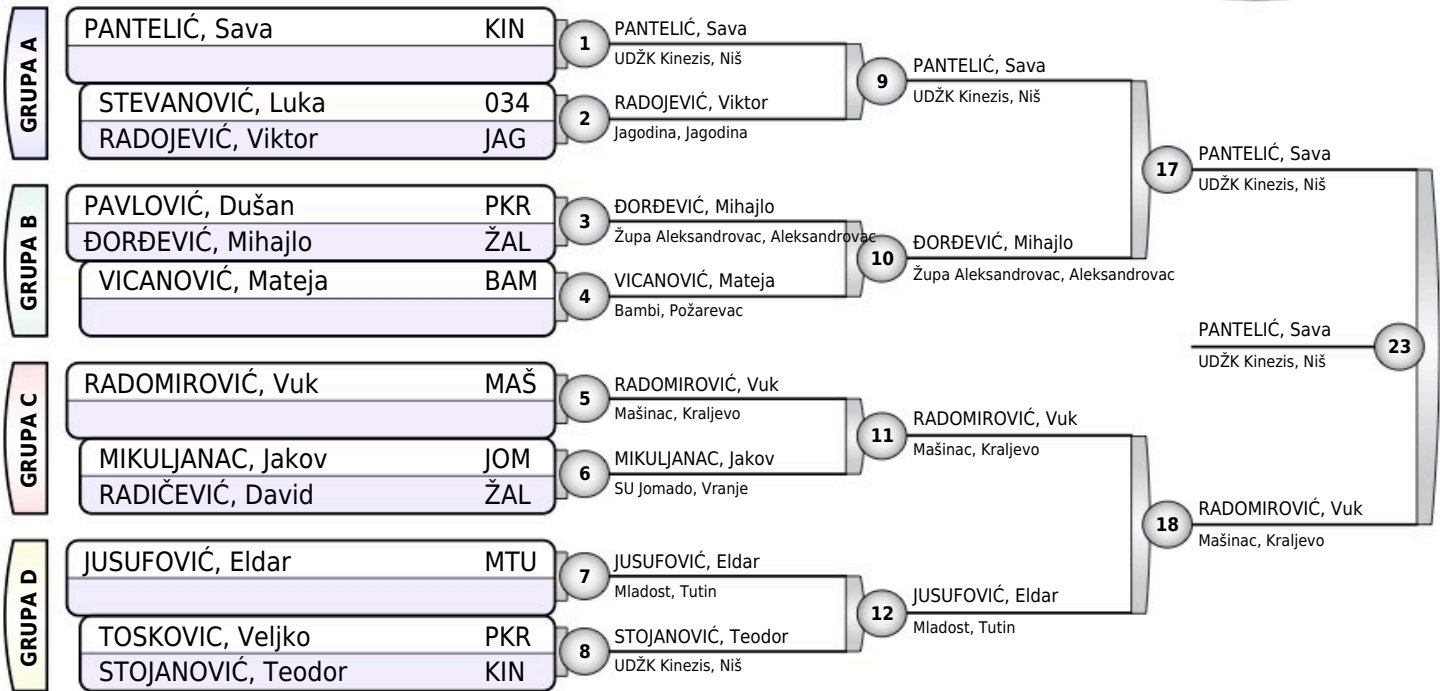

## Rezultati

1. PANTELIĆ, Sava KIN
2. RADOMIROVIĆ, Vuk MAŠ
3. JUSUFOVIĆ, Eldar MTU
3. ĐORĐEVIĆ, Mihajlo ŽAL
5. VICANOVIĆ, Mateja BAM
5. MIKULJANAC, Jakov JOM
7. RADOJEVIĆ, Viktor JAG
7. STOJANOVIĆ, Teodor KIN

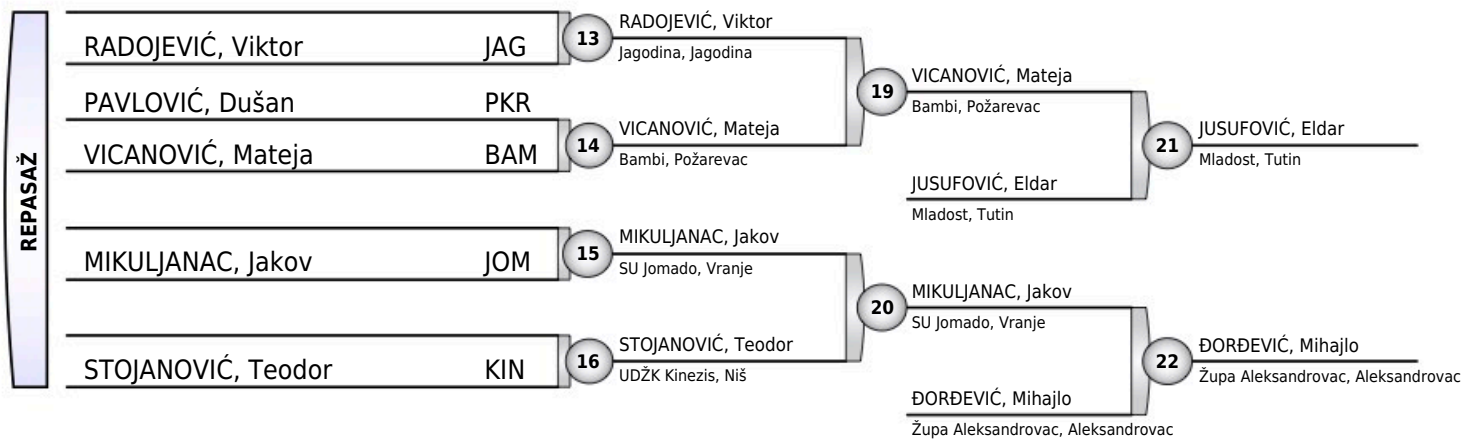



# REGIONALNO CS M.DEČACI

Aleksandrovac, 04.04.2026.

Mlađi dečaci

# +66KG

6 takmičara

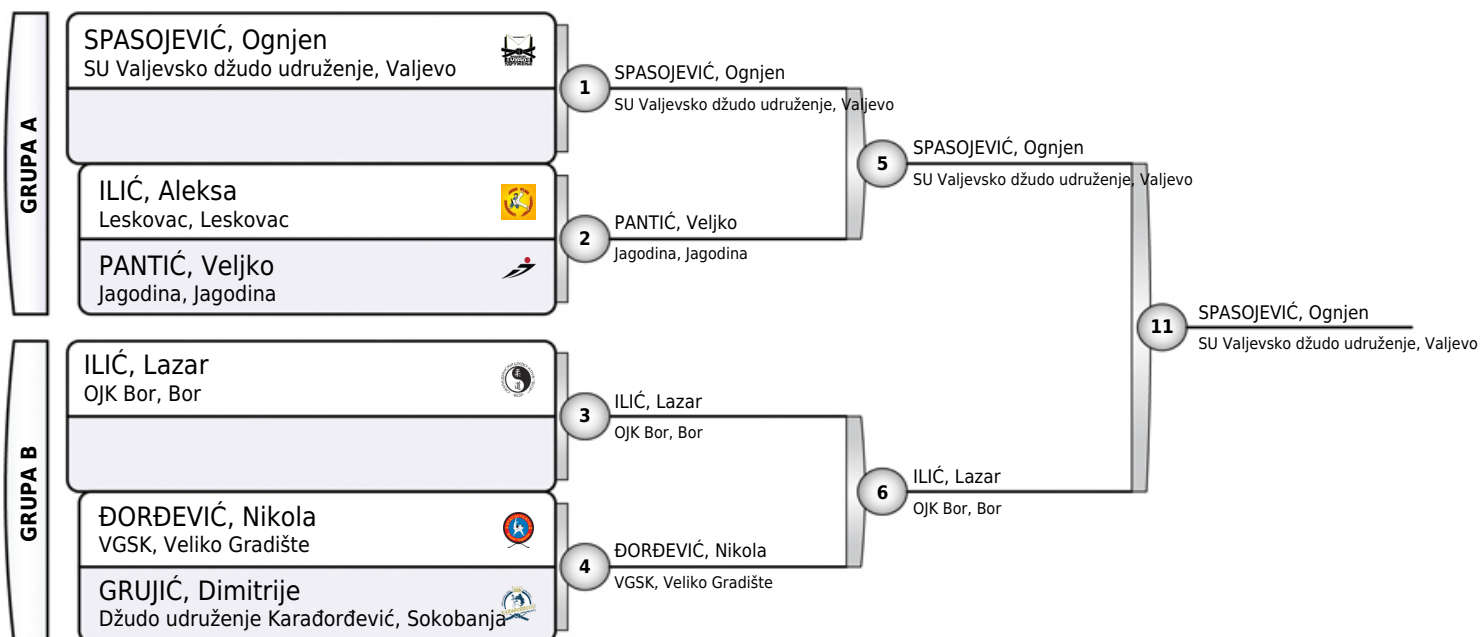

## Rezultati

- |    |                    |     |
|----|--------------------|-----|
| 1. | SPASOJEVIĆ, Ognjen | VJU |
| 2. | ILIĆ, Lazar        | OBO |
| 3. | ĐORĐEVIĆ, Nikola   | VGS |
| 3. | PANTIĆ, Veljko     | JAG |
| 5. | ILIĆ, Aleksa       | LES |
| 5. | GRUJIĆ, Dimitrije  | KAR |
| 7. |                    |     |
| 7. |                    |     |

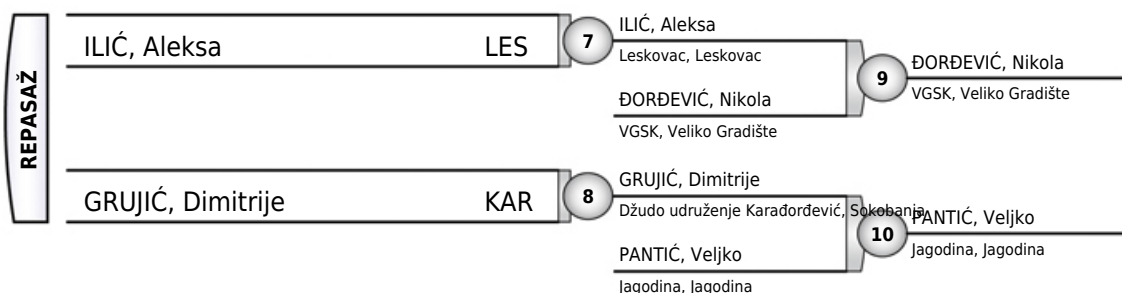



# REGIONALNO CS M.DEČACI

Aleksandrovac, 04.04.2026.

Mlađe devojčice

# -32KG

12 takmičarki

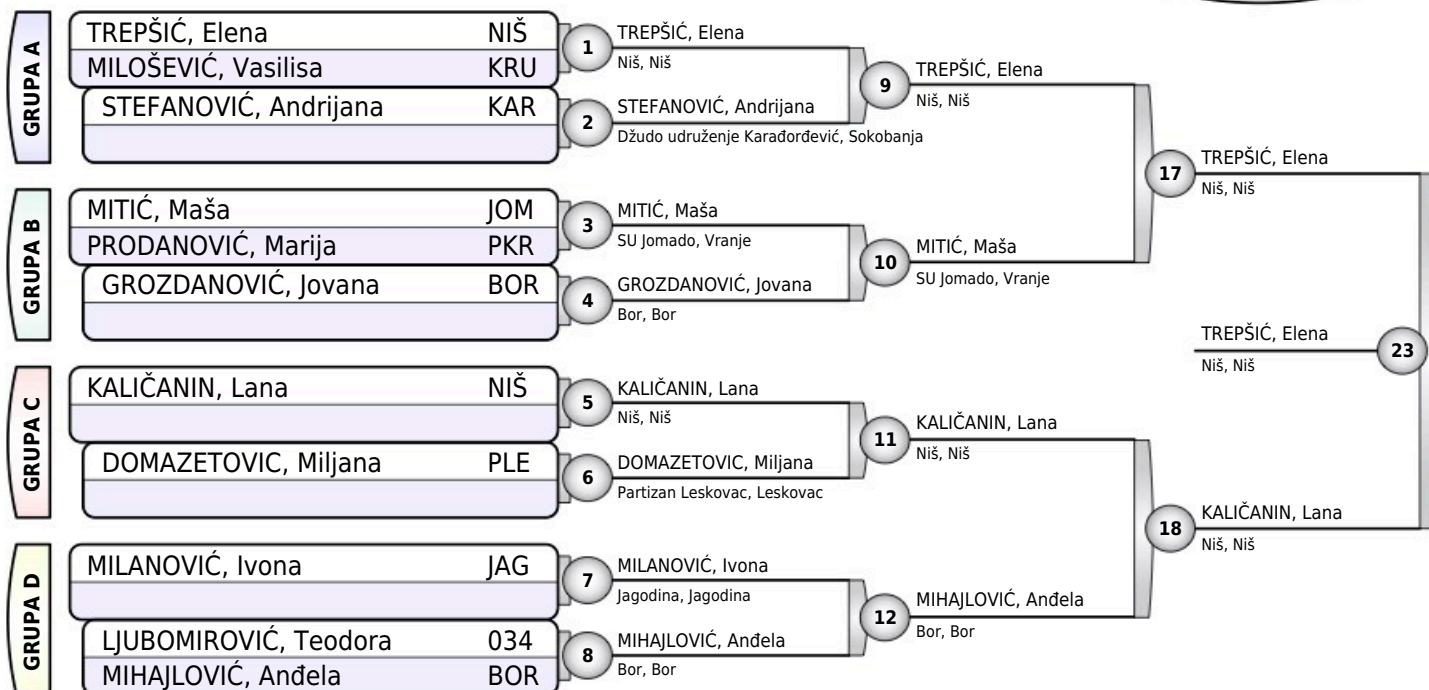

## Rezultati

1. TREPŠIĆ, Elena NIŠ
2. KALIČANIN, Lana NIŠ
3. MILOŠEVIĆ, Vasilisa KRU
3. MITIĆ, Maša JOM
5. MIHAJLOVIĆ, Anđela BOR
5. DOMAZETOVIC, Miljana PLE
7. GROZDANOVIĆ, Jovana BOR
7. MILANOVIĆ, Ivona JAG

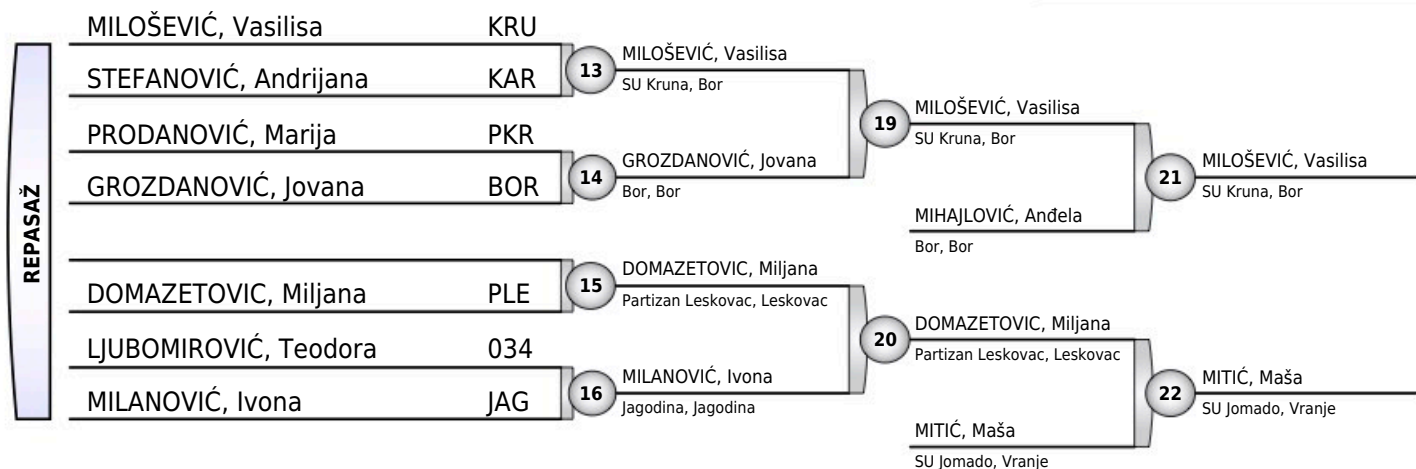



# REGIONALNO CS M.DEČACI

Aleksandrovac, 04.04.2026.

Mlađe devojčice

# -36KG

10 takmičarki

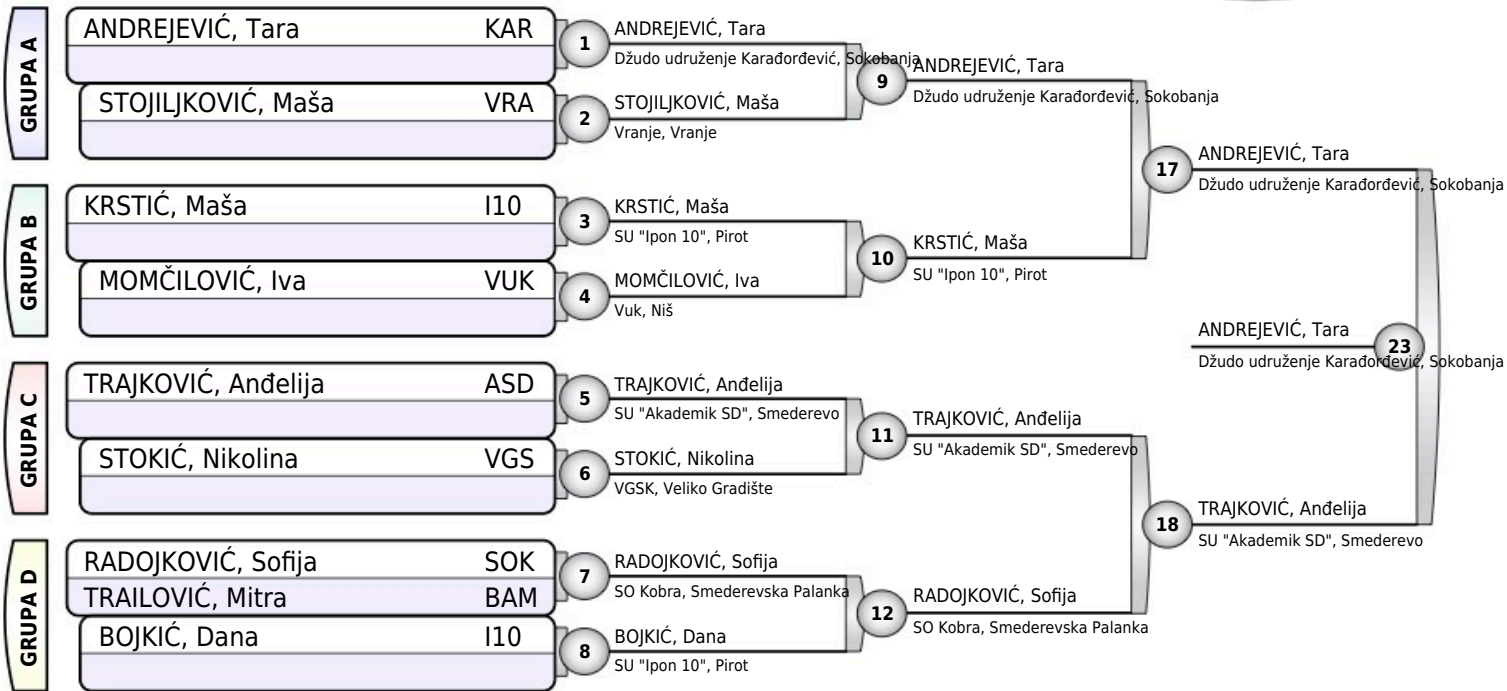

## Rezultati

1. ANDREJEVIĆ, Tara (KAR)
2. TRAJKOVIĆ, Anđelija (ASD)
3. RADOJKOVIĆ, Sofija (SOK)
3. KRSTIĆ, Maša (I10)
5. STOJILJKOVIĆ, Maša (VRA)
5. STOKIĆ, Nikolina (VGS)
7. MOMČILOVIĆ, Iva (VUK)
7. BOJKIĆ, Dana (I10)

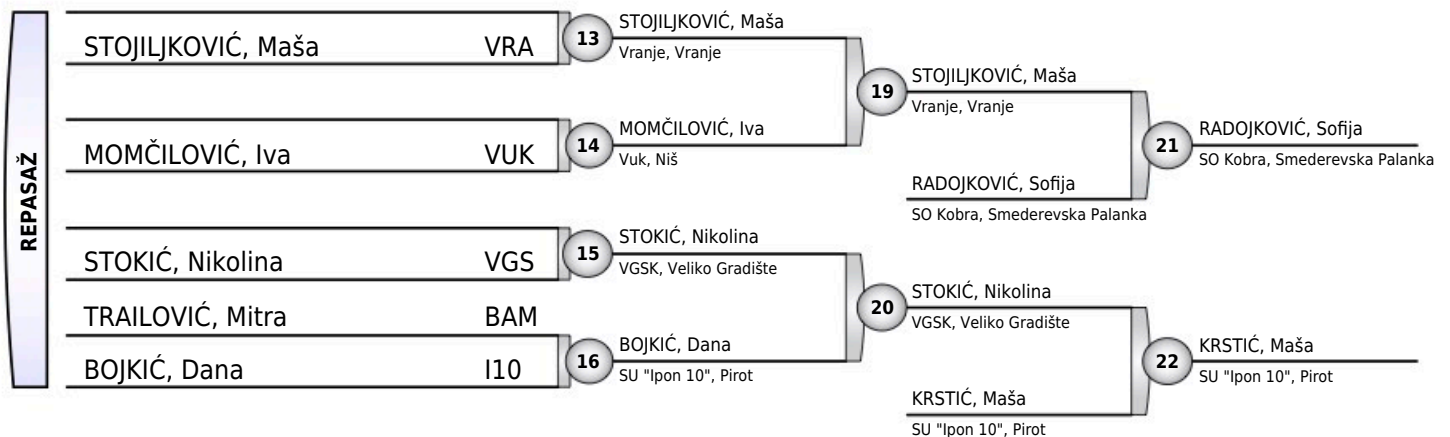



# REGIONALNO CS M.DEČACI

Aleksandrovac, 04.04.2026.

Mlađe devojčice

# -40KG

10 takmičarki

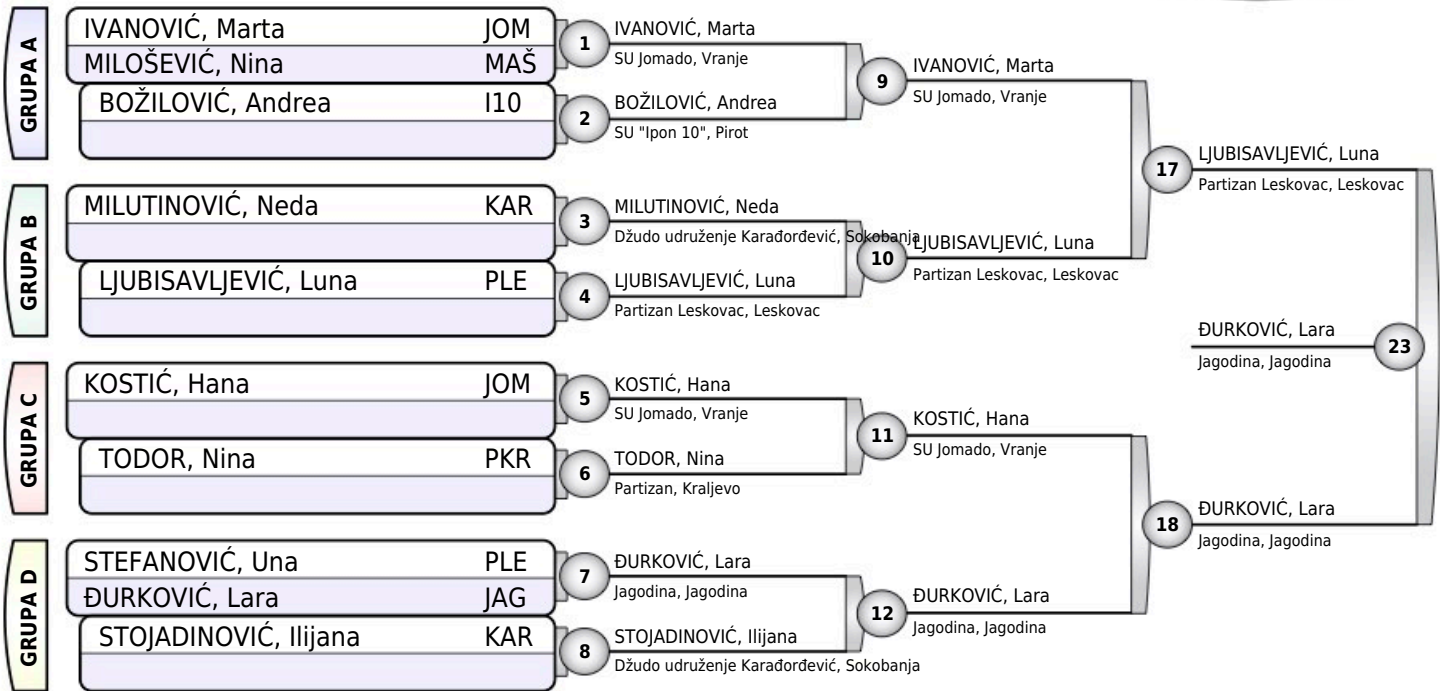

## Rezultati

- ĐURKOVIĆ, Lara (JAG)
- LJUBISAVLJEVIĆ, Luna (PLE)
- KOSTIĆ, Hana (JOM)
- IVANOVIĆ, Marta (JOM)
- MILOŠEVIĆ, Nina (MAŠ)
- STOJADINOVIĆ, Ilijana (KAR)
- MILUTINOVIĆ, Neda (KAR)
- TODOR, Nina (PKR)

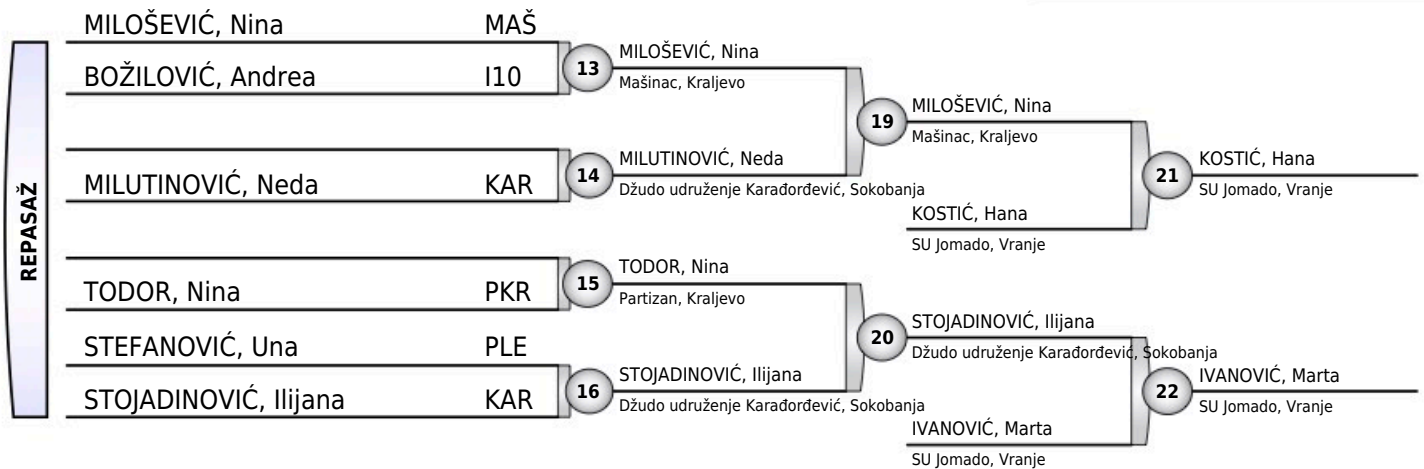



# REGIONALNO CS M.DEČACI

Aleksandrovac, 04.04.2026.

Mlađe devojčice

# -44KG

3 takmičarke

Takmičar i klub	1	2	3	Pobeda	Bodova	Mesto
1 STOJILJKOVIĆ, Magdalena Leskovac, Leskovac		0	0	0	0	3
2 ANTIĆ, Nikolina Partizan Leskovac, Leskovac	100		0	1	100	2
3 JEVREMOVIĆ, Julija Carina, Smederevo	100	10		2	110	1

STOJILJKOVIĆ, Magdalena	LES	1	ANTIĆ, Nikolina
ANTIĆ, Nikolina	PLE		Partizan Leskovac, Leskovac
STOJILJKOVIĆ, Magdalena	LES	2	JEVREMOVIĆ, Julija
JEVREMOVIĆ, Julija	CAR		Carina, Smederevo
ANTIĆ, Nikolina	PLE	3	JEVREMOVIĆ, Julija
JEVREMOVIĆ, Julija	CAR		Carina, Smederevo

## Rezultati

1. JEVREMOVIĆ, Julija CAR
2. ANTIĆ, Nikolina PLE
3. STOJILJKOVIĆ, Magdalena LES



# REGIONALNO CS M.DEČACI

Aleksandrovac, 04.04.2026.

Mlađe devojčice

# -48KG

4 takmičarke

Takmičar i klub	1	2	3	4	Pobeda	Bodova	Mesto
1 KANKARAŠ, Sofija VGSK, Veliko Gradište		0	0	0	0	0	3
2 ZLATKOVIĆ, Daša Partizan Leskovac, Leskovac	100		100	100	3	300	1
3 JOCOVIĆ, Nina SU Radnički 034, Kragujevac	10	0		100	2	110	2
4 ČOVIĆ, Katica Vuk, Niš	100	0	0		1	100	3

KANKARAŠ, Sofija	VGS	1	ZLATKOVIĆ, Daša
ZLATKOVIĆ, Daša	PLE		Partizan Leskovac, Leskovac
JOCOVIC, Nina	034	2	JOCOVIC, Nina
ČOVIĆ, Katica	VUK		SU Radnički 034, Kragujevac
KANKARAŠ, Sofija	VGS	3	JOCOVIC, Nina
JOCOVIC, Nina	034		SU Radnički 034, Kragujevac
ZLATKOVIĆ, Daša	PLE	4	ZLATKOVIĆ, Daša
ČOVIĆ, Katica	VUK		Partizan Leskovac, Leskovac
KANKARAŠ, Sofija	VGS	5	ČOVIĆ, Katica
ČOVIĆ, Katica	VUK		Vuk, Niš
ZLATKOVIĆ, Daša	PLE	6	ZLATKOVIĆ, Daša
JOCOVIC, Nina	034		Partizan Leskovac, Leskovac

## Rezultati

1. ZLATKOVIĆ, Daša PLE
2. JOCOVIĆ, Nina 034
3. ČOVIĆ, Katica VUK
3. KANKARAŠ, Sofija VGS



# REGIONALNO CS M.DEČACI

Aleksandrovac, 04.04.2026.

Mlađe devojčice

# -52KG

4 takmičarke

Takmičar i klub	1	2	3	4	Pobeda	Bodova	Mesto
1 SAVIĆ, Jovana Vuk, Niš		0	100	100	2	200	2
2 MATOVIĆ, Marija Mašinac, Kraljevo	100		100	100	3	300	1
3 MINIĆ, Luna SU "Ipon 10", Pirot	0	0		1	1	1	3
4 PETKOVIĆ, Marija Džudo udruženje Karadorđević, Sokobanja	0	0	0		0	0	3

SAVIĆ, Jovana	VUK	1	MATOVIĆ, Marija
MATOVIĆ, Marija	MAŠ		Mašinac, Kraljevo
MINIĆ, Luna	I10	2	MINIĆ, Luna
PETKOVIĆ, Marija	KAR		SU "Ipon 10", Pirot
SAVIĆ, Jovana	VUK	3	SAVIĆ, Jovana
MINIĆ, Luna	I10		Vuk, Niš
MATOVIĆ, Marija	MAŠ	4	MATOVIĆ, Marija
PETKOVIĆ, Marija	KAR		Mašinac, Kraljevo
SAVIĆ, Jovana	VUK	5	SAVIĆ, Jovana
PETKOVIĆ, Marija	KAR		Vuk, Niš
MATOVIĆ, Marija	MAŠ	6	MATOVIĆ, Marija
MINIĆ, Luna	I10		Mašinac, Kraljevo

## Rezultati

1. MATOVIĆ, Marija MAŠ
2. SAVIĆ, Jovana VUK
3. MINIĆ, Luna I10
3. PETKOVIĆ, Marija KAR



# REGIONALNO CS M.DEČACI

Aleksandrovac, 04.04.2026.

Mlađe devojčice

## -56KG

6 takmičarki

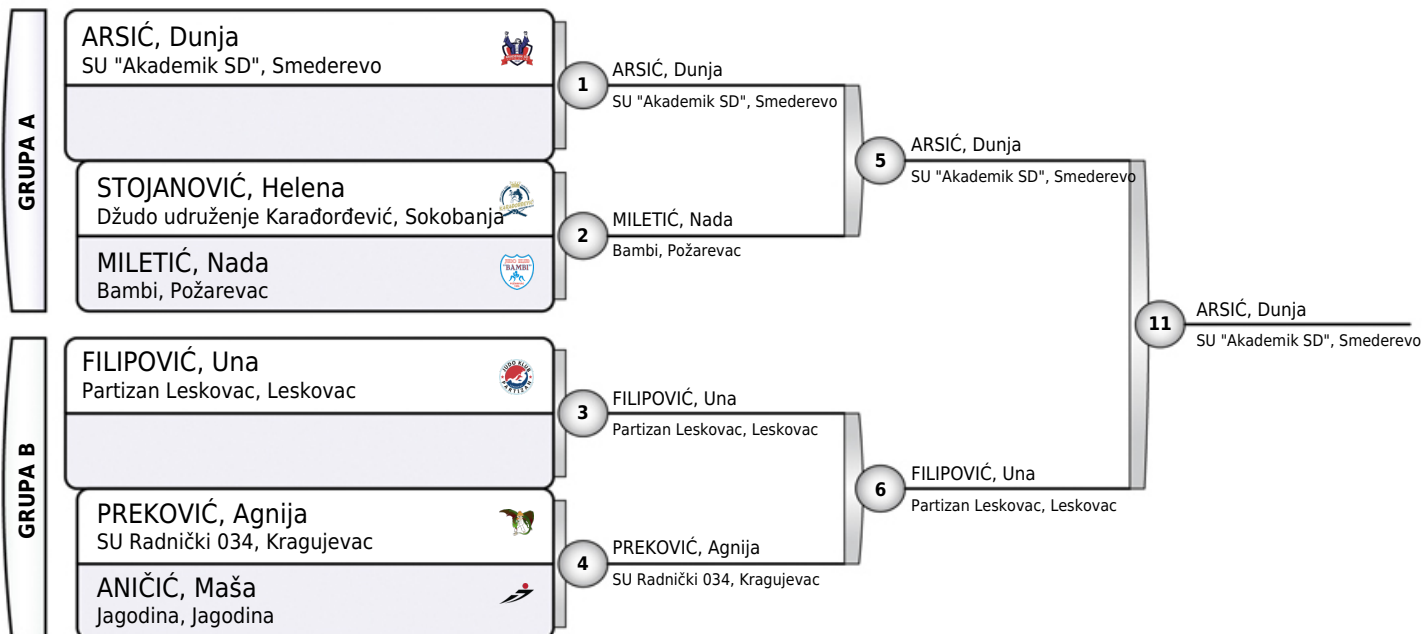

### Rezultati

1. ARSIĆ, Dunja ASD
2. FILIPOVIĆ, Una PLE
3. PREKOVIĆ, Agnija 034
3. MILETIĆ, Nada BAM
5. STOJANOVIĆ, Helena KAR
5. ANIČIĆ, Maša JAG
- 7.
- 7.





# REGIONALNO CS M.DEČACI

Aleksandrovac, 04.04.2026.

Mlađe devojčice

# +56KG

8 takmičarki

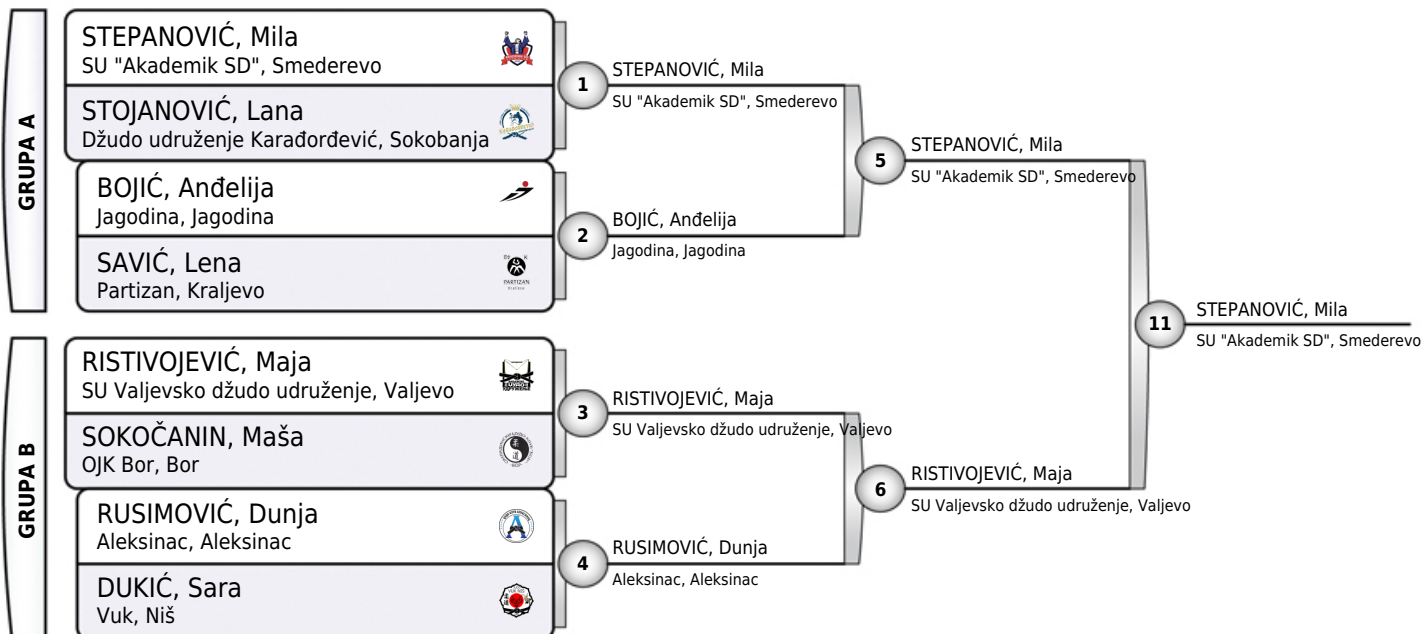

## Rezultati

- |    |                    |     |
|----|--------------------|-----|
| 1. | STEPANOVIĆ, Mila   | ASD |
| 2. | RISTIVOJEVIĆ, Maja | VJU |
| 3. | RUSIMOVIĆ, Dunja   | ALE |
| 3. | BOJIĆ, Anđelija    | JAG |
| 5. | STOJANOVIĆ, Lana   | KAR |
| 5. | SOKOČANIN, Maša    | OBO |
| 7. | SAVIĆ, Lena        | PKR |
| 7. | DUKIĆ, Sara        | VUK |

