

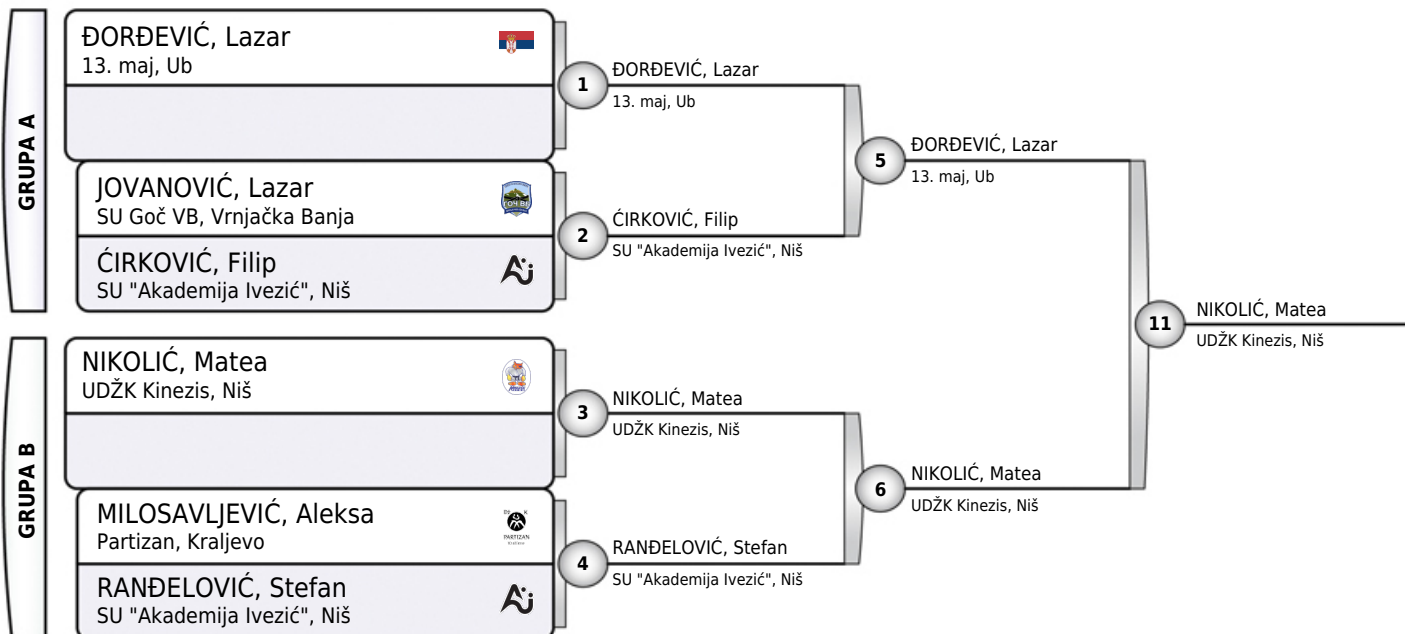

REGIONALNO CS JUNIORI

Požarevac, 19.04.2026.

Juniori
-60KG
6 takmičara



Rezultati

1. NIKOLIĆ, Matea KIN
2. ĐORĐEVIĆ, Lazar 13U
3. RANĐELOVIĆ, Stefan SUA
3. ĆIRKOVIĆ, Filip SUA
5. JOVANOVIĆ, Lazar GVB
5. MILOSAVLJEVIĆ, Aleksa PKR
- 7.
- 7.

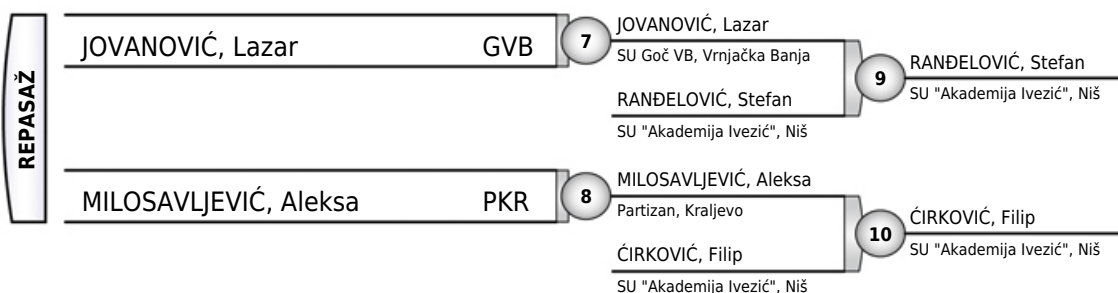



REGIONALNO CS JUNIORI

Požarevac, 19.04.2026.

Juniori
-66KG
8 takmičara

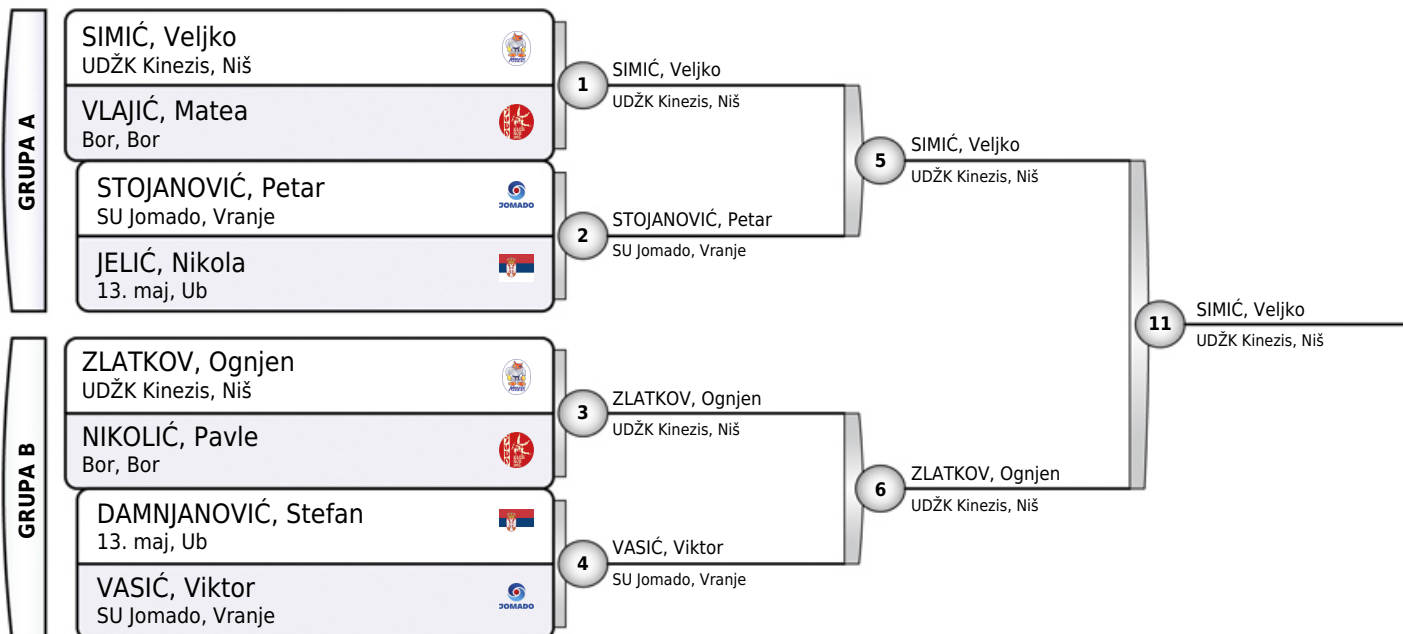

Rezultati

- | | |
|------------------------|-----|
| 1. SIMIĆ, Veljko | KIN |
| 2. ZLATKOV, Ognjen | KIN |
| 3. VLAJIĆ, Matea | BOR |
| 3. NIKOLIĆ, Pavle | BOR |
| 5. VASIĆ, Viktor | JOM |
| 5. STOJANOVIĆ, Petar | JOM |
| 7. JELIĆ, Nikola | 13U |
| 7. DAMNJANOVIĆ, Stefan | 13U |

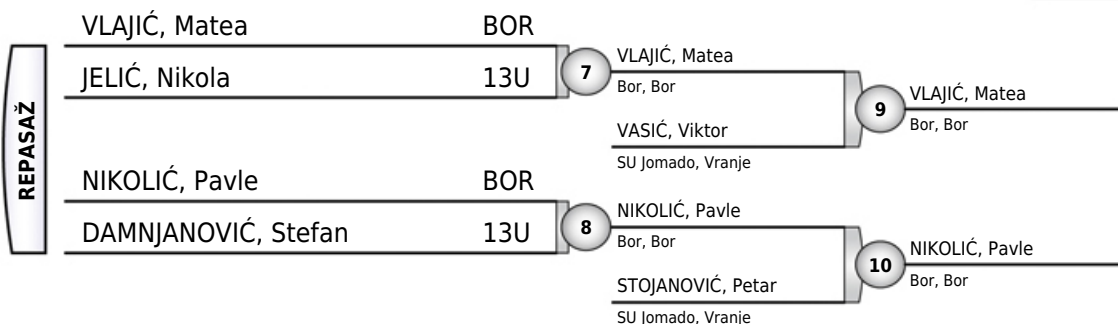



REGIONALNO CS JUNIORI

Požarevac, 19.04.2026.

Juniori
-73KG
19 takmičara

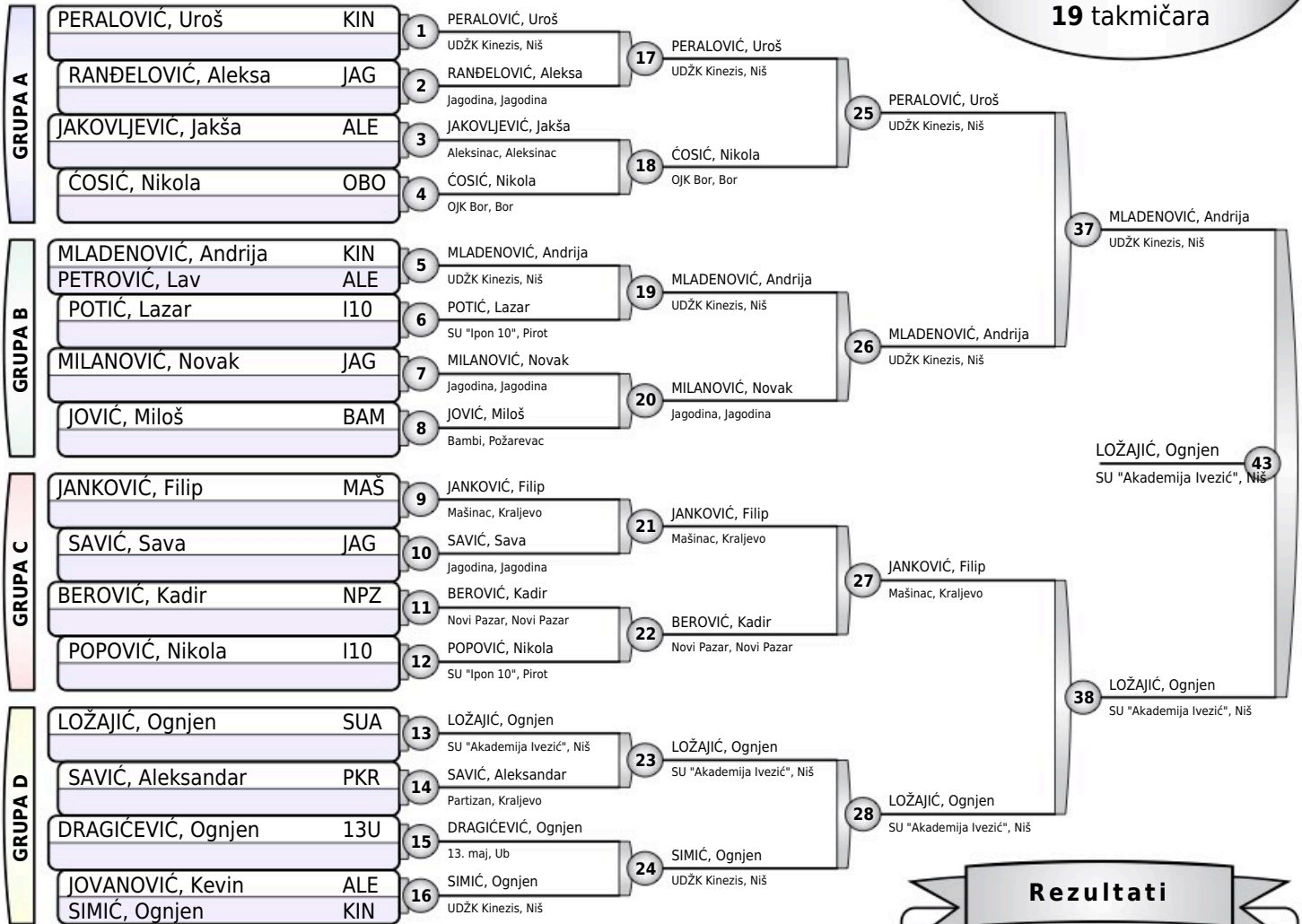

Rezultati

1. LOŽAJIĆ, Ognjen SUA
2. MLADENOVIĆ, Andrija KIN
3. MILANOVIĆ, Novak JAG
3. PERALOVIĆ, Uroš KIN
5. JANKOVIĆ, Filip MAŠ
5. BEROVIĆ, Kadir NPZ
7. RANĐELOVIĆ, Aleksa JAG
7. SIMIĆ, Ognjen KIN

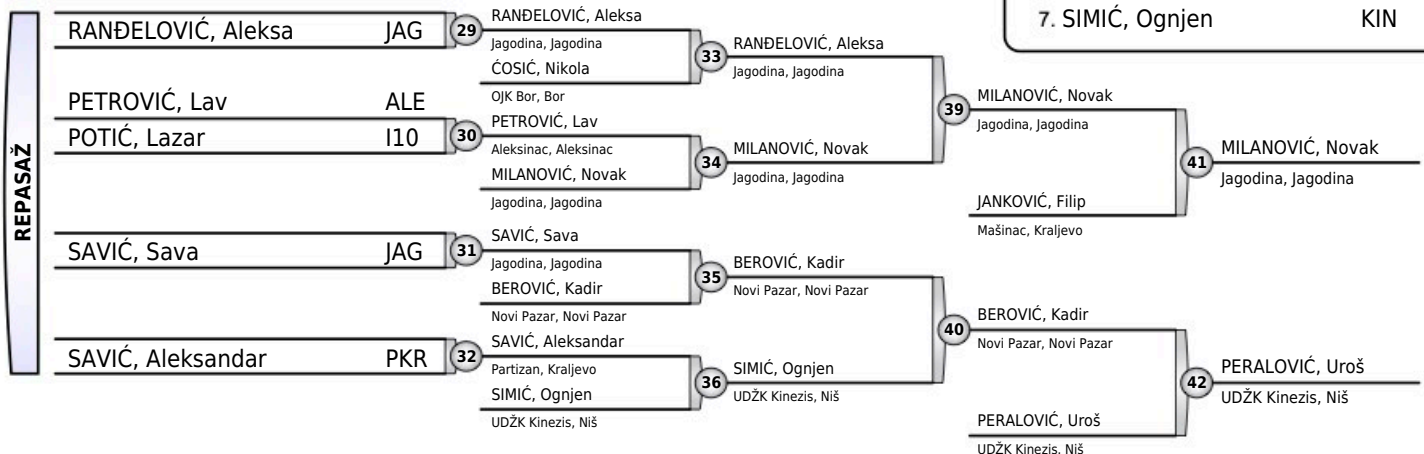



REGIONALNO CS JUNIORI

Požarevac, 19.04.2026.

Juniori
-81KG
10 takmičara

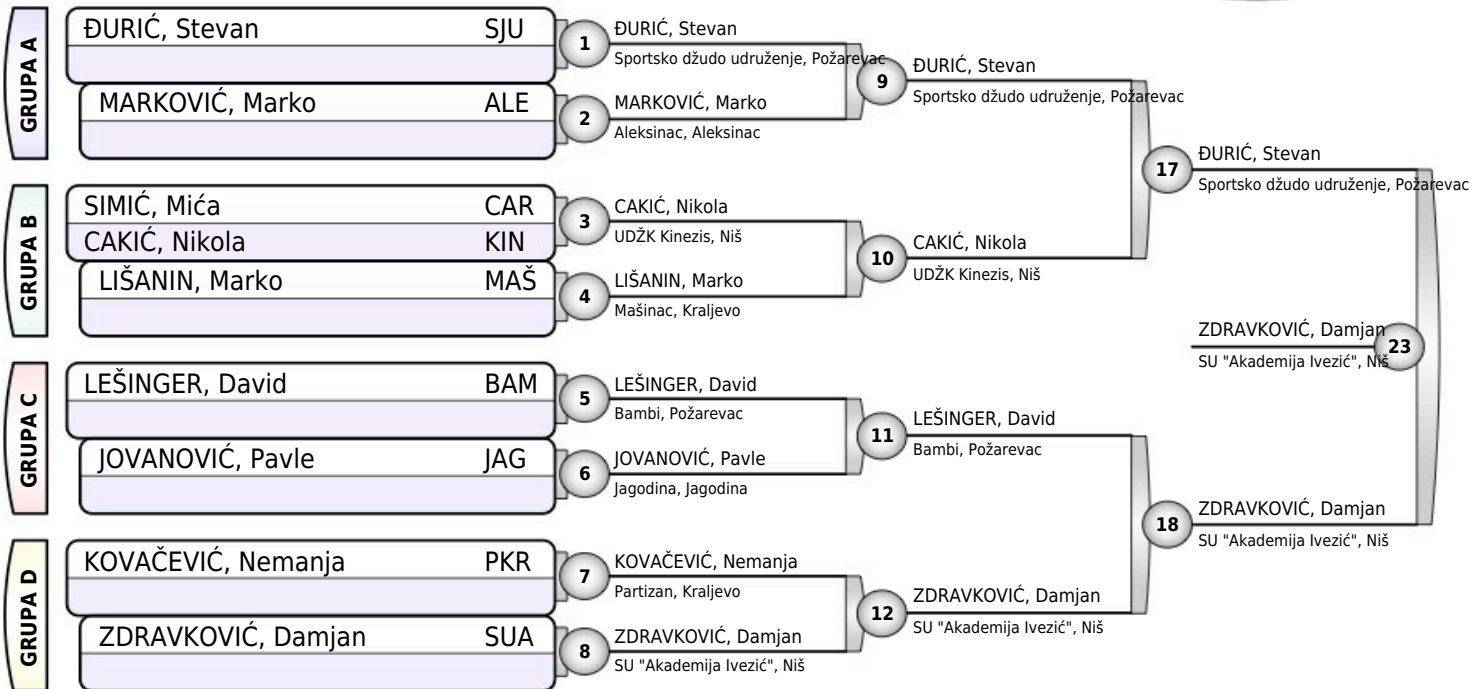

Rezultati

1. ZDRAVKOVIĆ, Damjan SUA
2. ĐURIĆ, Stevan SJU
3. MARKOVIĆ, Marko ALE
3. CAKIĆ, Nikola KIN
5. LEŠINGER, David BAM
5. JOVANOVIĆ, Pavle JAG
7. SIMIĆ, Mića CAR
7. KOVAČEVIĆ, Nemanja PKR

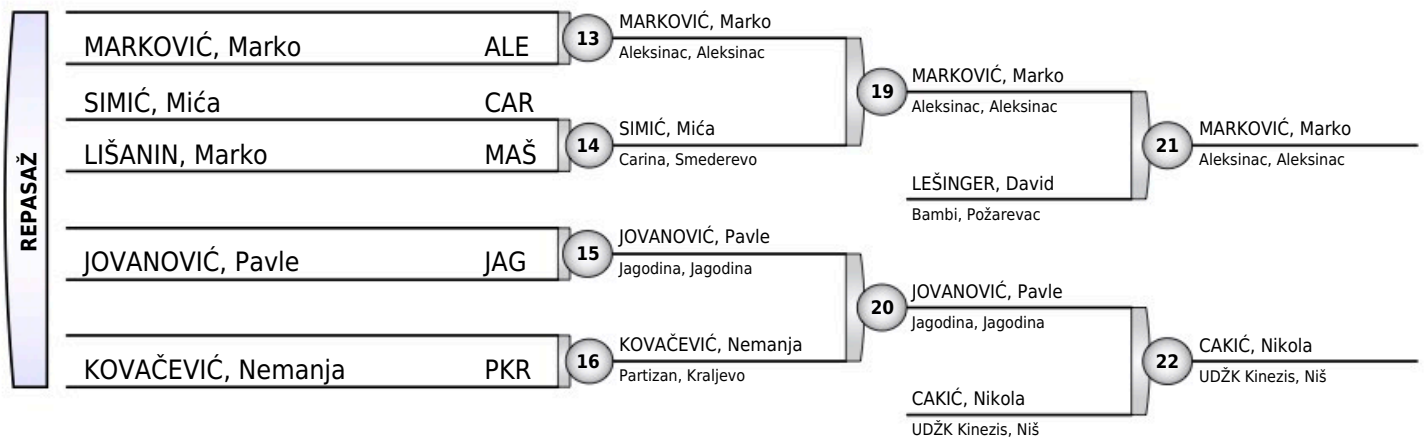



REGIONALNO CS JUNIORI

Požarevac, 19.04.2026.

Juniori
-90KG
10 takmičara

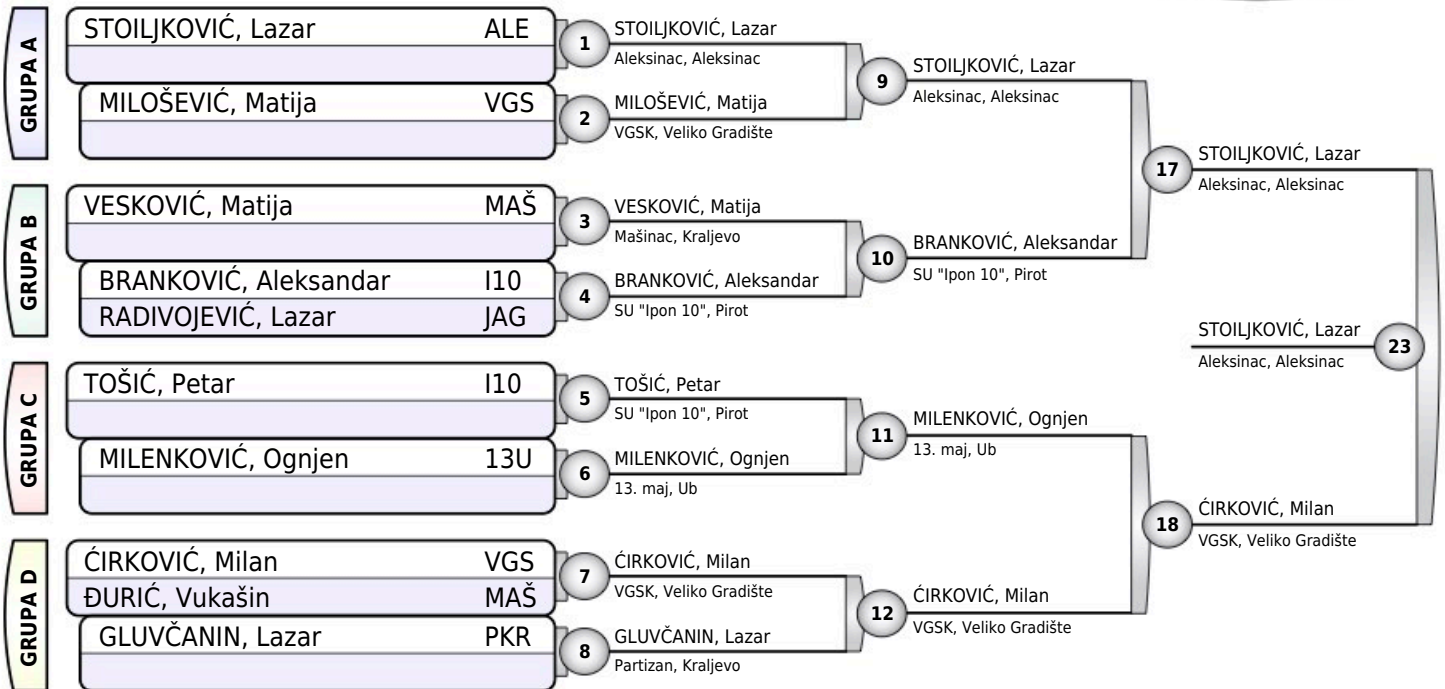

Rezultati

1. STOILJKOVIĆ, Lazar ALE
2. ĆIRKOVIĆ, Milan VGS
3. MILENKOVIĆ, Ognjen 13U
3. BRANKOVIĆ, Aleksandar I10
5. RADIVOJEVIĆ, Lazar JAG
5. TOŠIĆ, Petar I10
7. MILOŠEVIĆ, Matija VGS
7. GLUVČANIN, Lazar PKR

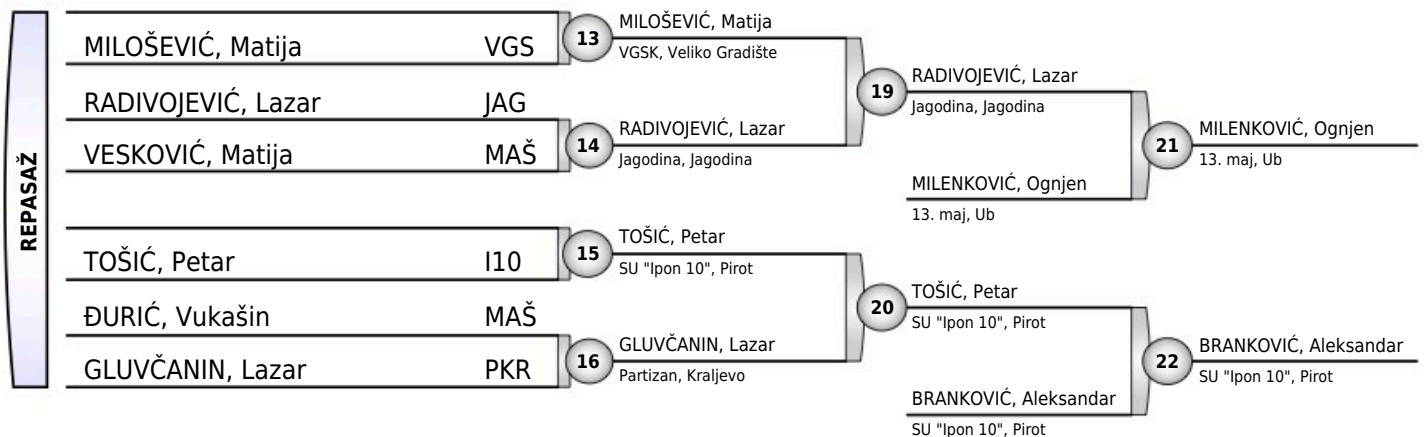



REGIONALNO CS JUNIORI

Požarevac, 19.04.2026.

Juniori
-100KG
5 takmičara

Takmičar i klub	1	2	3	4	5	Pobeda	Bodova	Mesto
1 NIKOLIĆ, Marko SU "Ipon 10", Pirot		0	0	0	0	0	0	5
2 MILOJKOVIĆ, Mihajlo Aleksinac, Aleksinac	100		100	1	0	3	201	2
3 TRAJKOVIĆ, Luka Aleksinac, Aleksinac	100	0		0	0	1	100	3
4 POPOVIĆ, Lazar 13. maj, Ub	100	0	100		0	2	200	3
5 ŠUNDOVIĆ, Veljko Mašinac, Kraljevo	100	100	100	100		4	400	1

NIKOLIĆ, Marko	I10	1	MILOJKOVIĆ, Mihajlo
MILOJKOVIĆ, Mihajlo	ALE		Aleksinac, Aleksinac
TRAJKOVIĆ, Luka	ALE	2	POPOVIĆ, Lazar
POPOVIĆ, Lazar	13U		13. maj, Ub
NIKOLIĆ, Marko	I10	3	ŠUNDOVIĆ, Veljko
ŠUNDOVIĆ, Veljko	MAŠ		Mašinac, Kraljevo
MILOJKOVIĆ, Mihajlo	ALE	4	MILOJKOVIĆ, Mihajlo
TRAJKOVIĆ, Luka	ALE		Aleksinac, Aleksinac
POPOVIĆ, Lazar	13U	5	ŠUNDOVIĆ, Veljko
ŠUNDOVIĆ, Veljko	MAŠ		Mašinac, Kraljevo
NIKOLIĆ, Marko	I10	6	TRAJKOVIĆ, Luka
TRAJKOVIĆ, Luka	ALE		Aleksinac, Aleksinac
MILOJKOVIĆ, Mihajlo	ALE	7	MILOJKOVIĆ, Mihajlo
POPOVIĆ, Lazar	13U		Aleksinac, Aleksinac
TRAJKOVIĆ, Luka	ALE	8	ŠUNDOVIĆ, Veljko
ŠUNDOVIĆ, Veljko	MAŠ		Mašinac, Kraljevo
NIKOLIĆ, Marko	I10	9	POPOVIĆ, Lazar
POPOVIĆ, Lazar	13U		13. maj, Ub
MILOJKOVIĆ, Mihajlo	ALE	10	ŠUNDOVIĆ, Veljko
ŠUNDOVIĆ, Veljko	MAŠ		Mašinac, Kraljevo

Rezultati

- | | |
|------------------------|-----|
| 1. ŠUNDOVIĆ, Veljko | MAŠ |
| 2. MILOJKOVIĆ, Mihajlo | ALE |
| 3. POPOVIĆ, Lazar | 13U |
| 3. TRAJKOVIĆ, Luka | ALE |
| 5. NIKOLIĆ, Marko | I10 |



REGIONALNO CS JUNIORI

Požarevac, 19.04.2026.

Juniori +100KG

7 takmičara

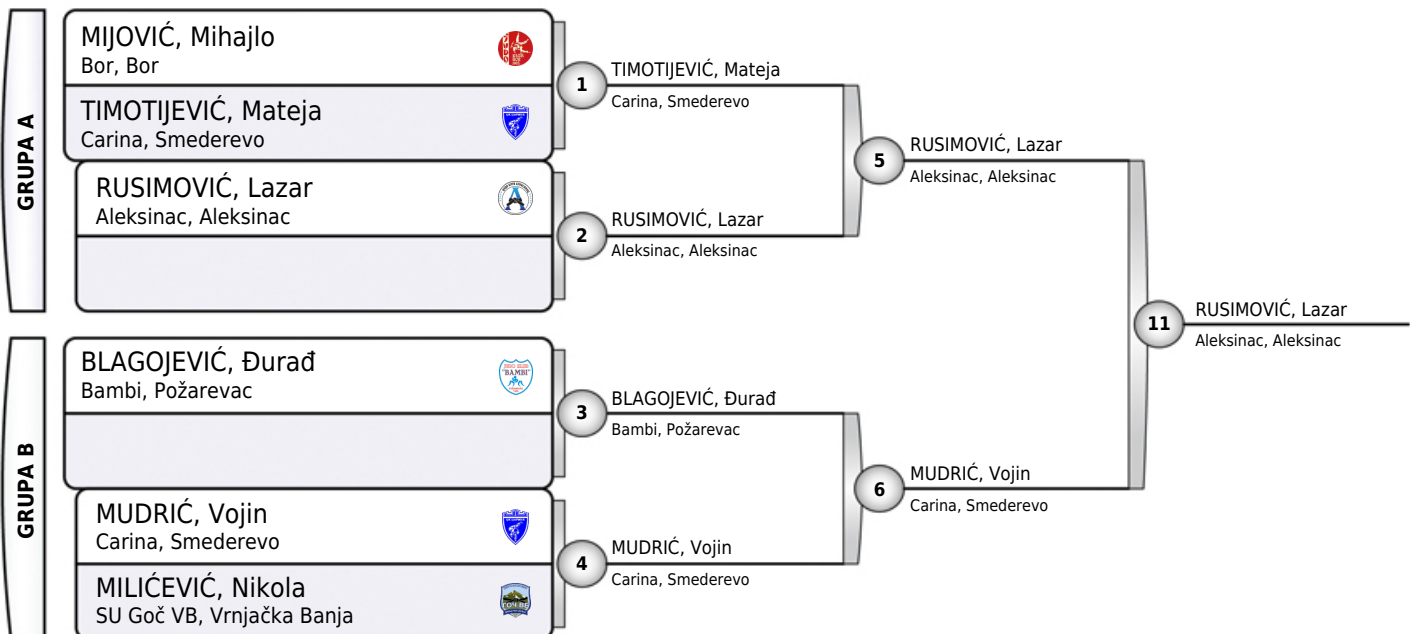

Rezultati

1. RUSIMOVIĆ, Lazar ALE
2. MUDRIĆ, Vojin CAR
3. BLAGOJEVIĆ, Đurađ BAM
3. TIMOTIJEVIĆ, Mateja CAR
5. MIJOVIĆ, Mihajlo BOR
5. MILIĆEVIĆ, Nikola GVB
- 7.
- 7.

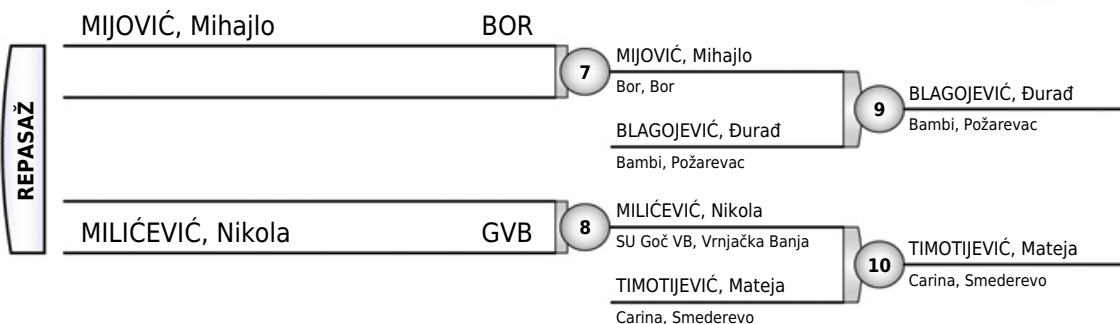



REGIONALNO CS JUNIORI

Požarevac, 19.04.2026.

Juniorke

-48KG

2 takmičarke

RAJKOVIĆ, Anja	JAG	1	RAJKOVIĆ, Anja
JOVIĆ, Mia	BAM		Jagodina, Jagodina
RAJKOVIĆ, Anja	JAG	2	RAJKOVIĆ, Anja
JOVIĆ, Mia	BAM		Jagodina, Jagodina
RAJKOVIĆ, Anja	JAG	3	
JOVIĆ, Mia	BAM		

Rezultati

1. RAJKOVIĆ, Anja JAG
2. JOVIĆ, Mia BAM



REGIONALNO CS JUNIORI

Požarevac, 19.04.2026.

Juniorke
-52KG
2 takmičarke

JELIĆ, Višnja	13U	1	POTIĆ, Maša
POTIĆ, Maša	I10		SU "Ipon 10", Piro
JELIĆ, Višnja	13U	2	JELIĆ, Višnja
POTIĆ, Maša	I10		13. maj, Ub
JELIĆ, Višnja	13U	3	JELIĆ, Višnja
POTIĆ, Maša	I10		13. maj, Ub

Rezultati

1. JELIĆ, Višnja	13U
2. POTIĆ, Maša	I10



REGIONALNO CS JUNIORI

Požarevac, 19.04.2026.

Juniorke
-57KG
8 takmičarki

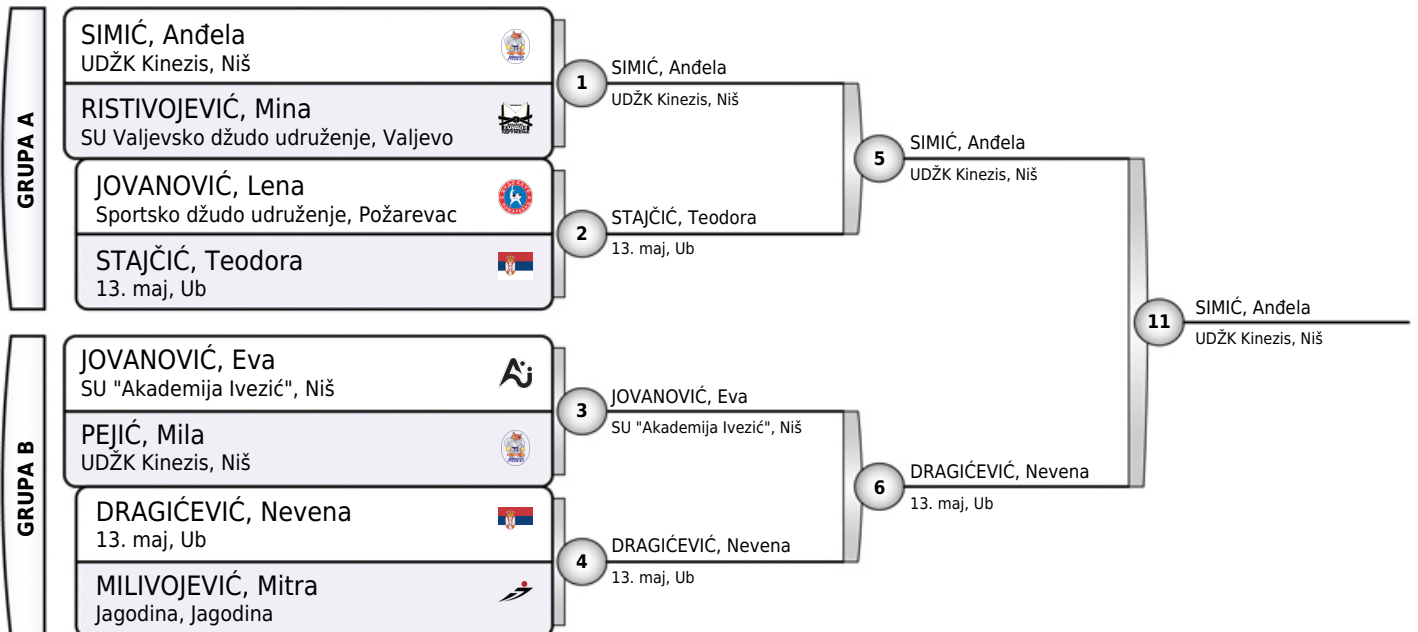

Rezultati

1. SIMIĆ, Anđela	KIN
2. DRAGIĆEVIĆ, Nevena	13U
3. JOVANOVIĆ, Eva	SUA
3. STAJČIĆ, Teodora	13U
5. JOVANOVIĆ, Lena	SJU
5. MILIVOJEVIĆ, Mitra	JAG
7. RISTIVOJEVIĆ, Mina	VJU
7. PEJIĆ, Mila	KIN

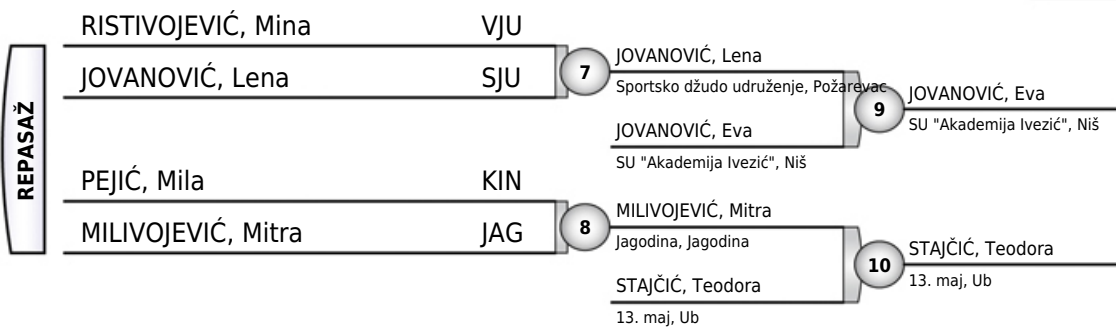



REGIONALNO CS JUNIORI

Požarevac, 19.04.2026.

Juniorke

-63KG

5 takmičarki

Takmičar i klub	1	2	3	4	5	Pobeda	Bodova	Mesto
1 BOLJANOVIĆ, Anja OJK Bor, Bor	///	0	100	0	0	1	100	3
2 SKOČAJIĆ, Elena Mašinac, Kraljevo	100	///	100	0	0	2	200	3
3 ĐOKIĆ, Elena UDŽK Kinezis, Niš	0	0	///	0	0	0	0	5
4 NIĆIFOROVIĆ, Đurđa Jagodina, Jagodina	100	1	100	///	100	4	301	1
5 POPOVIĆ, Sara 13. maj, Ub	100	100	100	0	///	3	300	2

BOLJANOVIĆ, Anja	OBO	1	SKOČAJIĆ, Elena
SKOČAJIĆ, Elena	MAŠ		Mašinac, Kraljevo
ĐOKIĆ, Elena	KIN	2	NIĆIFOROVIĆ, Đurđa
NIĆIFOROVIĆ, Đurđa	JAG		Jagodina, Jagodina
BOLJANOVIĆ, Anja	OBO	3	POPOVIĆ, Sara
POPOVIĆ, Sara	13U		13. maj, Ub
SKOČAJIĆ, Elena	MAŠ	4	SKOČAJIĆ, Elena
ĐOKIĆ, Elena	KIN		Mašinac, Kraljevo
NIĆIFOROVIĆ, Đurđa	JAG	5	NIĆIFOROVIĆ, Đurđa
POPOVIĆ, Sara	13U		Jagodina, Jagodina
BOLJANOVIĆ, Anja	OBO	6	BOLJANOVIĆ, Anja
ĐOKIĆ, Elena	KIN		OJK Bor, Bor
SKOČAJIĆ, Elena	MAŠ	7	NIĆIFOROVIĆ, Đurđa
NIĆIFOROVIĆ, Đurđa	JAG		Jagodina, Jagodina
ĐOKIĆ, Elena	KIN	8	POPOVIĆ, Sara
POPOVIĆ, Sara	13U		13. maj, Ub
BOLJANOVIĆ, Anja	OBO	9	NIĆIFOROVIĆ, Đurđa
NIĆIFOROVIĆ, Đurđa	JAG		Jagodina, Jagodina
SKOČAJIĆ, Elena	MAŠ	10	POPOVIĆ, Sara
POPOVIĆ, Sara	13U		13. maj, Ub

Rezultati

1. NIĆIFOROVIĆ, Đurđa JAG
2. POPOVIĆ, Sara 13U
3. SKOČAJIĆ, Elena MAŠ
3. BOLJANOVIĆ, Anja OBO
5. ĐOKIĆ, Elena KIN



REGIONALNO CS JUNIORI

Požarevac, 19.04.2026.

Juniorke
-70KG
3 takmičarke

Takmičar i klub	1	2	3	Pobeda	Bodova	Mesto
1 JOVIĆ, Magdalena Kučevo, Kučevo		0	100	1	100	2
2 IVANOVIĆ, Anđela UDŽK Kinezis, Niš	100		100	2	200	1
3 RISTIĆ, Petra Aleksinac, Aleksinac	0	0		0	0	3

JOVIĆ, Magdalena	KUČ	1	IVANOVIĆ, Anđela
IVANOVIĆ, Anđela	KIN		UDŽK Kinezis, Niš
JOVIĆ, Magdalena	KUČ	2	JOVIĆ, Magdalena
RISTIĆ, Petra	ALE		Kučevo, Kučevo
IVANOVIĆ, Anđela	KIN	3	IVANOVIĆ, Anđela
RISTIĆ, Petra	ALE		UDŽK Kinezis, Niš

Rezultati

- | | |
|---------------------|-----|
| 1. IVANOVIĆ, Anđela | KIN |
| 2. JOVIĆ, Magdalena | KUČ |
| 3. RISTIĆ, Petra | ALE |



REGIONALNO CS JUNIORI

Požarevac, 19.04.2026.

Juniorke
-78KG
2 takmičarke

RADISAVLJEVIĆ, Marija	PKR	1	RADISAVLJEVIĆ, Marija Partizan, Kraljevo
DUŠANIĆ, Dunja	OBO		
RADISAVLJEVIĆ, Marija	PKR	2	RADISAVLJEVIĆ, Marija Partizan, Kraljevo
DUŠANIĆ, Dunja	OBO		
RADISAVLJEVIĆ, Marija	PKR	3	
DUŠANIĆ, Dunja	OBO		

Rezultati

1. RADISAVLJEVIĆ, Marija PKR
2. DUŠANIĆ, Dunja OBO



REGIONALNO CS JUNIORI

Požarevac, 19.04.2026.

Juniorke
+78KG
3 takmičarke

Takmičar i klub	1	2	3	Pobeda	Bodova	Mesto
1 PAUNOVIĆ, Helena Kučevo, Kučevo		0	100	1	100	2
2 ĐORĐEVIĆ, Teodora SU Goč VB, Vrnjačka Banja	100		100	2	200	1
3 ĐORĐEVIĆ, Anđela Župa Aleksandrovac, Aleksandrovac	0	0		0	0	3

PAUNOVIĆ, Helena	KUČ	1	ĐORĐEVIĆ, Teodora
ĐORĐEVIĆ, Teodora	GVB		SU Goč VB, Vrnjačka Banja
PAUNOVIĆ, Helena	KUČ	2	PAUNOVIĆ, Helena
ĐORĐEVIĆ, Anđela	ŽAL		Kučevo, Kučevo
ĐORĐEVIĆ, Teodora	GVB	3	ĐORĐEVIĆ, Teodora
ĐORĐEVIĆ, Anđela	ŽAL		SU Goč VB, Vrnjačka Banja

Rezultati

- | | |
|----------------------|-----|
| 1. ĐORĐEVIĆ, Teodora | GVB |
| 2. PAUNOVIĆ, Helena | KUČ |
| 3. ĐORĐEVIĆ, Anđela | ŽAL |