



SOKOBANJA OPEN 2026

Sokobanja, 20.06.2026.

Stariji poletarci

-25KG

7 takmičara

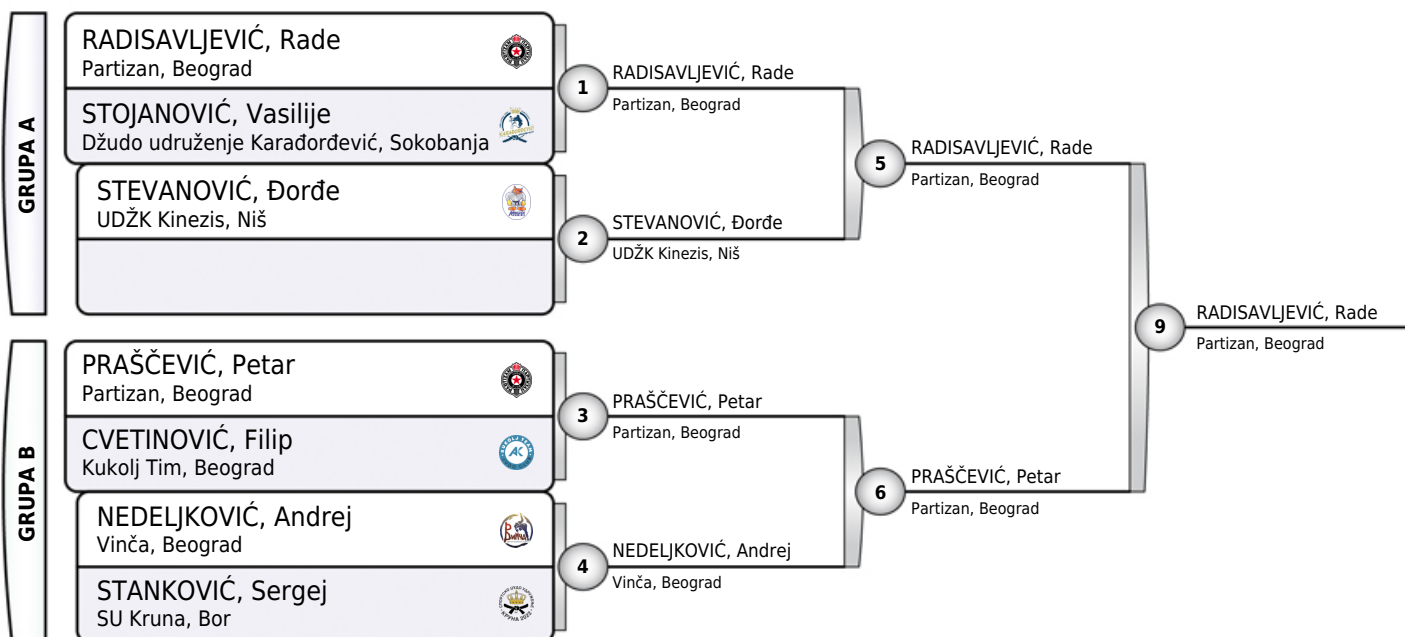

Rezultati

1. RADISAVLJEVIĆ, Rade PBG
2. PRAŠČEVIĆ, Petar PBG
3. STEVANOVIĆ, Đorđe KIN
3. NEDELJKOVIĆ, Andrej VIN
5. STOJANOVIĆ, Vasilije KAR
5. CVETINOVIĆ, Filip KTB
- 7.
- 7.





SOKOBANJA OPEN 2026

Sokobanja, 20.06.2026.

Stariji poletarci

-28KG

12 takmičara

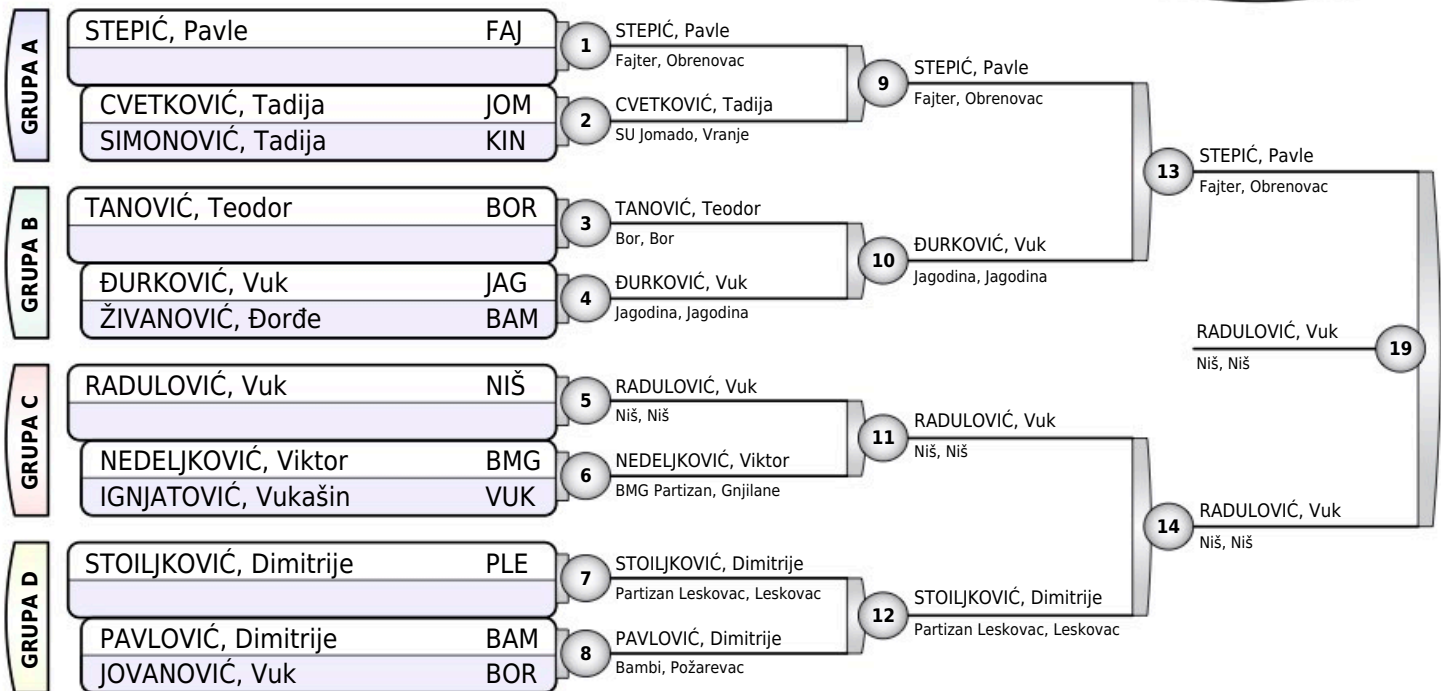

Rezultati

1. RADULOVIĆ, Vuk NIŠ
2. STEPIĆ, Pavle FAJ
3. CVETKOVIĆ, Tadija JOM
3. STOILJKOVIĆ, Dimitrije PLE
5. ĐURKOVIĆ, Vuk JAG
5. NEDELJKOVIĆ, Viktor BMG
- 7.
- 7.

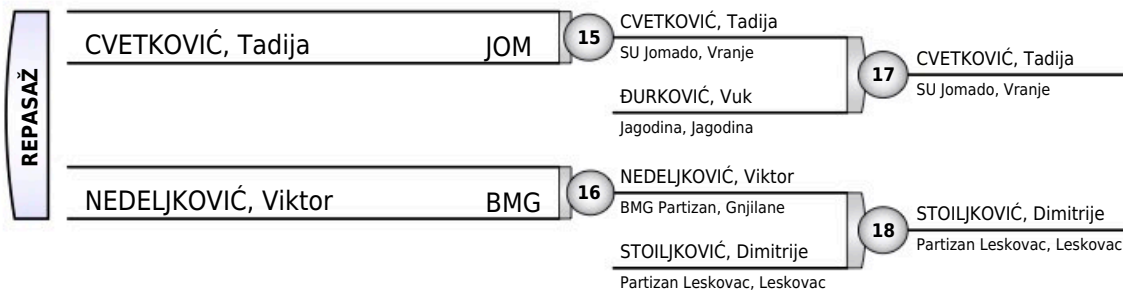



SOKOBANJA OPEN 2026

Sokobanja, 20.06.2026.

Stariji poletarci

-31KG

17 takmičara

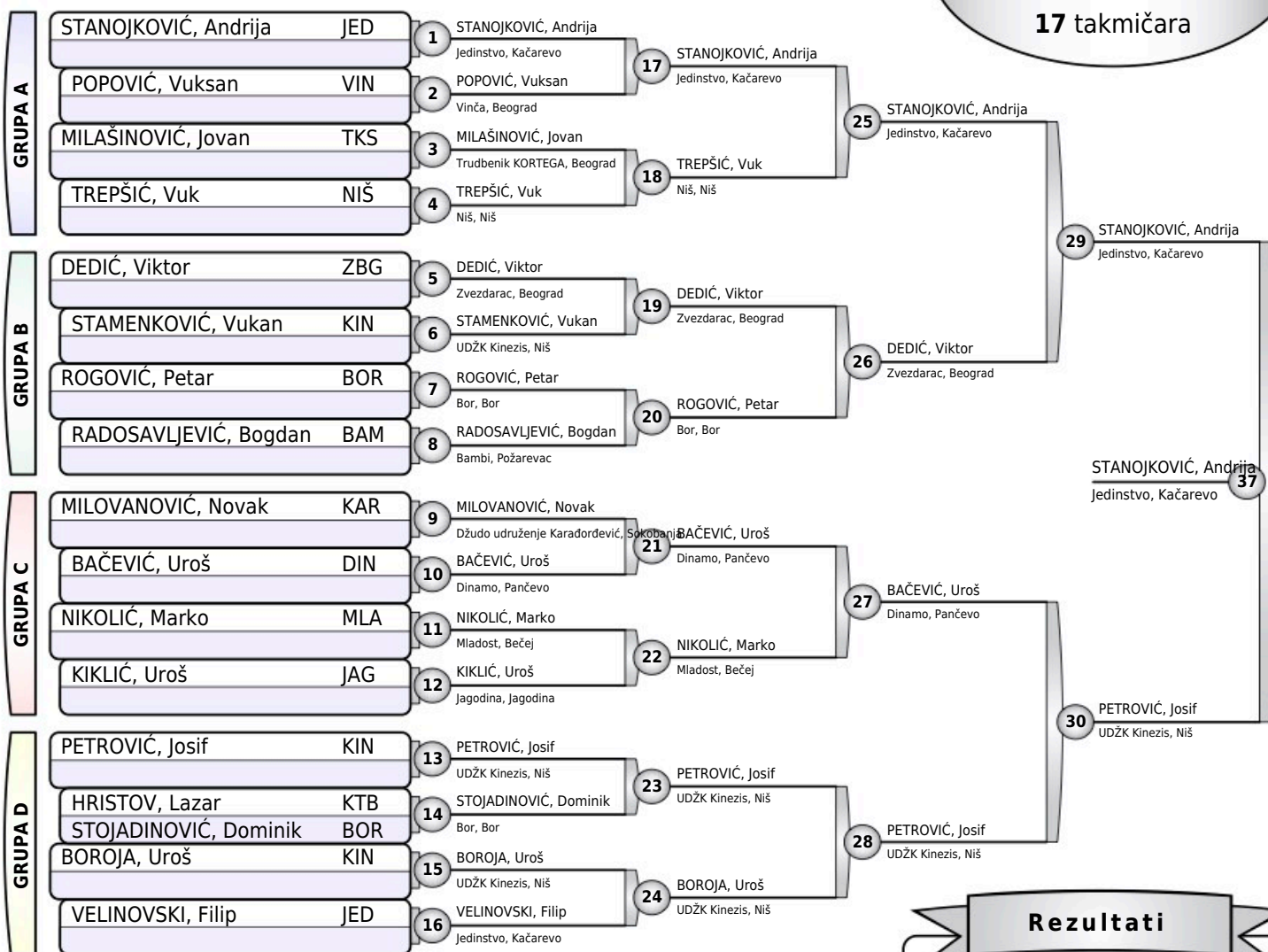

Rezultati

1. STANOJKOVIĆ, Andrija JED
2. PETROVIĆ, Josif KIN
3. DEDIĆ, Viktor ZBG
3. BAČEVIĆ, Uroš DIN
5. TREPŠIĆ, Vuk NIŠ
5. BOROJA, Uroš KIN
7. POPOVIĆ, Vuksan VIN
7. STOJADINOVIĆ, Dominik BOR



SOKOBANJA OPEN 2026

Sokobanja, 20.06.2026.

Stariji poletarci

-34KG

16 takmičara

GRUPA	Ime	Klub	Redni broj	Ime	Klub	Redni broj	Ime	Klub	Redni broj	
GRUPA A	ANDREJEVIĆ, Bogdan	KAR	1	ANDREJEVIĆ, Bogdan	Džudo udruženje Karadordević, Sokobanja	9	ANDREJEVIĆ, Bogdan	Džudo udruženje Karadordević, Sokobanja	13	
	BAJČETIĆ, Luka	KTB	2	TRBIĆ, Aleksa	Bor, Bor	10	BOŽIĆ, Nikola	Bor, Bor	19	
	MATOVIĆ, Rastko	ZBG		TRBIĆ, Aleksa	Bor, Bor		BOŽIĆ, Nikola	Bor, Bor		
	TRBIĆ, Aleksa	BOR	JEREMIĆ, Andrija	KTB	3	JEREMIĆ, Andrija	Kukolj Tim, Beograd	10	BOŽIĆ, Nikola	Bor, Bor
GRUPA B	ANĐELKOVIĆ, Uroš	KIN	3	BOŽIĆ, Nikola	BOR	4	NEDOVIĆ, Vaso	ZBG	11	
	ĐORĐEVIĆ, Tika	KAR		5	ĐORĐEVIĆ, Tika		Džudo udruženje Karadordević, Sokobanja	11		ĐORĐEVIĆ, Tika
	ANĐELKOVIĆ, Stefan	KTB	ANĐELKOVIĆ, Stefan	STOJANOVIĆ, Nikola	PLE	6	STOJANOVIĆ, Nikola	Partizan Leskovac, Leskovac	14	
	STOJANOVIĆ, Nikola	PLE	MARKOVIĆ, Filip	BOR	OBRADOVIĆ, Strahinja	JAG	7	OBRADOVIĆ, Strahinja	Jagodina, Jagodina	12
GRUPA C	MARKOVIĆ, Filip	BOR	7	IGNJATOVIĆ, Vasilije	VUK	8	LUKIĆ, Toma	034	17	
	OBRADOVIĆ, Strahinja	JAG		IGNJATOVIĆ, Vasilije	VUK		8	LUKIĆ, Toma		SU Radnički 034, Kragujevac
	OBRADOVIĆ, Strahinja	JAG	CVETKOVIĆ, Aljoša	KIN	ANĐELKOVIĆ, Stefan	KTB	15	BAJČETIĆ, Luka	Kukolj Tim, Beograd	17
	CVETKOVIĆ, Aljoša	KIN	STOJANOVIĆ, Nikola	PLE	16	STOJANOVIĆ, Nikola	Partizan Leskovac, Leskovac	18	OBRADOVIĆ, Strahinja	Jagodina, Jagodina
GRUPA D	CVETKOVIĆ, Aljoša	KIN	15	BOŽIĆ, Nikola	Bor, Bor	17	BOŽIĆ, Nikola	Bor, Bor	18	
	BAJČETIĆ, Luka	KTB		TRBIĆ, Aleksa	BOR		BOŽIĆ, Nikola	Bor, Bor		
	TRBIĆ, Aleksa	BOR	ANĐELKOVIĆ, Stefan	KTB	16	STOJANOVIĆ, Nikola	Partizan Leskovac, Leskovac	18	OBRADOVIĆ, Strahinja	Jagodina, Jagodina
	ANĐELKOVIĆ, Stefan	KTB	STOJANOVIĆ, Nikola	PLE	16	STOJANOVIĆ, Nikola	Partizan Leskovac, Leskovac	18	OBRADOVIĆ, Strahinja	Jagodina, Jagodina
REPASAŽ	STOJANOVIĆ, Nikola	PLE	16	OBRADOVIĆ, Strahinja	Jagodina, Jagodina	18	OBRADOVIĆ, Strahinja	Jagodina, Jagodina	18	
	OBRADOVIĆ, Strahinja	JAG		OBRADOVIĆ, Strahinja	Jagodina, Jagodina					
	OBRADOVIĆ, Strahinja	JAG	BAJČETIĆ, Luka	KTB	15	BAJČETIĆ, Luka	Kukolj Tim, Beograd	17	BOŽIĆ, Nikola	Bor, Bor
	BAJČETIĆ, Luka	KTB	TRBIĆ, Aleksa	BOR	15	BAJČETIĆ, Luka	Kukolj Tim, Beograd	17	BOŽIĆ, Nikola	Bor, Bor

Rezultati

- ANDREJEVIĆ, Bogdan KAR
- ĐORĐEVIĆ, Tika KAR
- BOŽIĆ, Nikola BOR
- OBRADOVIĆ, Strahinja JAG
- BAJČETIĆ, Luka KTB
- STOJANOVIĆ, Nikola PLE
- TRBIĆ, Aleksa BOR
- ANĐELKOVIĆ, Stefan KTB

REPASAŽ	BAJČETIĆ, Luka	KTB	15	BAJČETIĆ, Luka	Kukolj Tim, Beograd	17	BOŽIĆ, Nikola	Bor, Bor
	TRBIĆ, Aleksa	BOR		BOŽIĆ, Nikola	Bor, Bor			
	ANĐELKOVIĆ, Stefan	KTB	16	STOJANOVIĆ, Nikola	Partizan Leskovac, Leskovac	18	OBRADOVIĆ, Strahinja	Jagodina, Jagodina
	STOJANOVIĆ, Nikola	PLE		OBRADOVIĆ, Strahinja	Jagodina, Jagodina			



SOKOBANJA OPEN 2026

Sokobanja, 20.06.2026.

Stariji poletarci

-38KG

15 takmičara

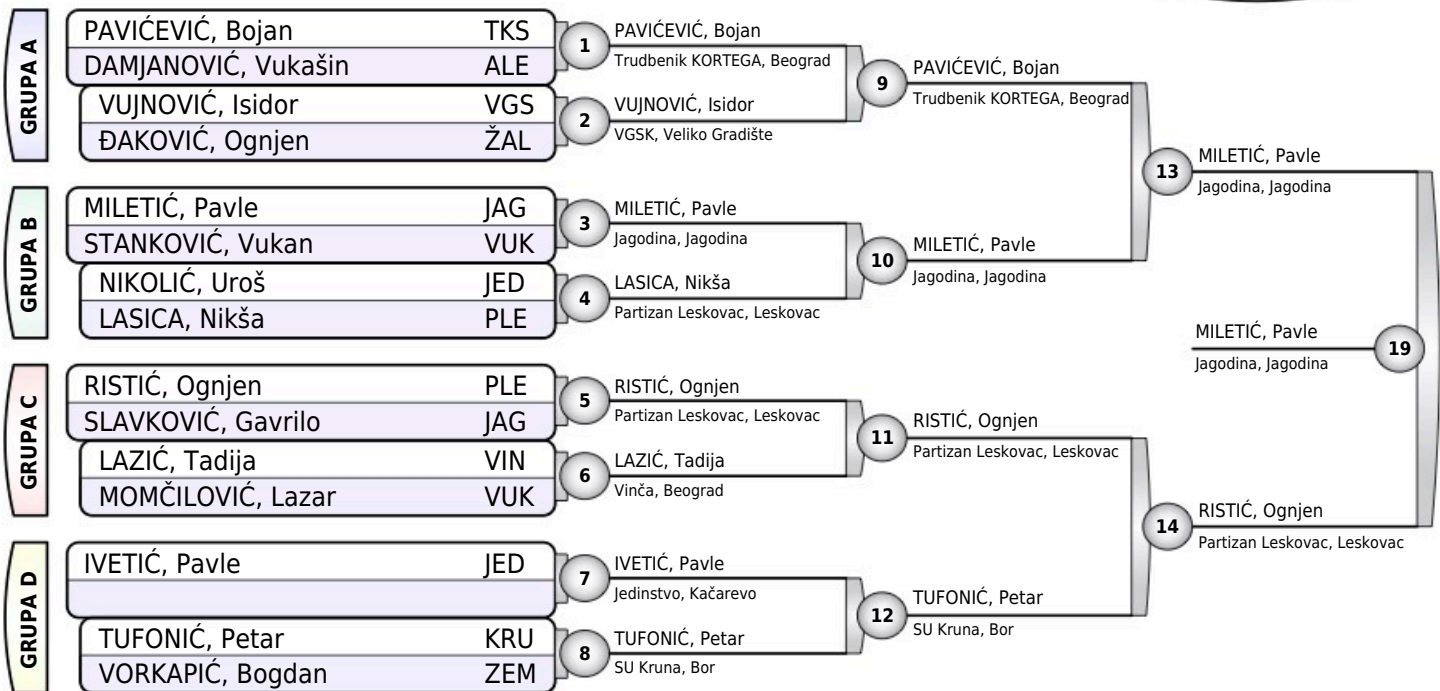

Rezultati

- | | | |
|----|---------------------|-----|
| 1. | MILETIĆ, Pavle | JAG |
| 2. | RISTIĆ, Ognjen | PLE |
| 3. | PAVIĆEVIĆ, Bojan | TKS |
| 3. | TUFONIĆ, Petar | KRU |
| 5. | LASICA, Nikša | PLE |
| 5. | LAZIĆ, Tadija | VIN |
| 7. | STANKOVIĆ, Vukan | VUK |
| 7. | SLAVKOVIĆ, Gavriilo | JAG |

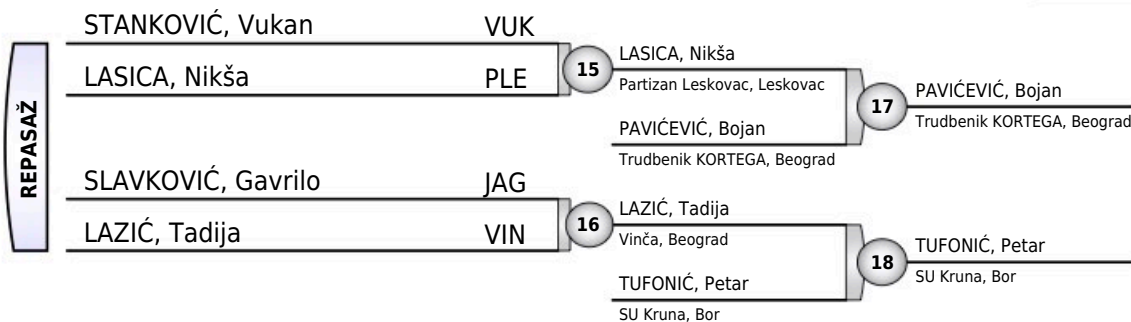



SOKOBANJA OPEN 2026

Sokobanja, 20.06.2026.

Stariji poletarci

-42KG

8 takmičara

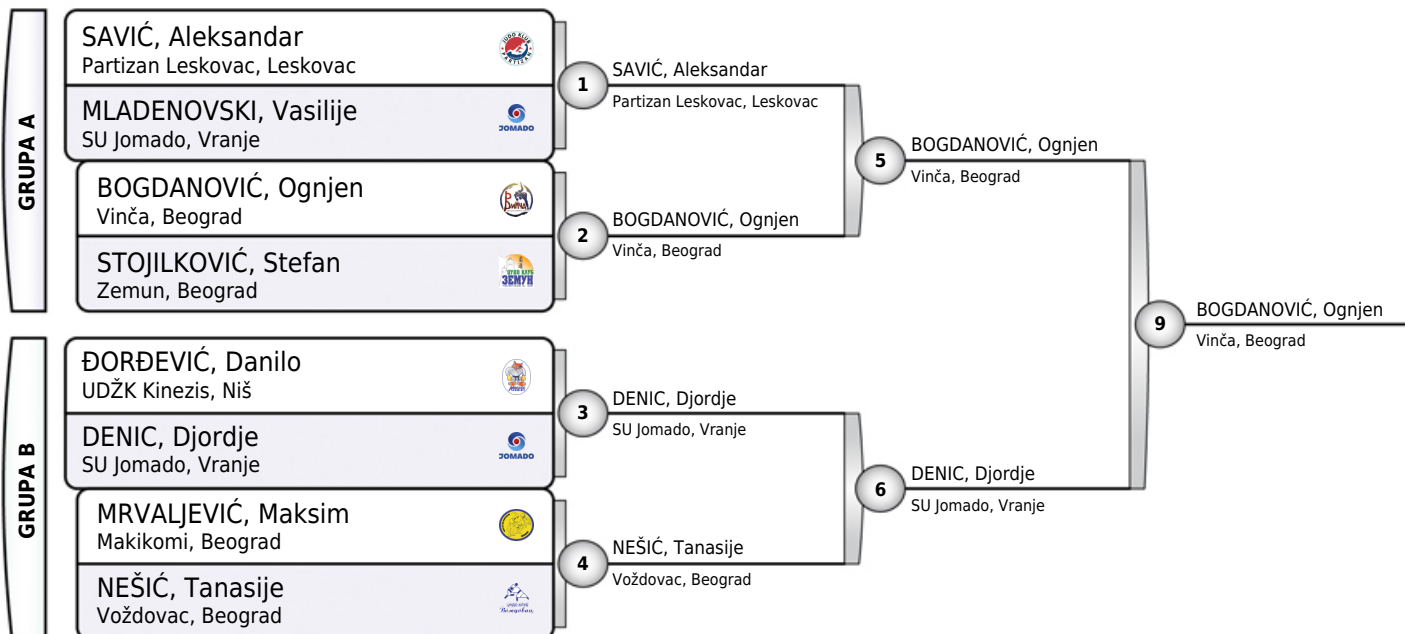

Rezultati

1. BOGDANOVIĆ, Ognjen VIN
2. DENIC, Djordje JOM
3. SAVIĆ, Aleksandar PLE
3. ĐORĐEVIĆ, Danilo KIN
5. STOJILKOVIĆ, Stefan ZEM
5. NEŠIĆ, Tanasije VOŽ
- 7.
- 7.

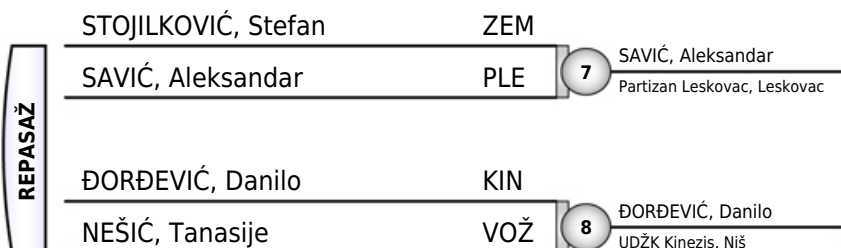



SOKOBANJA OPEN 2026

Sokobanja, 20.06.2026.

Stariji poletarci

-46KG

5 takmičara

Takmičar i klub	1	2	3	4	5	Pobeda	Bodova	Mesto
1 JANKOVIĆ, Vidak Zvezdarac, Beograd		0	0	10	0	1	10	3
2 ŠOŠKIĆ, Maksim Trudbenik KORTEGA, Beograd	100		1	100	1	4	202	1
3 JOTANOVIĆ, Lukas Mladost, Bečej	100	0		100	0	2	200	3
4 DERBOGOSIJAN, Veljko SU Goč VB, Vrnjačka Banja	0	0	0		0	0	0	5
5 PITULIĆ, Aleksandar Vinča, Beograd	100	0	100	100		3	300	2

JANKOVIĆ, Vidak	ZBG	1	ŠOŠKIĆ, Maksim
ŠOŠKIĆ, Maksim	TKS		Trudbenik KORTEGA, Beograd
JOTANOVIĆ, Lukas	MLA	2	JOTANOVIĆ, Lukas
DERBOGOSIJAN, Veljko	GVB		Mladost, Bečej
JANKOVIĆ, Vidak	ZBG	3	PITULIĆ, Aleksandar
PITULIĆ, Aleksandar	VIN		Vinča, Beograd
ŠOŠKIĆ, Maksim	TKS	4	ŠOŠKIĆ, Maksim
JOTANOVIĆ, Lukas	MLA		Trudbenik KORTEGA, Beograd
DERBOGOSIJAN, Veljko	GVB	5	PITULIĆ, Aleksandar
PITULIĆ, Aleksandar	VIN		Vinča, Beograd
JANKOVIĆ, Vidak	ZBG	6	JOTANOVIĆ, Lukas
JOTANOVIĆ, Lukas	MLA		Mladost, Bečej
ŠOŠKIĆ, Maksim	TKS	7	ŠOŠKIĆ, Maksim
DERBOGOSIJAN, Veljko	GVB		Trudbenik KORTEGA, Beograd
JOTANOVIĆ, Lukas	MLA	8	PITULIĆ, Aleksandar
PITULIĆ, Aleksandar	VIN		Vinča, Beograd
JANKOVIĆ, Vidak	ZBG	9	JANKOVIĆ, Vidak
DERBOGOSIJAN, Veljko	GVB		Zvezdarac, Beograd
ŠOŠKIĆ, Maksim	TKS	10	ŠOŠKIĆ, Maksim
PITULIĆ, Aleksandar	VIN		Trudbenik KORTEGA, Beograd

Rezultati

1. ŠOŠKIĆ, Maksim TKS
2. PITULIĆ, Aleksandar VIN
3. JOTANOVIĆ, Lukas MLA
3. JANKOVIĆ, Vidak ZBG
5. DERBOGOSIJAN, Veljko GVB



SOKOBANJA OPEN 2026

Sokobanja, 20.06.2026.

Stariji poletarci

-50KG

5 takmičara

Takmičar i klub	1	2	3	4	5	Pobeda	Bodova	Mesto
1 GRUJOVIĆ, Đorđe Bor, Bor		0	0	100	0	1	100	3
2 KOSTIĆ, Stefan Bambi, Požarevac	100		10	100	0	3	210	2
3 IVANOVIĆ, Danilo SU Valjevsko džudo udruženje, Valjevo	100	0		100	0	2	200	3
4 ANĐELOVIĆ, Leonardo SU Kruna, Bor	0	0	0		0	0	0	5
5 VRAČEVIĆ, Aleksej Kukolj Tim, Beograd	100	100	100	100		4	400	1

GRUJOVIĆ, Đorđe	BOR	1	KOSTIĆ, Stefan
KOSTIĆ, Stefan	BAM		Bambi, Požarevac
IVANOVIĆ, Danilo	VJU	2	IVANOVIĆ, Danilo
ANĐELOVIĆ, Leonardo	KRU		SU Valjevsko džudo udruženje, Valjevo
GRUJOVIĆ, Đorđe	BOR	3	VRAČEVIĆ, Aleksej
VRAČEVIĆ, Aleksej	KTB		Kukolj Tim, Beograd
KOSTIĆ, Stefan	BAM	4	KOSTIĆ, Stefan
IVANOVIĆ, Danilo	VJU		Bambi, Požarevac
ANĐELOVIĆ, Leonardo	KRU	5	VRAČEVIĆ, Aleksej
VRAČEVIĆ, Aleksej	KTB		Kukolj Tim, Beograd
GRUJOVIĆ, Đorđe	BOR	6	IVANOVIĆ, Danilo
IVANOVIĆ, Danilo	VJU		SU Valjevsko džudo udruženje, Valjevo
KOSTIĆ, Stefan	BAM	7	KOSTIĆ, Stefan
ANĐELOVIĆ, Leonardo	KRU		Bambi, Požarevac
IVANOVIĆ, Danilo	VJU	8	VRAČEVIĆ, Aleksej
VRAČEVIĆ, Aleksej	KTB		Kukolj Tim, Beograd
GRUJOVIĆ, Đorđe	BOR	9	GRUJOVIĆ, Đorđe
ANĐELOVIĆ, Leonardo	KRU		Bor, Bor
KOSTIĆ, Stefan	BAM	10	VRAČEVIĆ, Aleksej
VRAČEVIĆ, Aleksej	KTB		Kukolj Tim, Beograd

Rezultati

1. VRAČEVIĆ, Aleksej KTB
2. KOSTIĆ, Stefan BAM
3. IVANOVIĆ, Danilo VJU
3. GRUJOVIĆ, Đorđe BOR
5. ANĐELOVIĆ, Leonardo KRU



SOKOBANJA OPEN 2026

Sokobanja, 20.06.2026.

Stariji poletarci

+50KG

5 takmičara

Takmičar i klub	1	2	3	4	5	Pobeda	Bodova	Mesto
1 MARINKOVIĆ, Petar Akademija Todorović, Zaječar	0	0	100	0	0	1	100	3
2 ANTIĆ, Tadej Brus, Brus	100	0	100	10	1	4	211	1
3 SAVIĆ, Dimitrije Vuk, Niš	0	0	0	0	0	0	0	5
4 ZDRAVKOVIĆ, Luka Akademija Todorović, Zaječar	100	0	100	0	0	2	200	3
5 JAJIĆ, Jovan Mašinac, Kraljevo	1	0	1	100	0	3	102	2

MARINKOVIĆ, Petar	AKT	1	ANTIĆ, Tadej
ANTIĆ, Tadej	BRU		Brus, Brus
SAVIĆ, Dimitrije	VUK	2	ZDRAVKOVIĆ, Luka
ZDRAVKOVIĆ, Luka	AKT		Akademija Todorović, Zaječar
MARINKOVIĆ, Petar	AKT	3	JAJIĆ, Jovan
JAJIĆ, Jovan	MAŠ		Mašinac, Kraljevo
ANTIĆ, Tadej	BRU	4	ANTIĆ, Tadej
SAVIĆ, Dimitrije	VUK		Brus, Brus
ZDRAVKOVIĆ, Luka	AKT	5	JAJIĆ, Jovan
JAJIĆ, Jovan	MAŠ		Mašinac, Kraljevo
MARINKOVIĆ, Petar	AKT	6	MARINKOVIĆ, Petar
SAVIĆ, Dimitrije	VUK		Akademija Todorović, Zaječar
ANTIĆ, Tadej	BRU	7	ANTIĆ, Tadej
ZDRAVKOVIĆ, Luka	AKT		Brus, Brus
SAVIĆ, Dimitrije	VUK	8	JAJIĆ, Jovan
JAJIĆ, Jovan	MAŠ		Mašinac, Kraljevo
MARINKOVIĆ, Petar	AKT	9	ZDRAVKOVIĆ, Luka
ZDRAVKOVIĆ, Luka	AKT		Akademija Todorović, Zaječar
ANTIĆ, Tadej	BRU	10	ANTIĆ, Tadej
JAJIĆ, Jovan	MAŠ		Brus, Brus

Rezultati

1. ANTIĆ, Tadej BRU
2. JAJIĆ, Jovan MAŠ
3. ZDRAVKOVIĆ, Luka AKT
3. MARINKOVIĆ, Petar AKT
5. SAVIĆ, Dimitrije VUK



SOKOBANJA OPEN 2026

Sokobanja, 20.06.2026.

Starije poletarke

-25KG

2 takmičarke

JONOVIĆ, Sofija	KRU	1	RISTIĆ, Danka
RISTIĆ, Danka	KAR		Džudo udruženje Karađorđević, Sokobanja
JONOVIĆ, Sofija	KRU	2	JONOVIĆ, Sofija
RISTIĆ, Danka	KAR		SU Kruna, Bor
JONOVIĆ, Sofija	KRU	3	RISTIĆ, Danka
RISTIĆ, Danka	KAR		Džudo udruženje Karađorđević, Sokobanja

Rezultati

1. RISTIĆ, Danka KAR
2. JONOVIĆ, Sofija KRU



SOKOBANJA OPEN 2026

Sokobanja, 20.06.2026.

Starije poletarke

-28KG

11 takmičarki

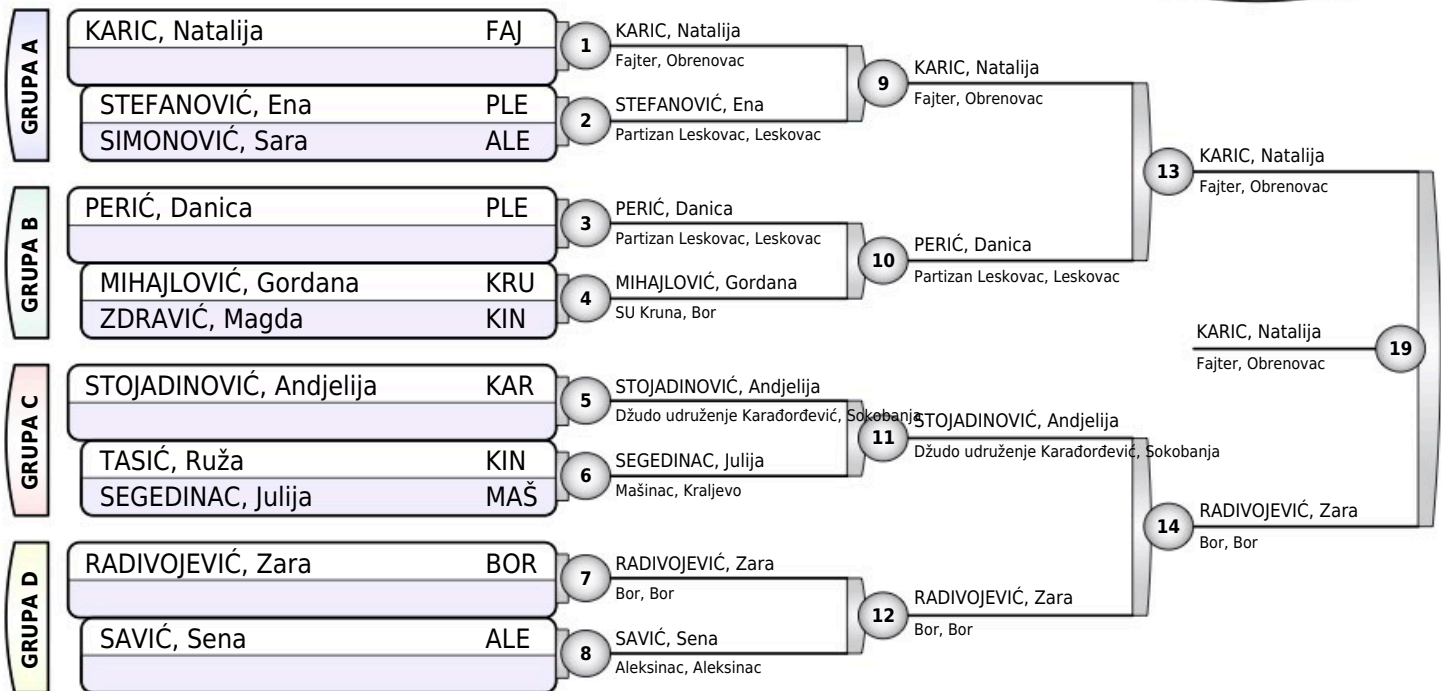

Rezultati

1. KARIC, Natalija FAJ
2. RADIVOJEVIĆ, Zara BOR
3. PERIĆ, Danica PLE
3. STOJADINOVIĆ, Andjelija KAR
5. STEFANOVIĆ, Ena PLE
5. SAVIĆ, Sena ALE
- 7.
- 7.





SOKOBANJA OPEN 2026

Sokobanja, 20.06.2026.

Starije poletarke

-31KG

6 takmičarki

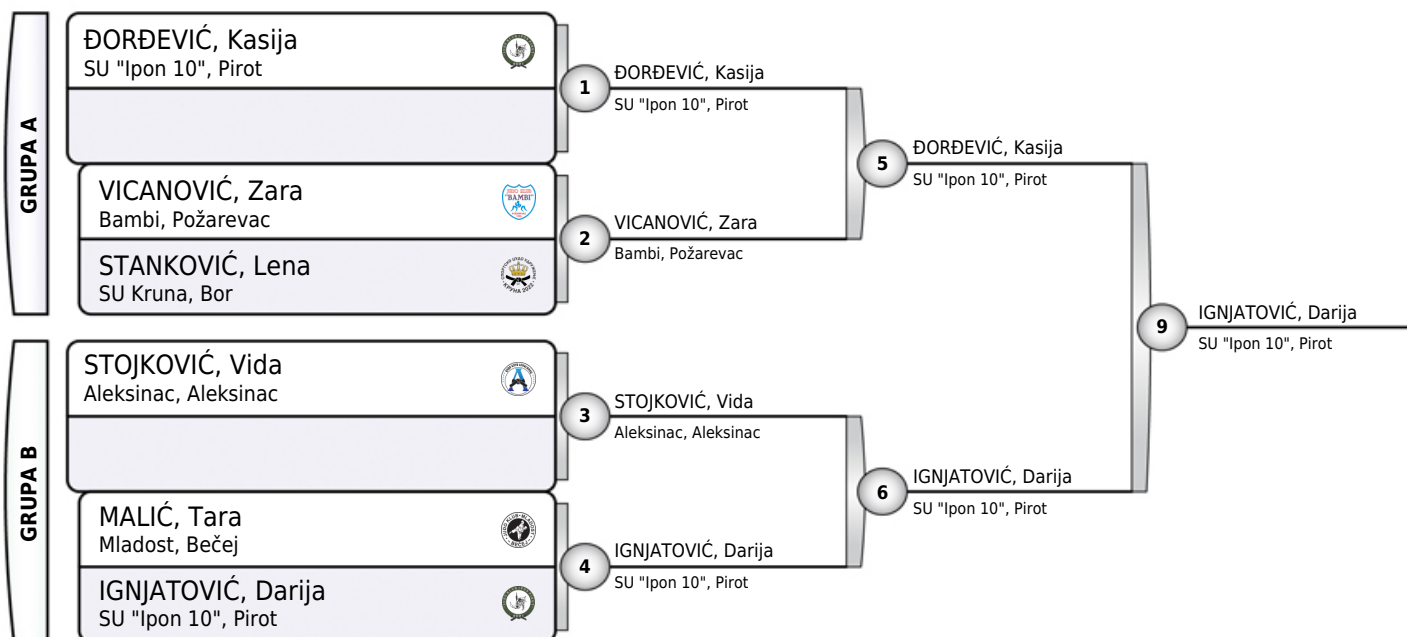

Rezultati

1. IGNJATOVIĆ, Darija I10
2. ĐORĐEVIĆ, Kasija I10
3. VICANOVIĆ, Zara BAM
3. STOJKOVIĆ, Vida ALE
5. MALIĆ, Tara MLA
- 5.
- 7.
- 7.

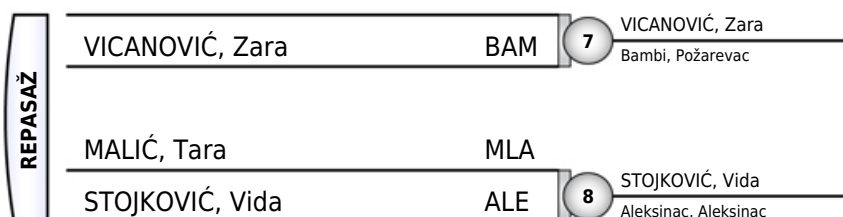



SOKOBANJA OPEN 2026

Sokobanja, 20.06.2026.

Starije poletarke

-34KG

2 takmičarke

ĐORĐEVIĆ, Nikolina	I10	1	RAKIĆ, Mina
RAKIĆ, Mina	ALE		Aleksinac, Aleksinac
ĐORĐEVIĆ, Nikolina	I10	2	RAKIĆ, Mina
RAKIĆ, Mina	ALE		Aleksinac, Aleksinac
ĐORĐEVIĆ, Nikolina	I10	3	
RAKIĆ, Mina	ALE		

Rezultati

1. RAKIĆ, Mina ALE
2. ĐORĐEVIĆ, Nikolina I10



SOKOBANJA OPEN 2026

Sokobanja, 20.06.2026.

Starije poletarke

-38KG

8 takmičarki

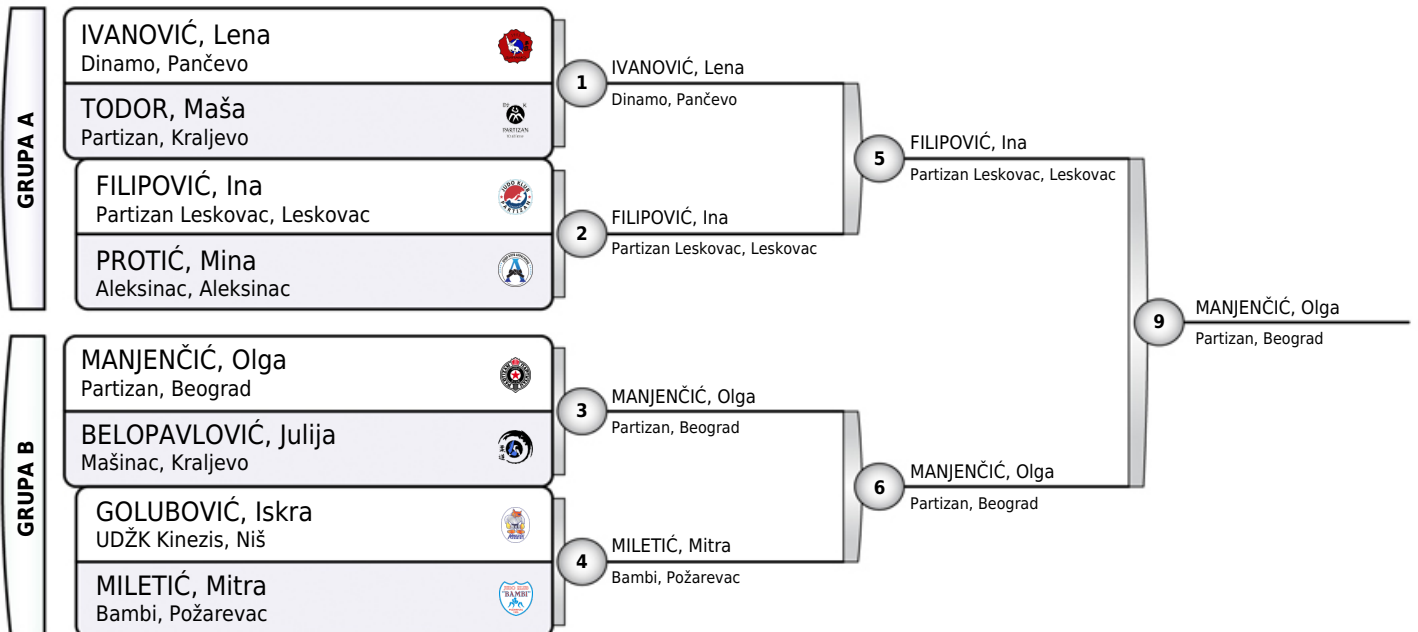

Rezultati

1. MANJENČIĆ, Olga PBG
2. FILIPOVIĆ, Ina PLE
3. IVANOVIĆ, Lena DIN
3. MILETIĆ, Mitra BAM
5. PROTIĆ, Mina ALE
5. BELOPAVLOVIĆ, Julija MAŠ
- 7.
- 7.

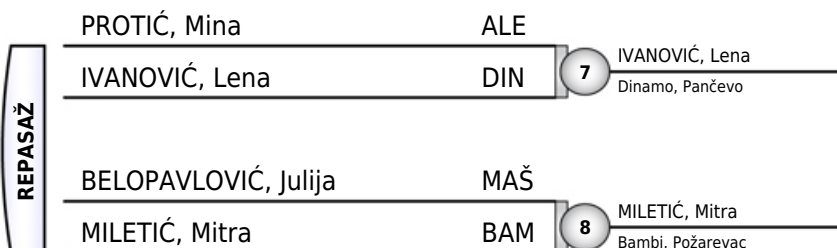



SOKOBANJA OPEN 2026

Sokobanja, 20.06.2026.

Starije poletarke

-43KG

5 takmičarki

Takmičar i klub	1	2	3	4	5	Pobeda	Bodova	Mesto
1 GNJATOVIĆ, Lena Voždovac, Beograd	10	0	100	0	2	110	3	
2 NIKOLIĆ, Marija Mladost, Bečej	0	100	100	0	2	200	2	
3 IGNJATOVIĆ, Iva UDŽK Kinezis, Niš	1	0	100	0	2	2	3	
4 ŠMIGIĆ, Milica Partizan, Kraljevo	0	0	0	100	0	0	5	
5 MAKSIMOVIĆ, Minja SU Radnički 034, Kragujevac	10	100	100	100	4	310	1	

GNJATOVIĆ, Lena	VOŽ	1	GNJATOVIĆ, Lena
NIKOLIĆ, Marija	MLA	1	Voždovac, Beograd
IGNJATOVIĆ, Iva	KIN	2	IGNJATOVIĆ, Iva
ŠMIGIĆ, Milica	PKR	2	UDŽK Kinezis, Niš
GNJATOVIĆ, Lena	VOŽ	3	MAKSIMOVIĆ, Minja
MAKSIMOVIĆ, Minja	034	3	SU Radnički 034, Kragujevac
NIKOLIĆ, Marija	MLA	4	NIKOLIĆ, Marija
IGNJATOVIĆ, Iva	KIN	4	Mladost, Bečej
ŠMIGIĆ, Milica	PKR	5	MAKSIMOVIĆ, Minja
MAKSIMOVIĆ, Minja	034	5	SU Radnički 034, Kragujevac
GNJATOVIĆ, Lena	VOŽ	6	IGNJATOVIĆ, Iva
IGNJATOVIĆ, Iva	KIN	6	UDŽK Kinezis, Niš
NIKOLIĆ, Marija	MLA	7	NIKOLIĆ, Marija
ŠMIGIĆ, Milica	PKR	7	Mladost, Bečej
IGNJATOVIĆ, Iva	KIN	8	MAKSIMOVIĆ, Minja
MAKSIMOVIĆ, Minja	034	8	SU Radnički 034, Kragujevac
GNJATOVIĆ, Lena	VOŽ	9	GNJATOVIĆ, Lena
ŠMIGIĆ, Milica	PKR	9	Voždovac, Beograd
NIKOLIĆ, Marija	MLA	10	MAKSIMOVIĆ, Minja
MAKSIMOVIĆ, Minja	034	10	SU Radnički 034, Kragujevac

Rezultati

1. MAKSIMOVIĆ, Minja 034
2. NIKOLIĆ, Marija MLA
3. GNJATOVIĆ, Lena VOŽ
3. IGNJATOVIĆ, Iva KIN
5. ŠMIGIĆ, Milica PKR



SOKOBANJA OPEN 2026

Sokobanja, 20.06.2026.

Starije poletarke

+43KG

5 takmičarki

Takmičar i klub	1	2	3	4	5	Pobeda	Bodova	Mesto
1 ANĐELKOVIĆ, Sofija Džudo udruženje Karadorđević, Sokobanja	---	0	0	0	0	0	0	5
2 DEDOVIĆ, Marija Bambi, Požarevac	100	---	100	100	100	4	400	1
3 MILOSAVLJEVIĆ, Magdalena Jagodina, Jagodina	100	0	---	0	0	1	100	3
4 NIKOLIĆ, Minja SU "Ipon 10", Pirot	100	0	100	---	0	2	200	3
5 IVKOVIĆ, Iskra VGSK, Veliko Gradište	100	0	100	100	---	3	300	2

ANĐELKOVIĆ, Sofija	KAR	1	DEDOVIĆ, Marija
DEDOVIĆ, Marija	BAM		Bambi, Požarevac
MILOSAVLJEVIĆ, Magdalena	JAG	2	NIKOLIĆ, Minja
NIKOLIĆ, Minja	I10		SU "Ipon 10", Pirot
ANĐELKOVIĆ, Sofija	KAR	3	IVKOVIĆ, Iskra
IVKOVIĆ, Iskra	VGS		VGSK, Veliko Gradište
DEDOVIĆ, Marija	BAM	4	DEDOVIĆ, Marija
MILOSAVLJEVIĆ, Magdalena	JAG		Bambi, Požarevac
NIKOLIĆ, Minja	I10	5	IVKOVIĆ, Iskra
IVKOVIĆ, Iskra	VGS		VGSK, Veliko Gradište
ANĐELKOVIĆ, Sofija	KAR	6	MILOSAVLJEVIĆ, Magdalena
MILOSAVLJEVIĆ, Magdalena	JAG		Jagodina, Jagodina
DEDOVIĆ, Marija	BAM	7	DEDOVIĆ, Marija
NIKOLIĆ, Minja	I10		Bambi, Požarevac
MILOSAVLJEVIĆ, Magdalena	JAG	8	IVKOVIĆ, Iskra
IVKOVIĆ, Iskra	VGS		VGSK, Veliko Gradište
ANĐELKOVIĆ, Sofija	KAR	9	NIKOLIĆ, Minja
NIKOLIĆ, Minja	I10		SU "Ipon 10", Pirot
DEDOVIĆ, Marija	BAM	10	DEDOVIĆ, Marija
IVKOVIĆ, Iskra	VGS		Bambi, Požarevac

Rezultati

1. DEDOVIĆ, Marija BAM
2. IVKOVIĆ, Iskra VGS
3. NIKOLIĆ, Minja I10
3. MILOSAVLJEVIĆ, Magdalena JAG
5. ANĐELKOVIĆ, Sofija KAR



SOKOBANJA OPEN 2026

Sokobanja, 20.06.2026.

Mlađi dečaci
-30KG
5 takmičara

Takmičar i klub	1	2	3	4	5	Pobeda	Bodova	Mesto
1 JANKOVIĆ, Vojin Jagodina, Jagodina		0	0	0	0	0	0	5
2 OBRADOVIĆ, Saša Zvezdarac, Beograd	100		0	100	0	2	200	2
3 TASIĆ, Mihajlo Partizan Leskovac, Leskovac	100	100		100	1	4	301	1
4 NIKOLIĆ, Uroš UDŽK Kinezis, Niš	100	0	0		100	2	200	3
5 MOJAŠEVIĆ, Pavle Džudo udruženje Karadorđević, Sokobanja	100	100	0	0		2	200	3

JANKOVIĆ, Vojin	JAG	1	OBRADOVIĆ, Saša
OBRADOVIĆ, Saša	ZBG		Zvezdarac, Beograd
TASIĆ, Mihajlo	PLE	2	TASIĆ, Mihajlo
NIKOLIĆ, Uroš	KIN		Partizan Leskovac, Leskovac
JANKOVIĆ, Vojin	JAG	3	MOJAŠEVIĆ, Pavle
MOJAŠEVIĆ, Pavle	KAR		Džudo udruženje Karadorđević, Sokobanja
OBRADOVIĆ, Saša	ZBG	4	TASIĆ, Mihajlo
TASIĆ, Mihajlo	PLE		Partizan Leskovac, Leskovac
NIKOLIĆ, Uroš	KIN	5	NIKOLIĆ, Uroš
MOJAŠEVIĆ, Pavle	KAR		UDŽK Kinezis, Niš
JANKOVIĆ, Vojin	JAG	6	TASIĆ, Mihajlo
TASIĆ, Mihajlo	PLE		Partizan Leskovac, Leskovac
OBRADOVIĆ, Saša	ZBG	7	OBRADOVIĆ, Saša
NIKOLIĆ, Uroš	KIN		Zvezdarac, Beograd
TASIĆ, Mihajlo	PLE	8	TASIĆ, Mihajlo
MOJAŠEVIĆ, Pavle	KAR		Partizan Leskovac, Leskovac
JANKOVIĆ, Vojin	JAG	9	NIKOLIĆ, Uroš
NIKOLIĆ, Uroš	KIN		UDŽK Kinezis, Niš
OBRADOVIĆ, Saša	ZBG	10	MOJAŠEVIĆ, Pavle
MOJAŠEVIĆ, Pavle	KAR		Džudo udruženje Karadorđević, Sokobanja

Rezultati

1. TASIĆ, Mihajlo PLE
2. OBRADOVIĆ, Saša ZBG
3. NIKOLIĆ, Uroš KIN
3. MOJAŠEVIĆ, Pavle KAR
5. JANKOVIĆ, Vojin JAG



SOKOBANJA OPEN 2026

Sokobanja, 20.06.2026.

Mlađi dečaci

-34KG

9 takmičara

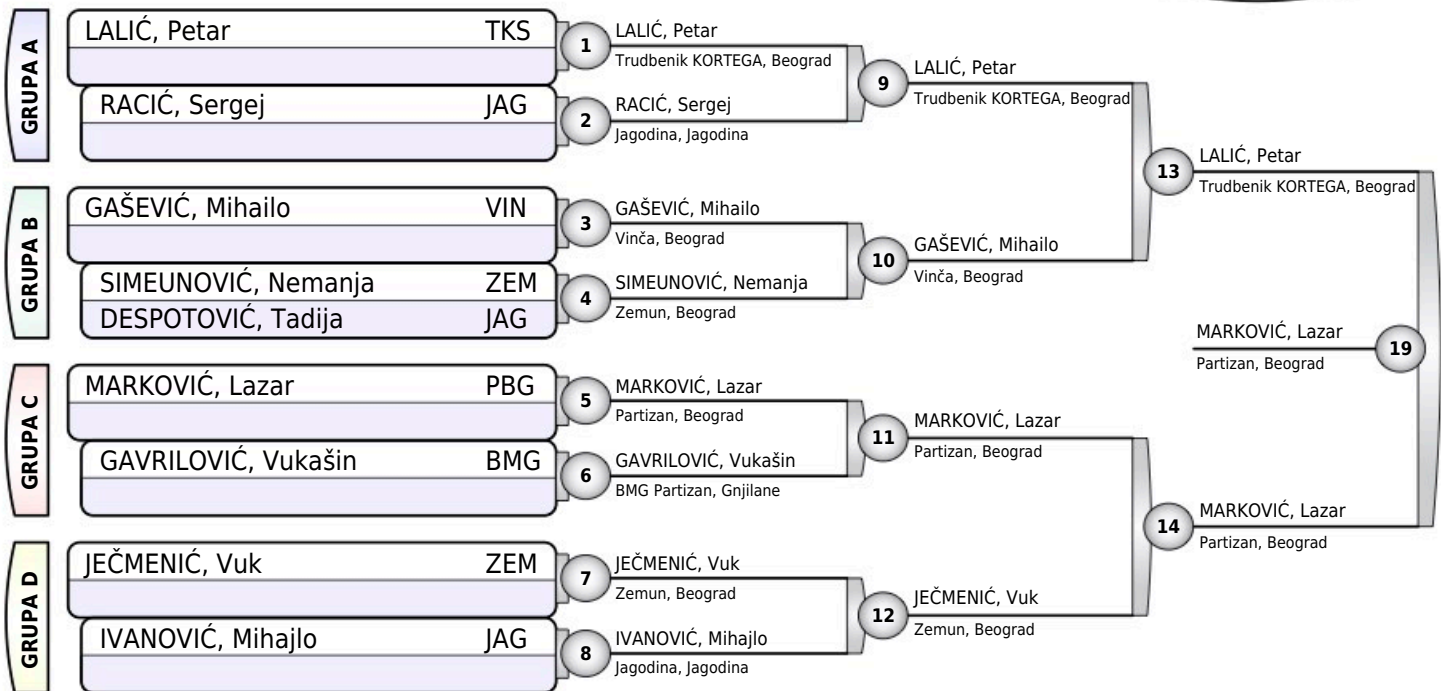

Rezultati

1. MARKOVIĆ, Lazar PBG
2. LALIĆ, Petar TKS
3. GAŠEVIĆ, Mihailo VIN
3. JEČMENIĆ, Vuk ZEM
5. RACIĆ, Sergej JAG
5. GAVRILOVIĆ, Vukašin BMG
- 7.
- 7.

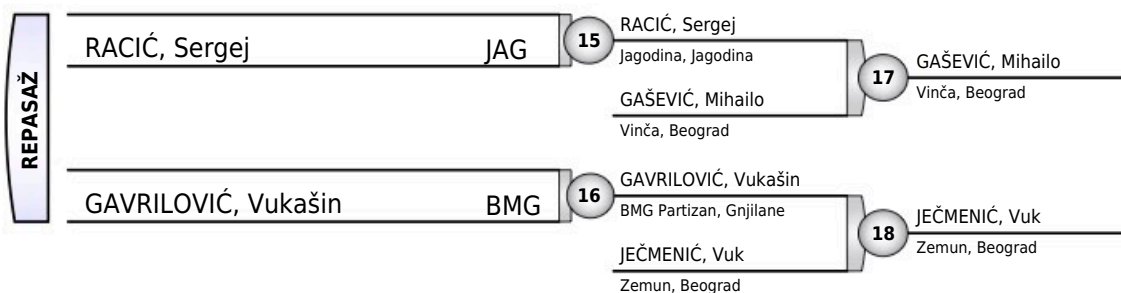



SOKOBANJA OPEN 2026

Sokobanja, 20.06.2026.

Mlađi dečaci
-38KG
14 takmičara

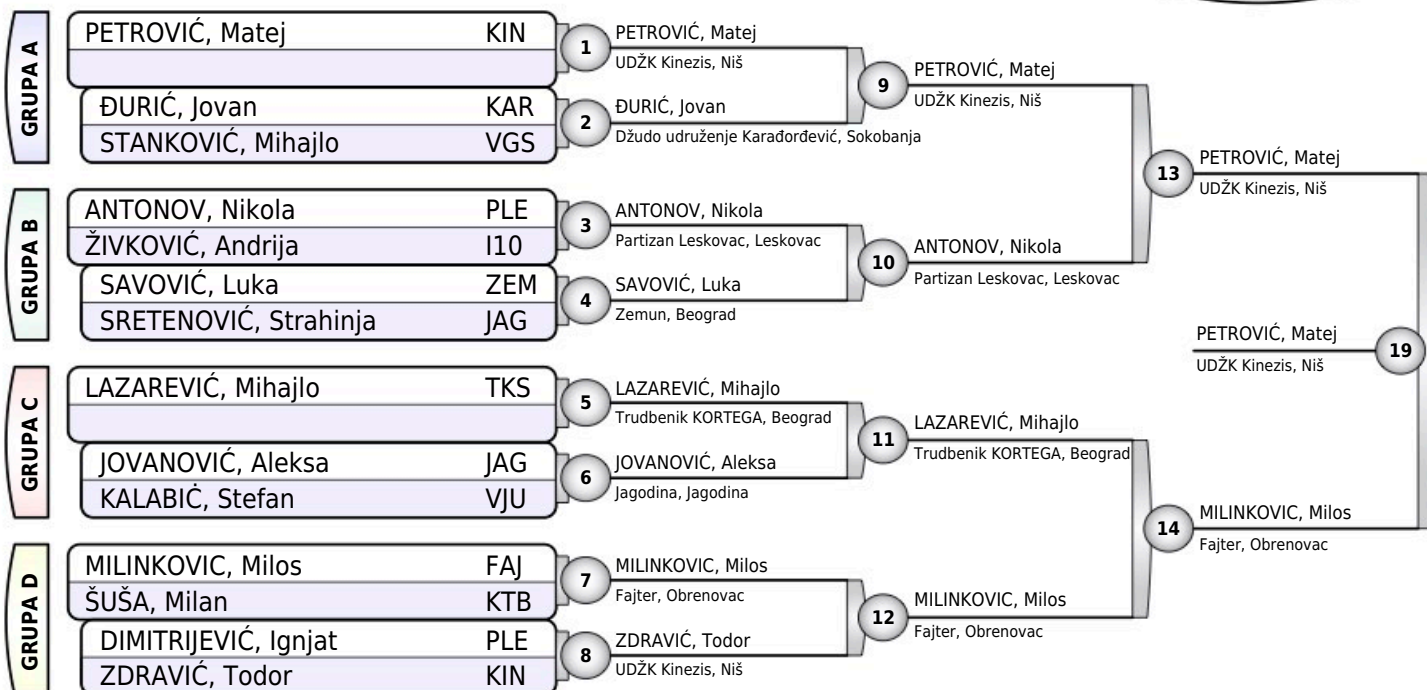

Rezultati

- PETROVIĆ, Matej KIN
- MILINKOVIC, Milos FAJ
- ANTONOV, Nikola PLE
- LAZAREVIĆ, Mihajlo TKS
- ĐURIĆ, Jovan KAR
- ZDRAVIĆ, Todor KIN
- ŠUŠA, Milan KTB
-

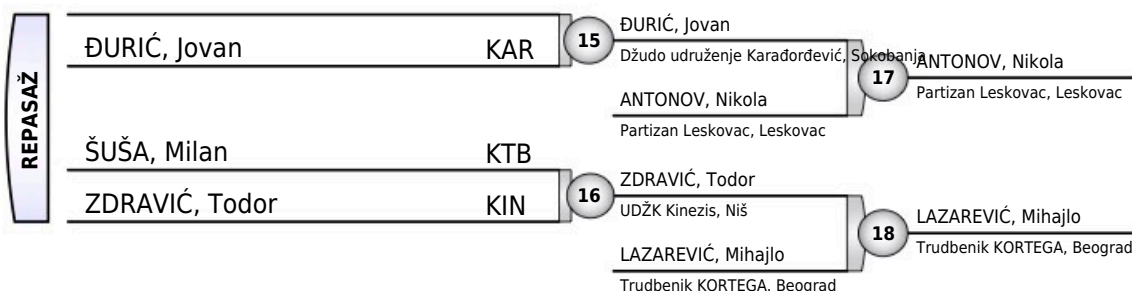



SOKOBANJA OPEN 2026

Sokobanja, 20.06.2026.

Mlađi dečaci

-42KG

14 takmičara

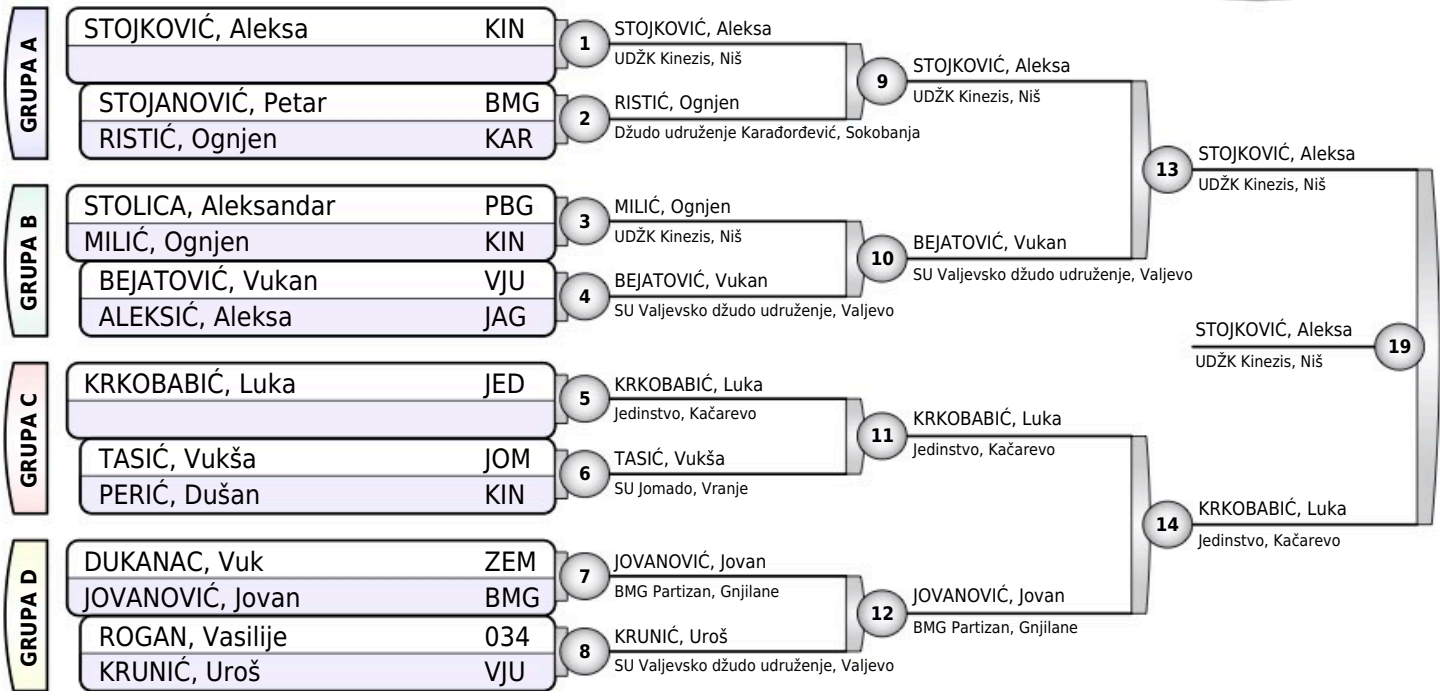

Rezultati

1. STOJKOVIĆ, Aleksa KIN
2. KRKOBABIĆ, Luka JED
3. BEJATOVIĆ, Vukan VJU
3. JOVANOVIĆ, Jovan BMG
5. RISTIĆ, Ognjen KAR
5. TASIĆ, Vukša JOM
- 7.
- 7.

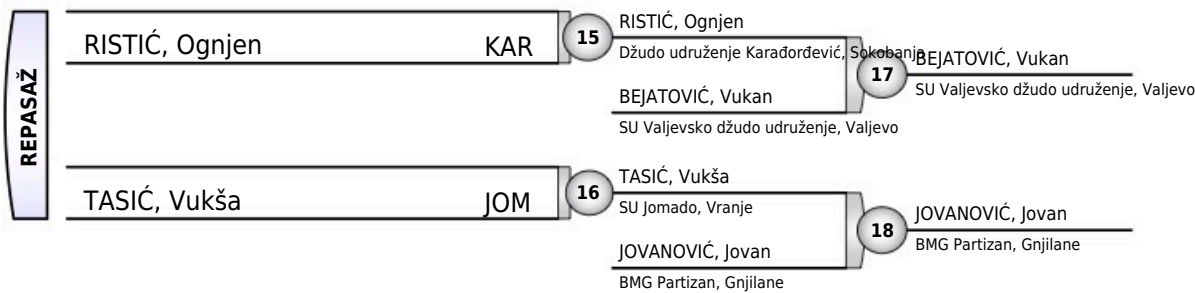



SOKOBANJA OPEN 2026

Sokobanja, 20.06.2026.

Mlađi dečaci

-46KG

9 takmičara

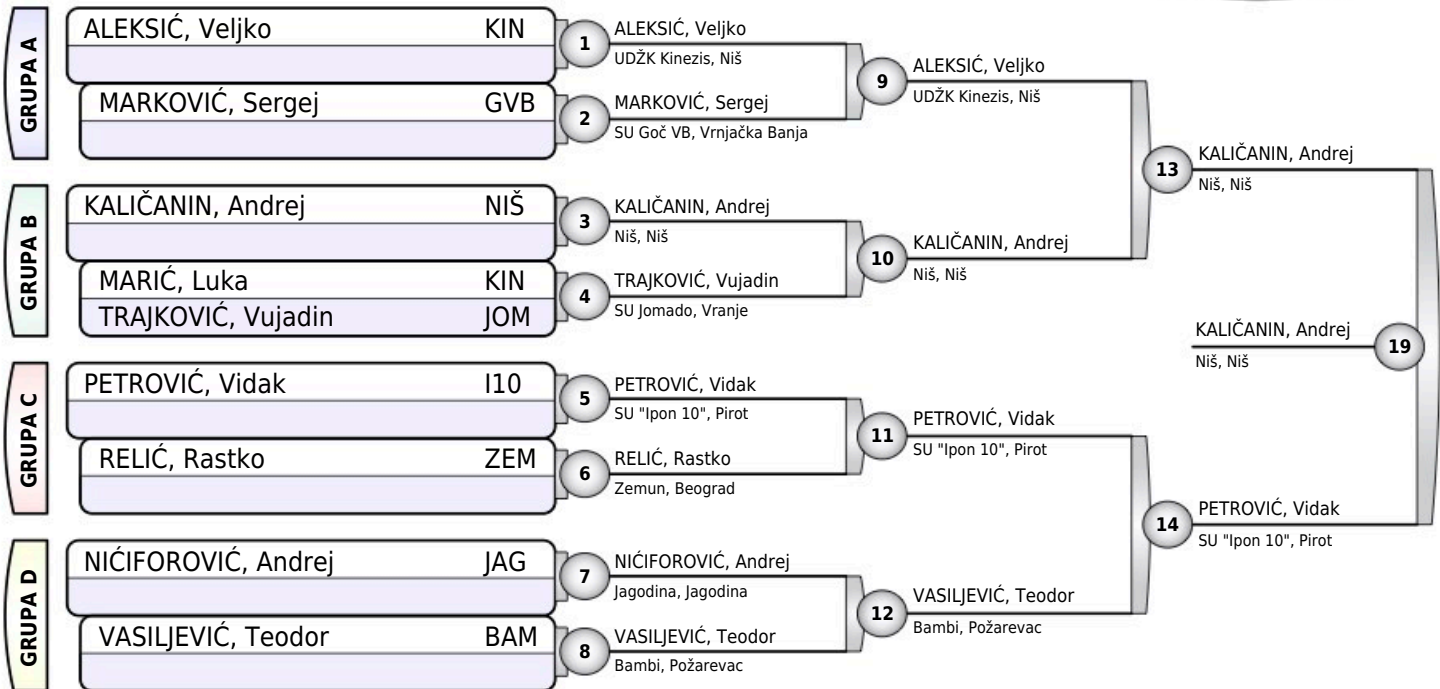

Rezultati

1. KALIČANIN, Andrej NIŠ
2. PETROVIĆ, Vidak I10
3. TRAJKOVIĆ, Vujadin JOM
3. RELIĆ, Rastko ZEM
5. ALEKSIĆ, Veljko KIN
5. VASILJEVIĆ, Teodor BAM
- 7.
- 7.

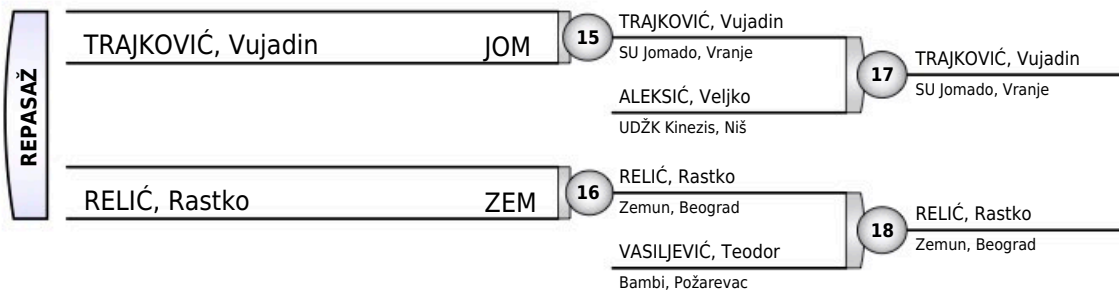



SOKOBANJA OPEN 2026

Sokobanja, 20.06.2026.

Mlađi dečaci
-50KG
10 takmičara

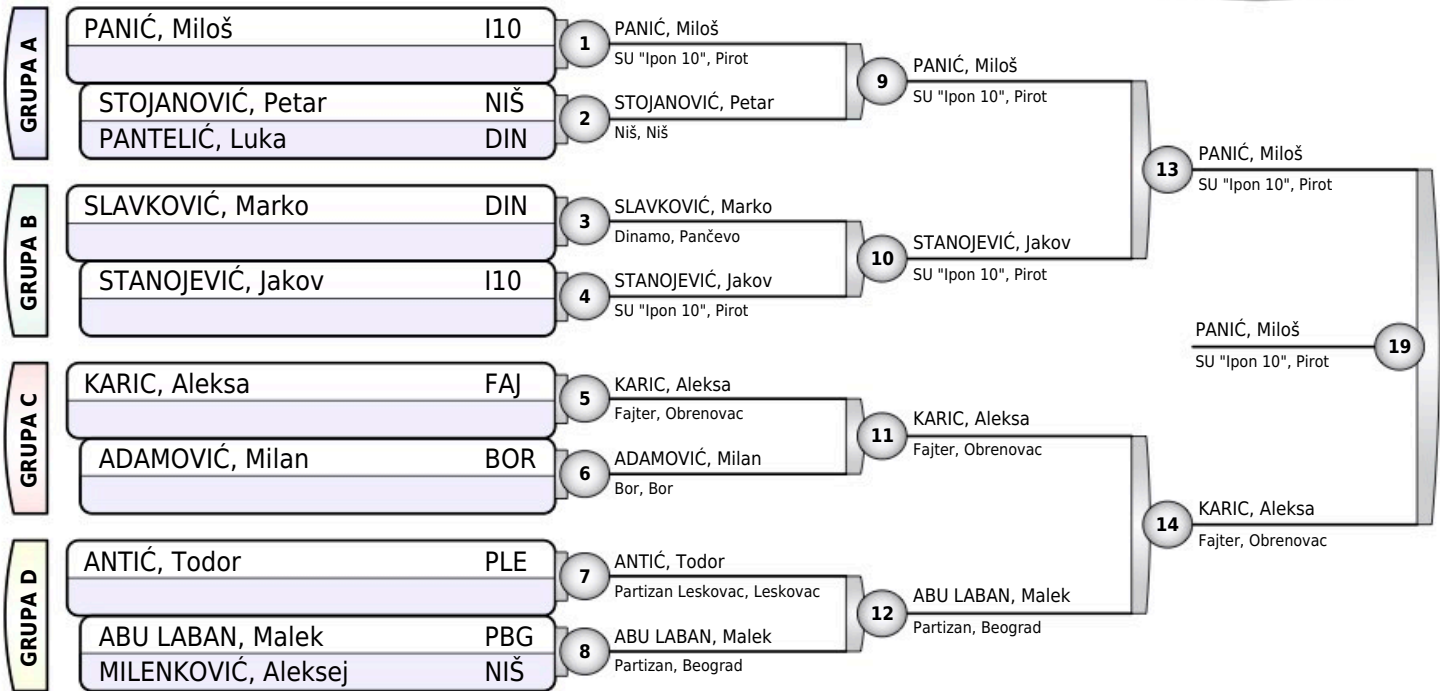

Rezultati

1. PANIĆ, Miloš I10
2. KARIC, Aleksa FAJ
3. STANOJEVIĆ, Jakov I10
3. ABU LABAN, Malek PBG
5. STOJANOVIĆ, Petar NIŠ
5. ADAMOVIĆ, Milan BOR
- 7.
- 7.



SOKOBANJA OPEN 2026

Sokobanja, 20.06.2026.

Mlađi dečaci
-55KG
10 takmičara

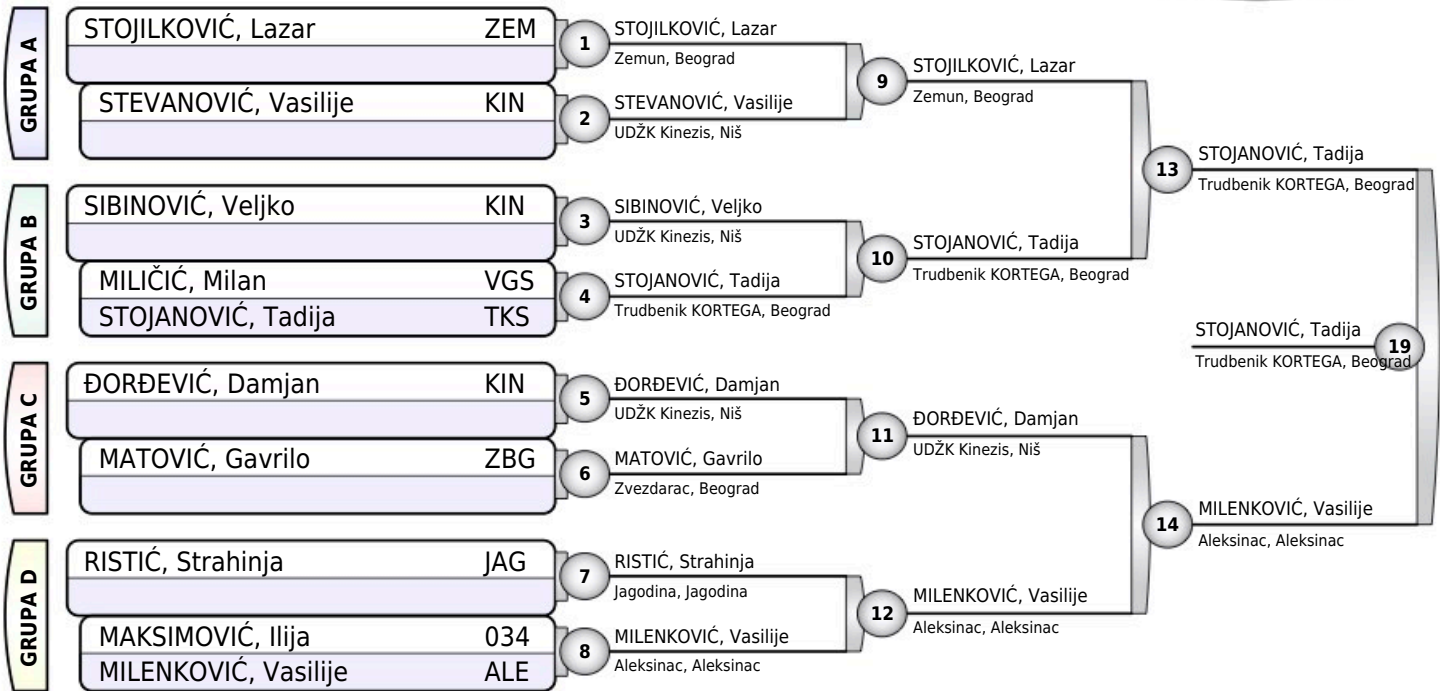

Rezultati

1. STOJANOVIĆ, Tadija TKS
2. MILENKOVIĆ, Vasilije ALE
3. STOJILKOVIĆ, Lazar ZEM
3. ĐORĐEVIĆ, Damjan KIN
5. SIBINOVIĆ, Veljko KIN
5. RISTIĆ, Strahinja JAG
7. MILIČIĆ, Milan VGS
7. MAKSIMOVIĆ, Ilija 034

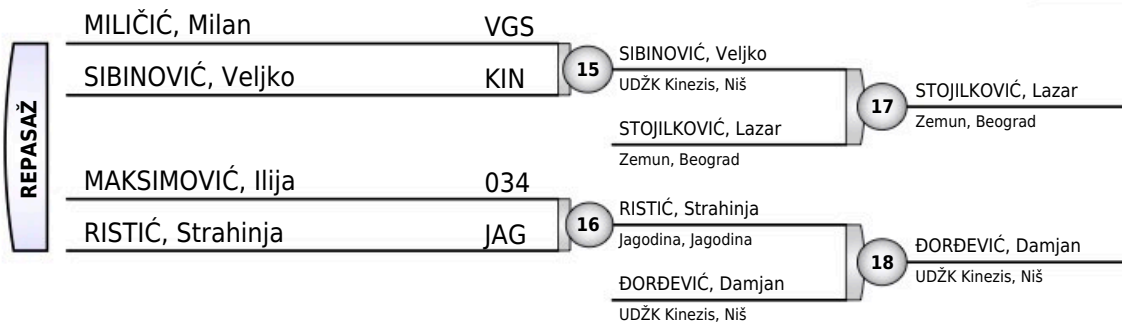



SOKOBANJA OPEN 2026

Sokobanja, 20.06.2026.

Mlađi dečaci

-60KG

6 takmičara

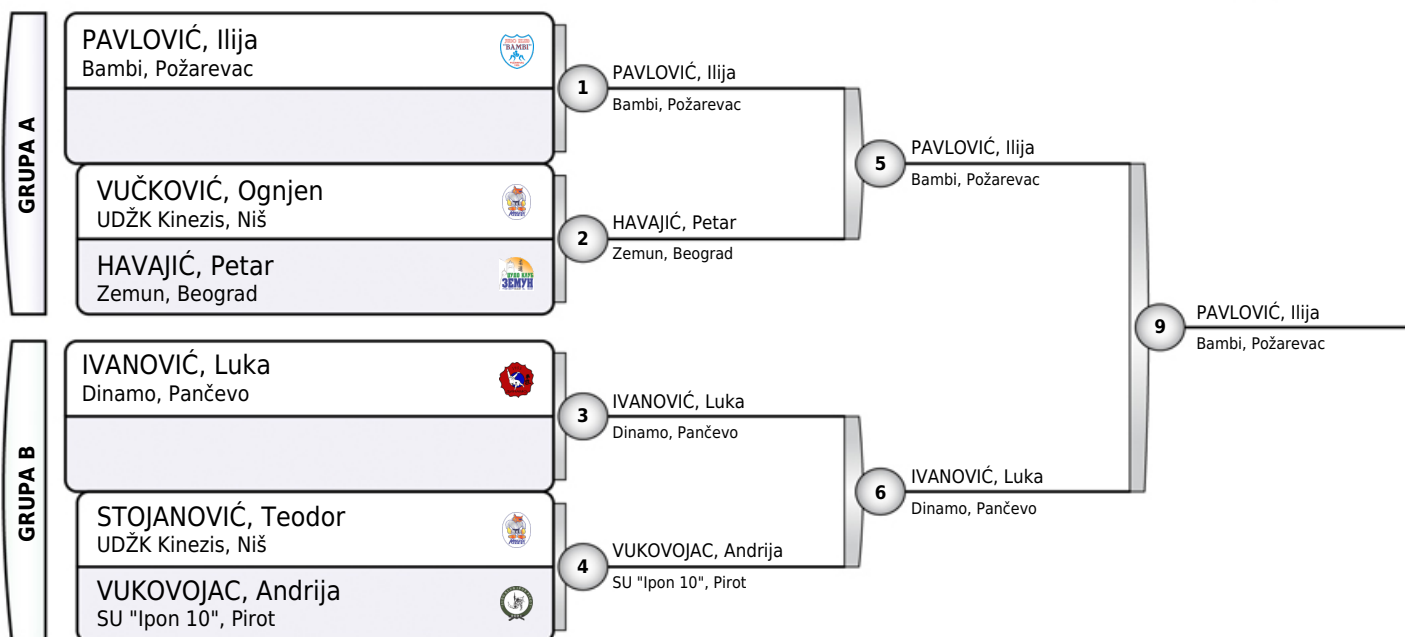

Rezultati

1. PAVLOVIĆ, Ilija BAM
2. IVANOVIĆ, Luka DIN
3. HAVAJIĆ, Petar ZEM
3. VUKOVOJAC, Andrija I10
- 5.
- 5.
- 7.
- 7.

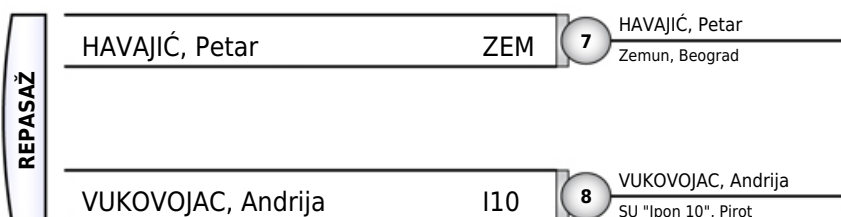



SOKOBANJA OPEN 2026

Sokobanja, 20.06.2026.

Mlađi dečaci
-66KG
5 takmičara

Takmičar i klub	1	2	3	4	5	Pobeda	Bodova	Mesto
1 PETKOVIĆ, Petar Akademija Todorović, Zaječar		0	0	0	0	0	0	5
2 PANTELIĆ, Sava UDŽK Kinezis, Niš	100		1	100	0	3	201	2
3 STEFANOVIĆ, Ognjen Trudbenik KORTEGA, Beograd	100	0		100	0	2	200	3
4 ĐORĐEVIĆ, Mihajlo Župa Aleksandrovac, Aleksandrovac	100	0	0		0	1	100	3
5 TRUMIĆ, Žika Voždovac, Beograd	100	1	10	100		4	211	1

PETKOVIĆ, Petar	AKT	1	PANTELIĆ, Sava
PANTELIĆ, Sava	KIN		UDŽK Kinezis, Niš
STEFANOVIĆ, Ognjen	TKS	2	STEFANOVIĆ, Ognjen
ĐORĐEVIĆ, Mihajlo	ŽAL		Trudbenik KORTEGA, Beograd
PETKOVIĆ, Petar	AKT	3	TRUMIĆ, Žika
TRUMIĆ, Žika	VOŽ		Voždovac, Beograd
PANTELIĆ, Sava	KIN	4	PANTELIĆ, Sava
STEFANOVIĆ, Ognjen	TKS		UDŽK Kinezis, Niš
ĐORĐEVIĆ, Mihajlo	ŽAL	5	TRUMIĆ, Žika
TRUMIĆ, Žika	VOŽ		Voždovac, Beograd
PETKOVIĆ, Petar	AKT	6	STEFANOVIĆ, Ognjen
STEFANOVIĆ, Ognjen	TKS		Trudbenik KORTEGA, Beograd
PANTELIĆ, Sava	KIN	7	PANTELIĆ, Sava
ĐORĐEVIĆ, Mihajlo	ŽAL		UDŽK Kinezis, Niš
STEFANOVIĆ, Ognjen	TKS	8	TRUMIĆ, Žika
TRUMIĆ, Žika	VOŽ		Voždovac, Beograd
PETKOVIĆ, Petar	AKT	9	ĐORĐEVIĆ, Mihajlo
ĐORĐEVIĆ, Mihajlo	ŽAL		Župa Aleksandrovac, Aleksandrovac
PANTELIĆ, Sava	KIN	10	TRUMIĆ, Žika
TRUMIĆ, Žika	VOŽ		Voždovac, Beograd

Rezultati

1. TRUMIĆ, Žika VOŽ
2. PANTELIĆ, Sava KIN
3. STEFANOVIĆ, Ognjen TKS
3. ĐORĐEVIĆ, Mihajlo ŽAL
5. PETKOVIĆ, Petar AKT



SOKOBANJA OPEN 2026

Sokobanja, 20.06.2026.

Mlađi dečaci

+66KG

5 takmičara

Takmičar i klub	1	2	3	4	5	Pobeda	Bodova	Mesto
1 GRUJIĆ, Dimitrije Džudo udruženje Karađorđević, Sokobanja		0	0	0	0	0	0	5
2 ZEČEVIĆ, Aleksa Vinča, Beograd	100		100	100	100	4	400	1
3 PANTIĆ, Veljko Jagodina, Jagodina	100	0		100	0	2	200	3
4 ĐORĐEVIĆ, Nikola VGSK, Veliko Gradište	100	0	0		0	1	100	3
5 SPASOJEVIĆ, Ognjen SU Valjevsko džudo udruženje, Valjevo	100	0	100	100		3	300	2

GRUJIĆ, Dimitrije	KAR	1	ZEČEVIĆ, Aleksa
ZEČEVIĆ, Aleksa	VIN		Vinča, Beograd
PANTIĆ, Veljko	JAG	2	PANTIĆ, Veljko
ĐORĐEVIĆ, Nikola	VGS		Jagodina, Jagodina
GRUJIĆ, Dimitrije	KAR	3	SPASOJEVIĆ, Ognjen
SPASOJEVIĆ, Ognjen	VJU		SU Valjevsko džudo udruženje, Valjevo
ZEČEVIĆ, Aleksa	VIN	4	ZEČEVIĆ, Aleksa
PANTIĆ, Veljko	JAG		Vinča, Beograd
ĐORĐEVIĆ, Nikola	VGS	5	SPASOJEVIĆ, Ognjen
SPASOJEVIĆ, Ognjen	VJU		SU Valjevsko džudo udruženje, Valjevo
GRUJIĆ, Dimitrije	KAR	6	PANTIĆ, Veljko
PANTIĆ, Veljko	JAG		Jagodina, Jagodina
ZEČEVIĆ, Aleksa	VIN	7	ZEČEVIĆ, Aleksa
ĐORĐEVIĆ, Nikola	VGS		Vinča, Beograd
PANTIĆ, Veljko	JAG	8	SPASOJEVIĆ, Ognjen
SPASOJEVIĆ, Ognjen	VJU		SU Valjevsko džudo udruženje, Valjevo
GRUJIĆ, Dimitrije	KAR	9	ĐORĐEVIĆ, Nikola
ĐORĐEVIĆ, Nikola	VGS		VGSK, Veliko Gradište
ZEČEVIĆ, Aleksa	VIN	10	ZEČEVIĆ, Aleksa
SPASOJEVIĆ, Ognjen	VJU		Vinča, Beograd

Rezultati

1. ZEČEVIĆ, Aleksa VIN
2. SPASOJEVIĆ, Ognjen VJU
3. PANTIĆ, Veljko JAG
3. ĐORĐEVIĆ, Nikola VGS
5. GRUJIĆ, Dimitrije KAR



SOKOBANJA OPEN 2026

Sokobanja, 20.06.2026.

Mlađe devojčice

-32KG

8 takmičarki

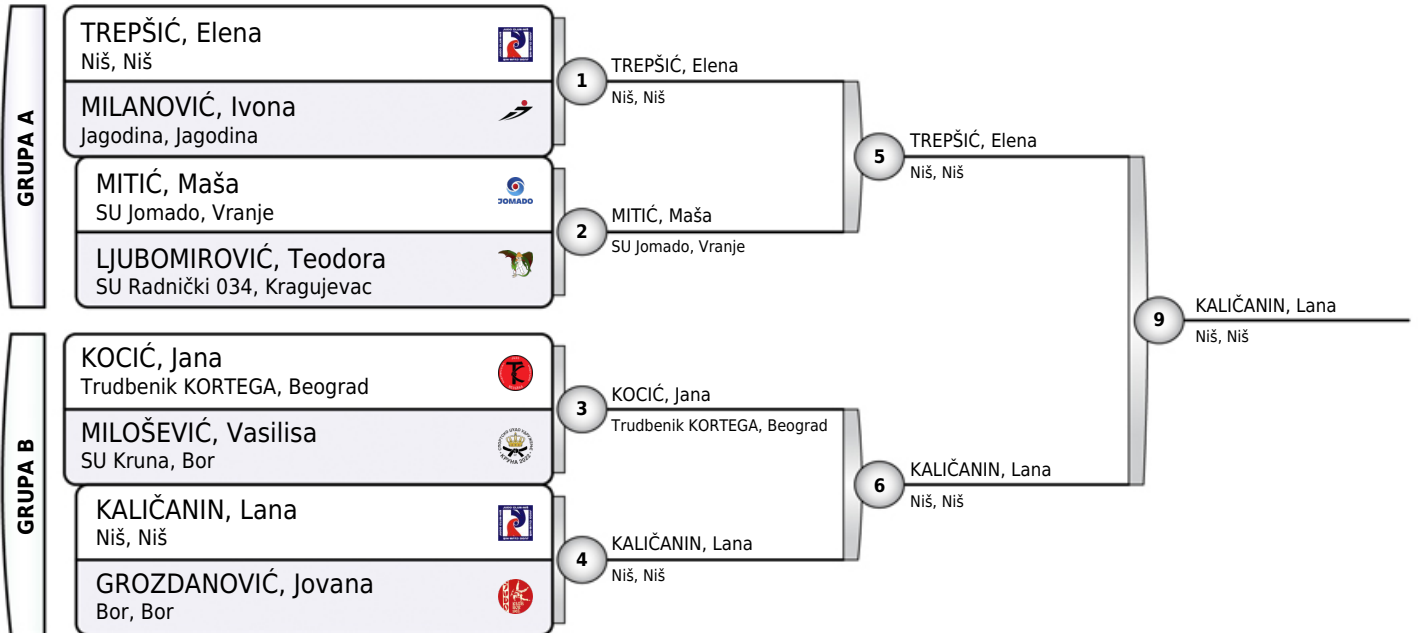

Rezultati

- | | | |
|----|---------------------|-----|
| 1. | KALIČANIN, Lana | NIŠ |
| 2. | TREPŠIĆ, Elena | NIŠ |
| 3. | MITIĆ, Maša | JOM |
| 3. | KOCIĆ, Jana | TKS |
| 5. | MILANOVIĆ, Ivona | JAG |
| 5. | GROZDANOVIĆ, Jovana | BOR |
| 7. | | |
| 7. | | |

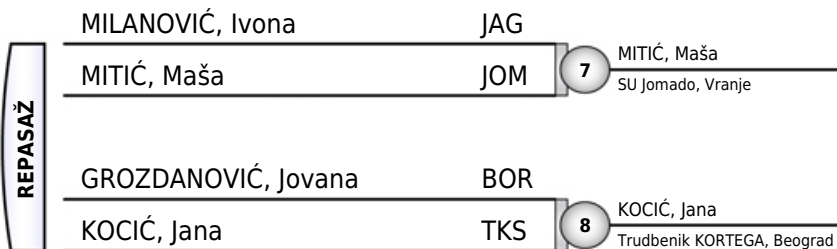



SOKOBANJA OPEN 2026

Sokobanja, 20.06.2026.

Mlađe devojčice

-36KG

5 takmičarki

Takmičar i klub	1	2	3	4	5	Pobeda	Bodova	Mesto
1 KORIBANKOVA, Nikol Arena Sport, Plovdiv		0	100	10	100	3	210	2
2 ANDREJEVIĆ, Tara Džudo udruženje Karađorđević, Sokobanja	100		100	100	100	4	400	1
3 STOJADINOVIĆ, Ilijana Džudo udruženje Karađorđević, Sokobanja	0	0		1	100	2	101	3
4 KOSTIĆ, Hana SU Jomado, Vranje	0	0	0		100	1	100	3
5 KRSTIĆ, Maša SU "Ipon 10", Pirot	0	0	0	0		0	0	5

KORIBANKOVA, Nikol	ARE	1	ANDREJEVIĆ, Tara
ANDREJEVIĆ, Tara	KAR		Džudo udruženje Karađorđević, Sokobanja
STOJADINOVIĆ, Ilijana	KAR	2	STOJADINOVIĆ, Ilijana
KOSTIĆ, Hana	JOM		Džudo udruženje Karađorđević, Sokobanja
KORIBANKOVA, Nikol	ARE	3	KORIBANKOVA, Nikol
KRSTIĆ, Maša	I10		Arena Sport, Plovdiv
ANDREJEVIĆ, Tara	KAR	4	ANDREJEVIĆ, Tara
STOJADINOVIĆ, Ilijana	KAR		Džudo udruženje Karađorđević, Sokobanja
KOSTIĆ, Hana	JOM	5	KOSTIĆ, Hana
KRSTIĆ, Maša	I10		SU Jomado, Vranje
KORIBANKOVA, Nikol	ARE	6	KORIBANKOVA, Nikol
STOJADINOVIĆ, Ilijana	KAR		Arena Sport, Plovdiv
ANDREJEVIĆ, Tara	KAR	7	ANDREJEVIĆ, Tara
KOSTIĆ, Hana	JOM		Džudo udruženje Karađorđević, Sokobanja
STOJADINOVIĆ, Ilijana	KAR	8	STOJADINOVIĆ, Ilijana
KRSTIĆ, Maša	I10		Džudo udruženje Karađorđević, Sokobanja
KORIBANKOVA, Nikol	ARE	9	KORIBANKOVA, Nikol
KOSTIĆ, Hana	JOM		Arena Sport, Plovdiv
ANDREJEVIĆ, Tara	KAR	10	ANDREJEVIĆ, Tara
KRSTIĆ, Maša	I10		Džudo udruženje Karađorđević, Sokobanja

Rezultati

1. ANDREJEVIĆ, Tara KAR
2. KORIBANKOVA, Nikol ARE
3. STOJADINOVIĆ, Ilijana KAR
3. KOSTIĆ, Hana JOM
5. KRSTIĆ, Maša I10



SOKOBANJA OPEN 2026

Sokobanja, 20.06.2026.

Mlađe devojčice

-40KG

7 takmičarki

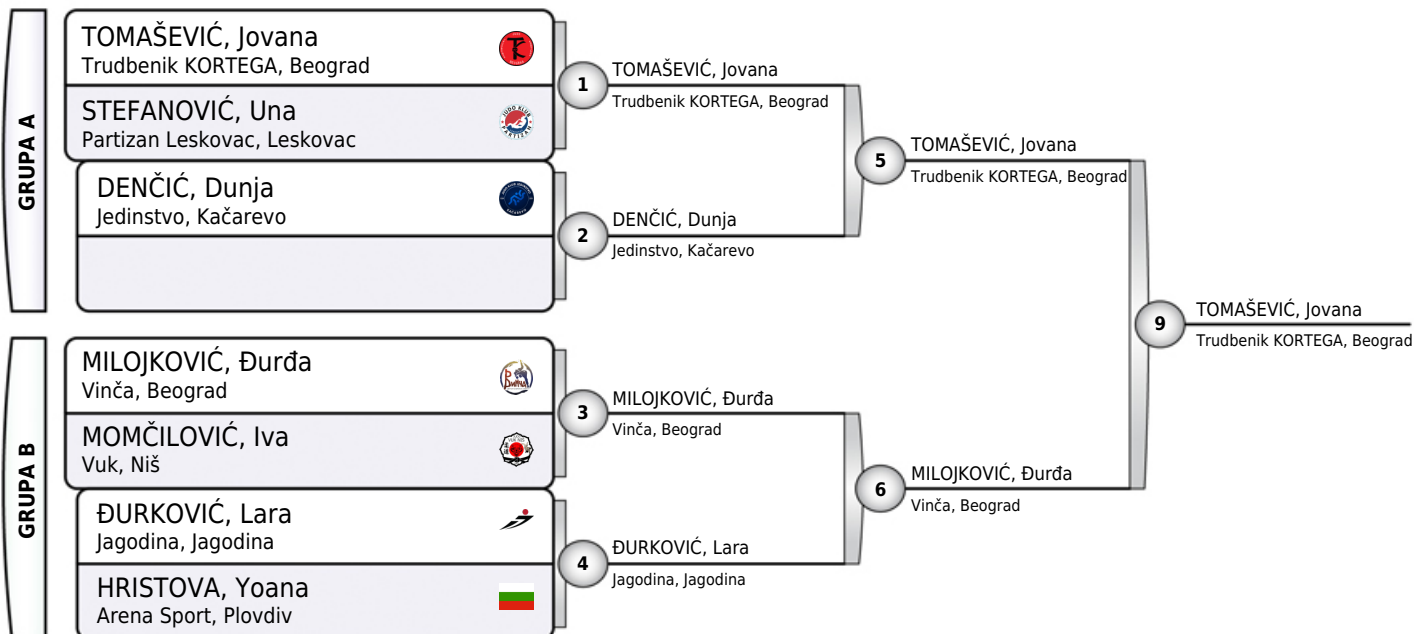

Rezultati

1. TOMAŠEVIĆ, Jovana TKS
2. MILOJKOVIĆ, Đurđa VIN
3. DENČIĆ, Dunja JED
3. ĐURKOVIĆ, Lara JAG
5. STEFANOVIĆ, Una PLE
5. MOMČILOVIĆ, Iva VUK
- 7.
- 7.

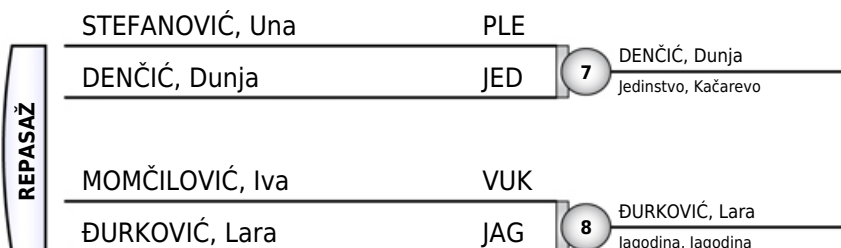



SOKOBANJA OPEN 2026

Sokobanja, 20.06.2026.

Mlađe devojčice

-44KG

4 takmičarke

Takmičar i klub	1	2	3	4	Pobeda	Bodova	Mesto
1 LJUBISAVLJEVIĆ, Luna Partizan Leskovac, Leskovac		0	100	100	2	200	2
2 ANTIĆ, Nikolina Partizan Leskovac, Leskovac	100		100	100	3	300	1
3 MILUTINOVIĆ, Neda Džudo udruženje Karađorđević, Sokobanja	0	0		100	1	100	3
4 BOŽILOVIĆ, Andrea SU "Ipon 10", Piro	0	0	0		0	0	3

LJUBISAVLJEVIĆ, Luna	PLE	1	ANTIĆ, Nikolina
ANTIĆ, Nikolina	PLE		Partizan Leskovac, Leskovac
MILUTINOVIĆ, Neda	KAR	2	MILUTINOVIĆ, Neda
BOŽILOVIĆ, Andrea	I10		Džudo udruženje Karađorđević, Sokobanja
LJUBISAVLJEVIĆ, Luna	PLE	3	LJUBISAVLJEVIĆ, Luna
MILUTINOVIĆ, Neda	KAR		Partizan Leskovac, Leskovac
ANTIĆ, Nikolina	PLE	4	ANTIĆ, Nikolina
BOŽILOVIĆ, Andrea	I10		Partizan Leskovac, Leskovac
LJUBISAVLJEVIĆ, Luna	PLE	5	LJUBISAVLJEVIĆ, Luna
BOŽILOVIĆ, Andrea	I10		Partizan Leskovac, Leskovac
ANTIĆ, Nikolina	PLE	6	ANTIĆ, Nikolina
MILUTINOVIĆ, Neda	KAR		Partizan Leskovac, Leskovac

Rezultati

1. ANTIĆ, Nikolina PLE
2. LJUBISAVLJEVIĆ, Luna PLE
3. MILUTINOVIĆ, Neda KAR
3. BOŽILOVIĆ, Andrea I10



SOKOBANJA OPEN 2026

Sokobanja, 20.06.2026.

Mlađe devojčice

-48KG

4 takmičarke

Takmičar i klub	1	2	3	4	Pobeda	Bodova	Mesto
1 JOCOVIĆ, Nina SU Radnički 034, Kragujevac		0	0	0	0	0	3
2 ZLATKOVIĆ, Daša Partizan Leskovac, Leskovac	100		1	100	3	201	1
3 NIKOLIĆ, Gorica Vinča, Beograd	100	0		100	2	200	2
4 ĐOĐEVIĆ, Leontina BMG Partizan, Gnjilane	100	0	0		1	100	3

JOCOVIĆ, Nina	034	1	ZLATKOVIĆ, Daša
ZLATKOVIĆ, Daša	PLE		Partizan Leskovac, Leskovac
NIKOLIĆ, Gorica	VIN	2	NIKOLIĆ, Gorica
ĐOĐEVIĆ, Leontina	BMG		Vinča, Beograd
JOCOVIĆ, Nina	034	3	NIKOLIĆ, Gorica
NIKOLIĆ, Gorica	VIN		Vinča, Beograd
ZLATKOVIĆ, Daša	PLE	4	ZLATKOVIĆ, Daša
ĐOĐEVIĆ, Leontina	BMG		Partizan Leskovac, Leskovac
JOCOVIĆ, Nina	034	5	ĐOĐEVIĆ, Leontina
ĐOĐEVIĆ, Leontina	BMG		BMG Partizan, Gnjilane
ZLATKOVIĆ, Daša	PLE	6	ZLATKOVIĆ, Daša
NIKOLIĆ, Gorica	VIN		Partizan Leskovac, Leskovac

Rezultati

1. ZLATKOVIĆ, Daša PLE
2. NIKOLIĆ, Gorica VIN
3. ĐOĐEVIĆ, Leontina BMG
3. JOCOVIĆ, Nina 034



SOKOBANJA OPEN 2026

Sokobanja, 20.06.2026.

Mlađe devojčice

-52KG

4 takmičarke

Takmičar i klub	1	2	3	4	Pobeda	Bodova	Mesto
1 SAVIĆ, Jovana Vuk, Niš		0	0	100	1	100	3
2 MATOVIĆ, Marija Mašinac, Kraljevo	100		0	100	2	200	2
3 GNJATOVIĆ, Ana Voždovac, Beograd	100	100		100	3	300	1
4 MINIĆ, Luna SU "Ipon 10", Pirot	0	0	0		0	0	3

SAVIĆ, Jovana	VUK	1	MATOVIĆ, Marija
MATOVIĆ, Marija	MAŠ		Mašinac, Kraljevo
GNJATOVIĆ, Ana	VOŽ	2	GNJATOVIĆ, Ana
MINIĆ, Luna	I10		Voždovac, Beograd
SAVIĆ, Jovana	VUK	3	GNJATOVIĆ, Ana
GNJATOVIĆ, Ana	VOŽ		Voždovac, Beograd
MATOVIĆ, Marija	MAŠ	4	MATOVIĆ, Marija
MINIĆ, Luna	I10		Mašinac, Kraljevo
SAVIĆ, Jovana	VUK	5	SAVIĆ, Jovana
MINIĆ, Luna	I10		Vuk, Niš
MATOVIĆ, Marija	MAŠ	6	GNJATOVIĆ, Ana
GNJATOVIĆ, Ana	VOŽ		Voždovac, Beograd

Rezultati

- GNJATOVIĆ, Ana VOŽ
- MATOVIĆ, Marija MAŠ
- SAVIĆ, Jovana VUK
- MINIĆ, Luna I10



SOKOBANJA OPEN 2026

Sokobanja, 20.06.2026.

Mlađe devojčice

-56KG

4 takmičarke

Takmičar i klub	1	2	3	4	Pobeda	Bodova	Mesto
1 STOJANOVIĆ, Helena Džudo udruženje Karađorđević, Sokobanja		0	0	100	1	100	3
2 FILIPOVIĆ, Una Partizan Leskovac, Leskovac	100		100	100	3	300	1
3 PREKOVIĆ, Agnija SU Radnički 034, Kragujevac	100	0		100	2	200	2
4 PETKOVIĆ, Marija Džudo udruženje Karađorđević, Sokobanja	0	0	0		0	0	3

STOJANOVIĆ, Helena	KAR	1	FILIPOVIĆ, Una
FILIPOVIĆ, Una	PLE		Partizan Leskovac, Leskovac
PREKOVIĆ, Agnija	034	2	PREKOVIĆ, Agnija
PETKOVIĆ, Marija	KAR		SU Radnički 034, Kragujevac
STOJANOVIĆ, Helena	KAR	3	PREKOVIĆ, Agnija
PREKOVIĆ, Agnija	034		SU Radnički 034, Kragujevac
FILIPOVIĆ, Una	PLE	4	FILIPOVIĆ, Una
PETKOVIĆ, Marija	KAR		Partizan Leskovac, Leskovac
STOJANOVIĆ, Helena	KAR	5	STOJANOVIĆ, Helena
PETKOVIĆ, Marija	KAR		Džudo udruženje Karađorđević, Sokobanja
FILIPOVIĆ, Una	PLE	6	FILIPOVIĆ, Una
PREKOVIĆ, Agnija	034		Partizan Leskovac, Leskovac

Rezultati

1. FILIPOVIĆ, Una PLE
2. PREKOVIĆ, Agnija 034
3. STOJANOVIĆ, Helena KAR
3. PETKOVIĆ, Marija KAR



SOKOBANJA OPEN 2026

Sokobanja, 20.06.2026.

Mlađe devojčice

+56KG

5 takmičarki

Takmičar i klub	1	2	3	4	5	Pobeda	Bodova	Mesto
1 ĐEKIĆ, Sara BMG Partizan, Gnjilane	---	0	0	100	0	1	100	3
2 RISTIVOJEVIĆ, Maja SU Valjevsko džudo udruženje, Valjevo	100	---	10	100	100	4	310	1
3 RUSIMOVIĆ, Dunja Aleksinac, Aleksinac	100	0	---	100	100	3	300	2
4 STOJANOVIĆ, Lana Džudo udruženje Karadorđević, Sokobanja	0	0	0	---	0	0	0	5
5 JOKSIMOVIĆ, Helena Fajter, Obrenovac	100	0	0	10	---	2	110	3

ĐEKIĆ, Sara	BMG	1	RISTIVOJEVIĆ, Maja
RISTIVOJEVIĆ, Maja	VJU		SU Valjevsko džudo udruženje, Valjevo
RUSIMOVIĆ, Dunja	ALE	2	RUSIMOVIĆ, Dunja
STOJANOVIĆ, Lana	KAR		Aleksinac, Aleksinac
ĐEKIĆ, Sara	BMG	3	JOKSIMOVIĆ, Helena
JOKSIMOVIĆ, Helena	FAJ		Fajter, Obrenovac
RISTIVOJEVIĆ, Maja	VJU	4	RISTIVOJEVIĆ, Maja
RUSIMOVIĆ, Dunja	ALE		SU Valjevsko džudo udruženje, Valjevo
STOJANOVIĆ, Lana	KAR	5	JOKSIMOVIĆ, Helena
JOKSIMOVIĆ, Helena	FAJ		Fajter, Obrenovac
ĐEKIĆ, Sara	BMG	6	RUSIMOVIĆ, Dunja
RUSIMOVIĆ, Dunja	ALE		Aleksinac, Aleksinac
RISTIVOJEVIĆ, Maja	VJU	7	RISTIVOJEVIĆ, Maja
STOJANOVIĆ, Lana	KAR		SU Valjevsko džudo udruženje, Valjevo
RUSIMOVIĆ, Dunja	ALE	8	RUSIMOVIĆ, Dunja
JOKSIMOVIĆ, Helena	FAJ		Aleksinac, Aleksinac
ĐEKIĆ, Sara	BMG	9	ĐEKIĆ, Sara
STOJANOVIĆ, Lana	KAR		BMG Partizan, Gnjilane
RISTIVOJEVIĆ, Maja	VJU	10	RISTIVOJEVIĆ, Maja
JOKSIMOVIĆ, Helena	FAJ		SU Valjevsko džudo udruženje, Valjevo

Rezultati

1. RISTIVOJEVIĆ, Maja VJU
2. RUSIMOVIĆ, Dunja ALE
3. JOKSIMOVIĆ, Helena FAJ
3. ĐEKIĆ, Sara BMG
5. STOJANOVIĆ, Lana KAR



SOKOBANJA OPEN 2026

Sokobanja, 20.06.2026.

Stariji dečaci
-38KG
6 takmičara

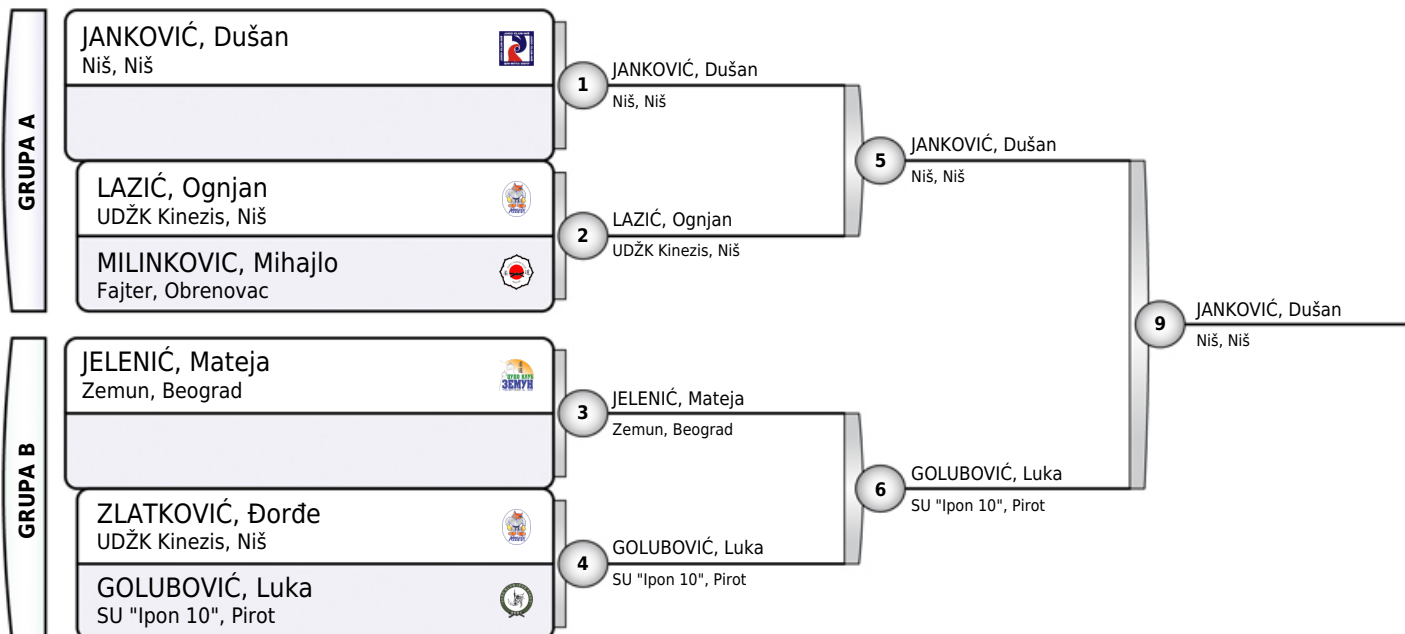

Rezultati

1. JANKOVIĆ, Dušan NIŠ
2. GOLUBOVIĆ, Luka I10
3. LAZIĆ, Ognjan KIN
3. JELENIĆ, Mateja ZEM
5. ZLATKOVIĆ, Đorđe KIN
- 5.
- 7.
- 7.

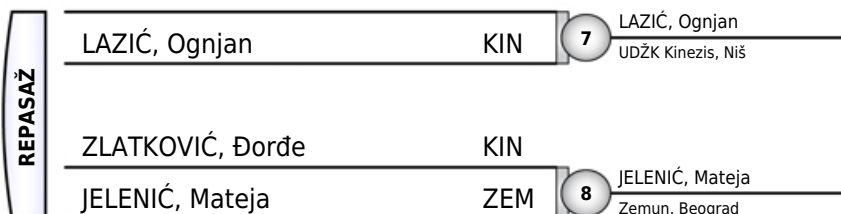



SOKOBANJA OPEN 2026

Sokobanja, 20.06.2026.

Stariji dečaci

-42KG

6 takmičara

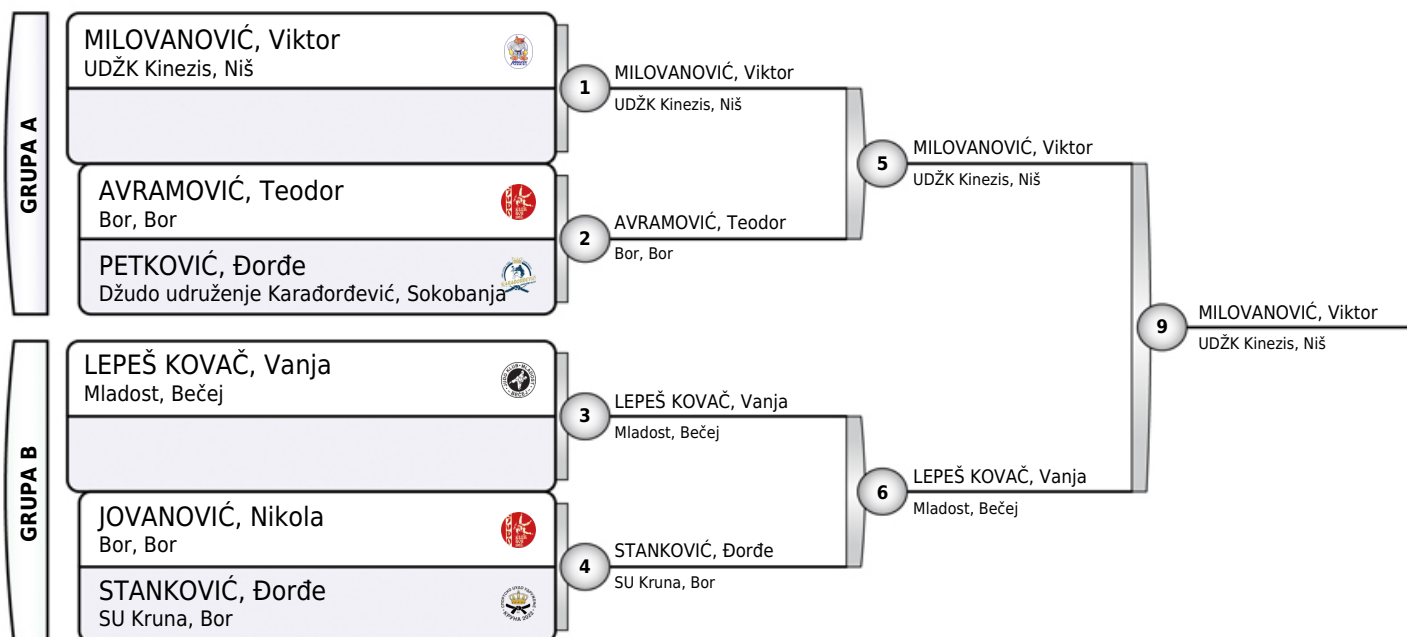

Rezultati

1. MILOVANOVIĆ, Viktor KIN
2. LEPEŠ KOVAČ, Vanja MLA
3. AVRAMOVIĆ, Teodor BOR
3. STANKOVIĆ, Đorđe KRU
- 5.
- 5.
- 7.
- 7.

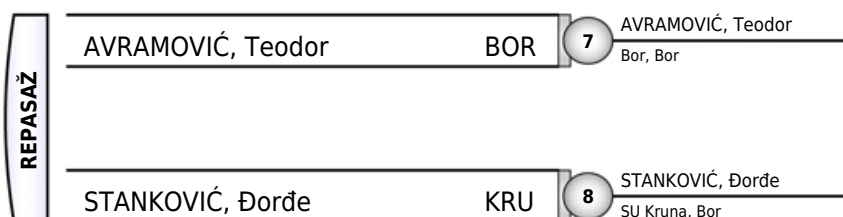



SOKOBANJA OPEN 2026

Sokobanja, 20.06.2026.

Stariji dečaci

-46KG

8 takmičara

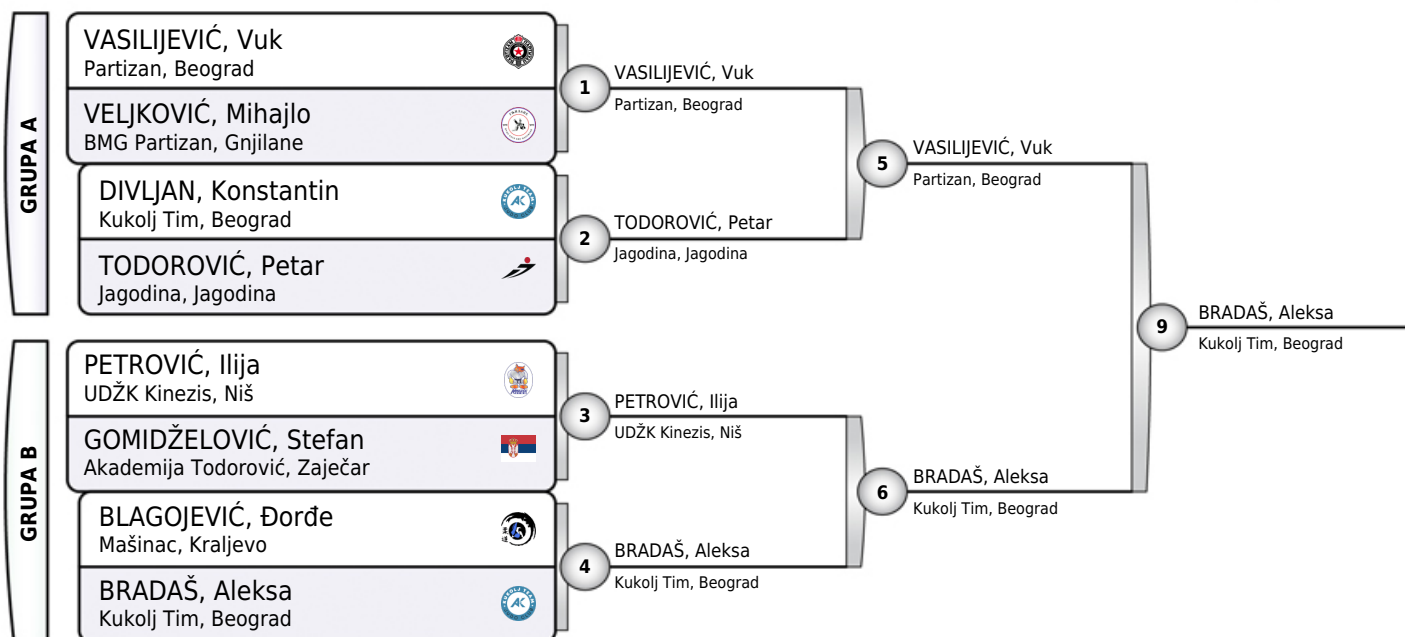

Rezultati

- BRADAŠ, Aleksa KTB
- VASILJEVIĆ, Vuk PBG
- VELJKOVIĆ, Mihajlo BMG
- PETROVIĆ, Ilija KIN
- TODOROVIĆ, Petar JAG
- BLAGOJEVIĆ, Đorđe MAŠ
-
-

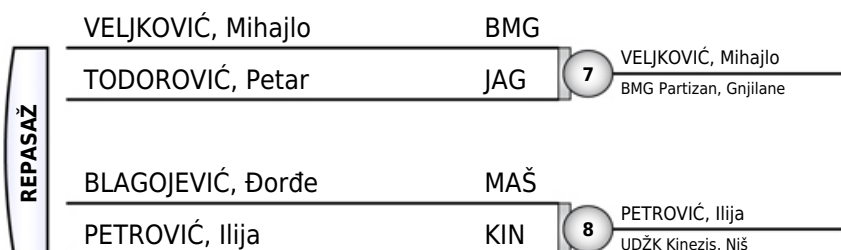



SOKOBANJA OPEN 2026

Sokobanja, 20.06.2026.

Stariji dečaci

-50KG

9 takmičara

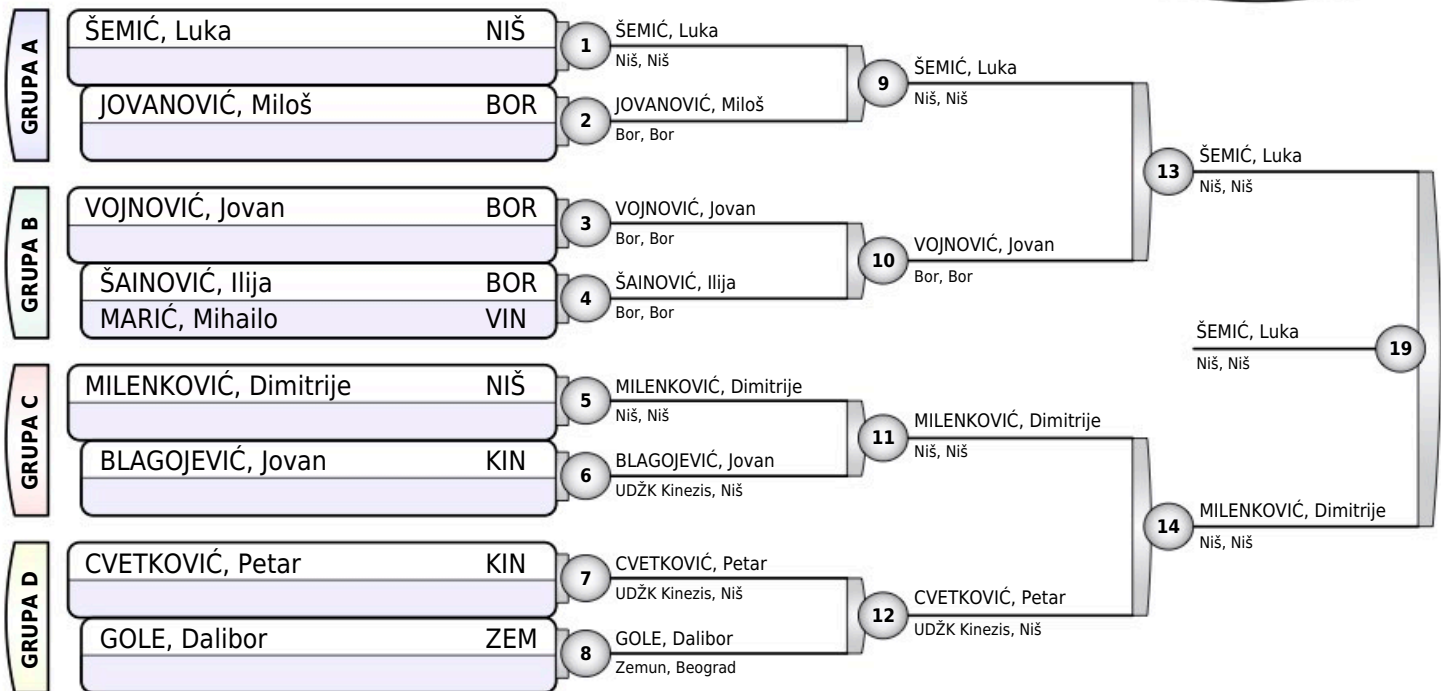

Rezultati

1. ŠEMIĆ, Luka NIŠ
2. MILENKOVIĆ, Dimitrije NIŠ
3. VOJNOVIĆ, Jovan BOR
3. CVETKOVIĆ, Petar KIN
5. JOVANOVIĆ, Miloš BOR
5. BLAGOJEVIĆ, Jovan KIN
- 7.
- 7.

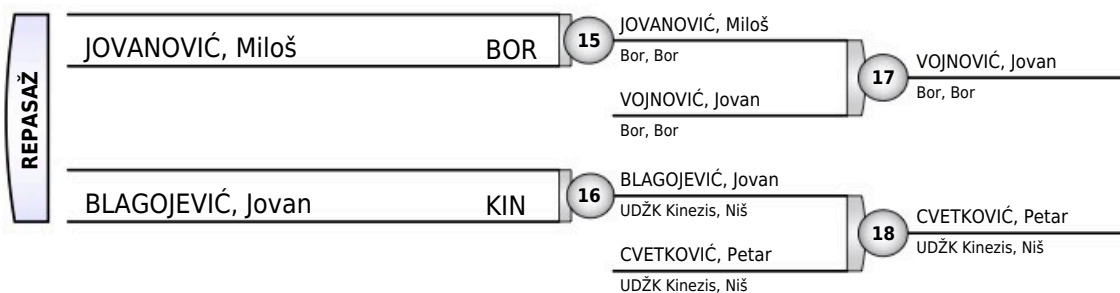



SOKOBANJA OPEN 2026

Sokobanja, 20.06.2026.

Stariji dečaci

-55KG

12 takmičara

GRUPA	Ime	Škola	Redni broj	Ime	Škola	Redni broj
GRUPA A	RISTIĆ, Uroš	KAR	1	RISTIĆ, Uroš	Džudo udruženje Karadorđević, Sokobanja	9
	OBRADOVIĆ, Nemanja	ZBG	2	MILIĆEVIĆ, Mihajlo	Džudo udruženje Karadorđević, Sokobanja	9
	MILIĆEVIĆ, Mihajlo	034		SU Radnički 034, Kragujevac		
GRUPA B	RADOMIROVIĆ, Dušan	MAŠ	3	RADOMIROVIĆ, Dušan	Mašincac, Kraljevo	10
	PETKOVIĆ, Vuk	BOR	4	PETKOVIĆ, Vuk	Bor, Bor	
	RANĐELOVIĆ, Andrej	JAG				
GRUPA C	MIJUŠKOVIĆ, Kosta	JAG	5	MIJUŠKOVIĆ, Kosta	Jagodina, Jagodina	11
	JOVANOVIĆ, Tadija	GVB	6	BELOPAVLOVIĆ, Vuk	Mašincac, Kraljevo	
	BELOPAVLOVIĆ, Vuk	MAŠ				
GRUPA D	RANISAVLJEVIĆ, Ilija	PLE	7	RANISAVLJEVIĆ, Ilija	Partizan Leskovac, Leskovac	12
	POTIĆ, Janko	I10	8	POTIĆ, Janko	SU "Ipon 10", Pirot	
	STANKOVIĆ, Lazar	VUK				

13 RISTIĆ, Uroš
Džudo udruženje Karadorđević, Sokobanja

19 RISTIĆ, Uroš
Džudo udruženje Karadorđević, Sokobanja

14 MIJUŠKOVIĆ, Kosta
Jagodina, Jagodina

Rezultati

1. RISTIĆ, Uroš KAR
2. MIJUŠKOVIĆ, Kosta JAG
3. PETKOVIĆ, Vuk BOR
3. RANISAVLJEVIĆ, Ilija PLE
5. MILIĆEVIĆ, Mihajlo 034
5. BELOPAVLOVIĆ, Vuk MAŠ
- 7.
- 7.

REPASAŽ	MILIĆEVIĆ, Mihajlo	034	15	MILIĆEVIĆ, Mihajlo	SU Radnički 034, Kragujevac	17
				PETKOVIĆ, Vuk	Bor, Bor	
	BELOPAVLOVIĆ, Vuk	MAŠ	16	BELOPAVLOVIĆ, Vuk	Mašincac, Kraljevo	18
				RANISAVLJEVIĆ, Ilija	Partizan Leskovac, Leskovac	



SOKOBANJA OPEN 2026

Sokobanja, 20.06.2026.

Stariji dečaci

-60KG

6 takmičara

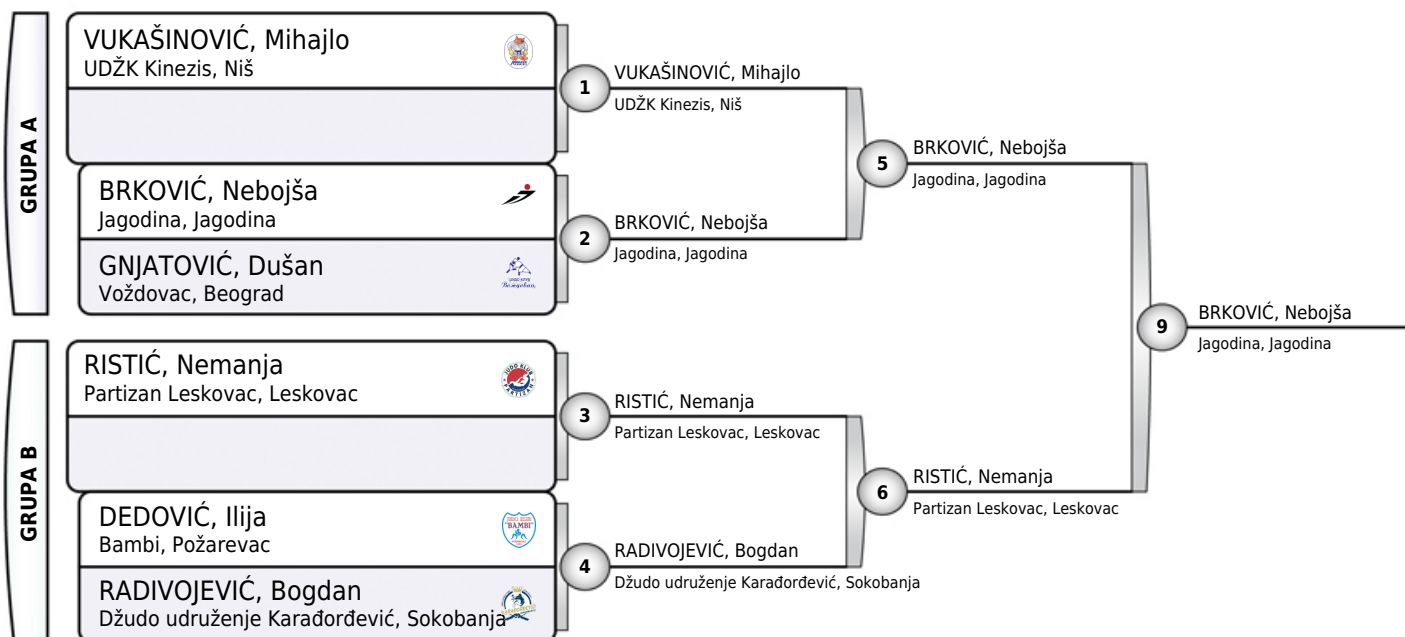

Rezultati

1. BRKOVIĆ, Nebojša JAG
2. RISTIĆ, Nemanja PLE
3. VUKAŠINOVIĆ, Mihajlo KIN
3. RADIVOJEVIĆ, Bogdan KAR
5. GNJATOVIĆ, Dušan VOŽ
- 7.
- 7.

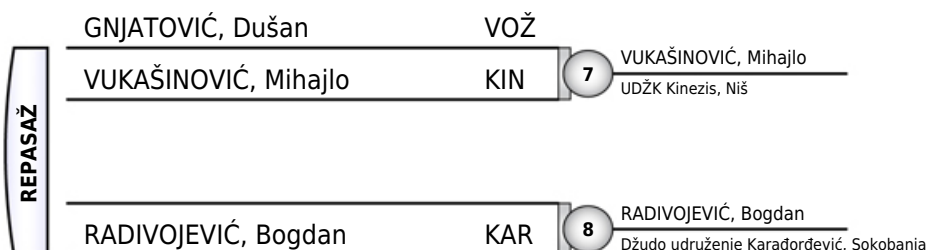



SOKOBANJA OPEN 2026

Sokobanja, 20.06.2026.

Stariji dečaci

-66KG

7 takmičara

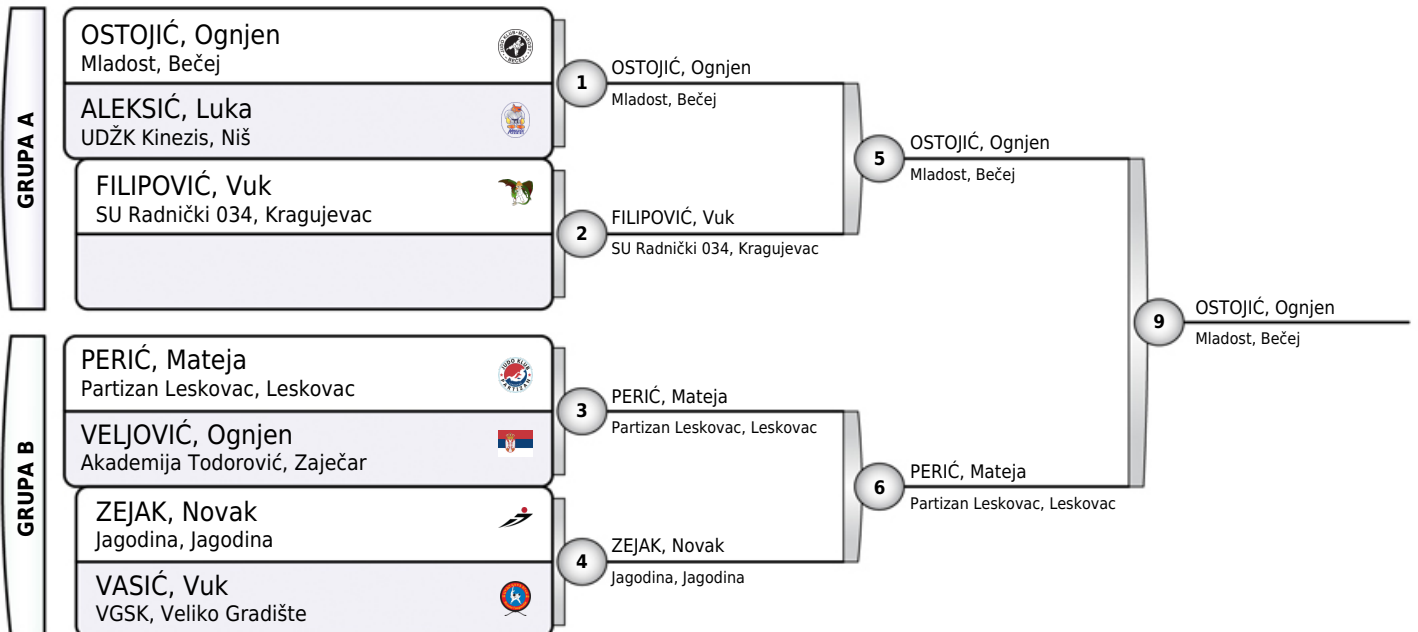

Rezultati

1. OSTOJIĆ, Ognjen MLA
2. PERIĆ, Mateja PLE
3. ALEKSIĆ, Luka KIN
3. ZEJAK, Novak JAG
5. FILIPOVIĆ, Vuk 034
5. VELJOVIĆ, Ognjen AKT
- 7.
- 7.

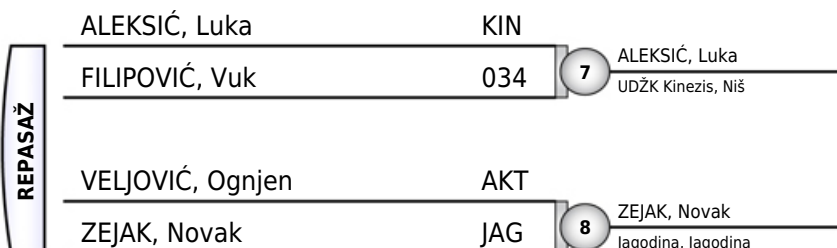



SOKOBANJA OPEN 2026

Sokobanja, 20.06.2026.

Stariji dečaci
-73KG
4 takmičara

Takmičar i klub	1	2	3	4	Pobeda	Bodova	Mesto
1 POPOVIĆ, Jovan Fajter, Obrenovac		0	0	0	0	0	3
2 VULETIĆ, Djordje Fajter, Obrenovac	100		0	100	2	200	2
3 ALEKSIĆ, Dimitrije Džudo udruženje Karađorđević, Sokobanja	100	100		100	3	300	1
4 VELJIĆ, Ognjen SU "Ipon 10", Pirot	1	0	0		1	1	3

POPOVIĆ, Jovan	FAJ	1	VULETIĆ, Djordje
VULETIĆ, Djordje	FAJ		Fajter, Obrenovac
ALEKSIĆ, Dimitrije	KAR	2	ALEKSIĆ, Dimitrije
VELJIĆ, Ognjen	I10		Džudo udruženje Karađorđević, Sokobanja
POPOVIĆ, Jovan	FAJ	3	ALEKSIĆ, Dimitrije
ALEKSIĆ, Dimitrije	KAR		Džudo udruženje Karađorđević, Sokobanja
VULETIĆ, Djordje	FAJ	4	VULETIĆ, Djordje
VELJIĆ, Ognjen	I10		Fajter, Obrenovac
POPOVIĆ, Jovan	FAJ	5	VELJIĆ, Ognjen
VELJIĆ, Ognjen	I10		SU "Ipon 10", Pirot
VULETIĆ, Djordje	FAJ	6	ALEKSIĆ, Dimitrije
ALEKSIĆ, Dimitrije	KAR		Džudo udruženje Karađorđević, Sokobanja

Rezultati

1. ALEKSIĆ, Dimitrije KAR
2. VULETIĆ, Djordje FAJ
3. VELJIĆ, Ognjen I10
3. POPOVIĆ, Jovan FAJ



SOKOBANJA OPEN 2026

Sokobanja, 20.06.2026.

Stariji dečaci

+73KG

3 takmičara

Takmičar i klub	1	2	3	Pobeda	Bodova	Mesto
1 CVETKOVIĆ, Ognjen Župa Aleksandrovac, Aleksandrovac		0	0	0	0	3
2 HAVAJIĆ, Dimitrije Zemun, Beograd	100		1	2	101	1
3 GLAVČIĆ, Bogdan Mašinac, Kraljevo	1	0		1	1	2

CVETKOVIĆ, Ognjen	ŽAL	1	HAVAJIĆ, Dimitrije
HAVAJIĆ, Dimitrije	ZEM		Zemun, Beograd
CVETKOVIĆ, Ognjen	ŽAL	2	GLAVČIĆ, Bogdan
GLAVČIĆ, Bogdan	MAŠ		Mašinac, Kraljevo
HAVAJIĆ, Dimitrije	ZEM	3	HAVAJIĆ, Dimitrije
GLAVČIĆ, Bogdan	MAŠ		Zemun, Beograd

Rezultati

1. HAVAJIĆ, Dimitrije ZEM
2. GLAVČIĆ, Bogdan MAŠ
3. CVETKOVIĆ, Ognjen ŽAL



SOKOBANJA OPEN 2026

Sokobanja, 20.06.2026.

Starije devojčice

-36KG

2 takmičarke

BOŽIĆ, Danina	PBG	1	BOŽIĆ, Danina Partizan, Beograd
STANOJEVIĆ, Julijana	KAR		
BOŽIĆ, Danina	PBG	2	BOŽIĆ, Danina Partizan, Beograd
STANOJEVIĆ, Julijana	KAR		
BOŽIĆ, Danina	PBG	3	
STANOJEVIĆ, Julijana	KAR		

Rezultati

1. BOŽIĆ, Danina PBG
2. STANOJEVIĆ, Julijana KAR



SOKOBANJA OPEN 2026

Sokobanja, 20.06.2026.

Starije devojčice

-40KG

1 takmičarka

CVETKOVIĆ, Danica

BMG

1

CVETKOVIĆ, Danica

BMG Partizan, Grijilane

Rezultati

1. CVETKOVIĆ, Danica

BMG



SOKOBANJA OPEN 2026

Sokobanja, 20.06.2026.

Starije devojčice

-44KG

2 takmičarke

ĆOĆIĆ, Nikolina	ŽAL	1	USAINOVIĆ, Helena
USAINOVIĆ, Helena	KAR		Džudo udruženje Karađorđević, Sokobanja
ĆOĆIĆ, Nikolina	ŽAL	2	USAINOVIĆ, Helena
USAINOVIĆ, Helena	KAR		Džudo udruženje Karađorđević, Sokobanja
ĆOĆIĆ, Nikolina	ŽAL	3	
USAINOVIĆ, Helena	KAR		

Rezultati

1. USAINOVIĆ, Helena KAR
2. ĆOĆIĆ, Nikolina ŽAL



SOKOBANJA OPEN 2026

Sokobanja, 20.06.2026.

Starije devojčice

-48KG

3 takmičarke

Takmičar i klub	1	2	3	Pobeda	Bodova	Mesto
1 ĐORĐEVIĆ, Tamara BMG Partizan, Gnjilane		100	0	1	100	2
2 ILIĆ, Emilija VGSK, Veliko Gradište	0		0	0	0	3
3 STOILJKOVIĆ, Nikolina Partizan Leskovac, Leskovac	100	100		2	200	1

ĐORĐEVIĆ, Tamara	BMG	1	ĐORĐEVIĆ, Tamara
ILIĆ, Emilija	VGS		BMG Partizan, Gnjilane
ĐORĐEVIĆ, Tamara	BMG	2	STOILJKOVIĆ, Nikolina
STOILJKOVIĆ, Nikolina	PLE		Partizan Leskovac, Leskovac
ILIĆ, Emilija	VGS	3	STOILJKOVIĆ, Nikolina
STOILJKOVIĆ, Nikolina	PLE		Partizan Leskovac, Leskovac

Rezultati

1. STOILJKOVIĆ, Nikolina PLE
2. ĐORĐEVIĆ, Tamara BMG
3. ILIĆ, Emilija VGS



SOKOBANJA OPEN 2026

Sokobanja, 20.06.2026.

Starije devojčice

-52KG

2 takmičarke

SIMIĆ, Irina	PLE	1	SIMIĆ, Irina Partizan Leskovac, Leskovac
ĐORĐEVIĆ, Teodora	BMG		
SIMIĆ, Irina	PLE	2	SIMIĆ, Irina Partizan Leskovac, Leskovac
ĐORĐEVIĆ, Teodora	BMG		
SIMIĆ, Irina	PLE	3	
ĐORĐEVIĆ, Teodora	BMG		

Rezultati

1. SIMIĆ, Irina PLE
2. ĐORĐEVIĆ, Teodora BMG



SOKOBANJA OPEN 2026

Sokobanja, 20.06.2026.

Starije devojčice

-57KG

6 takmičarki

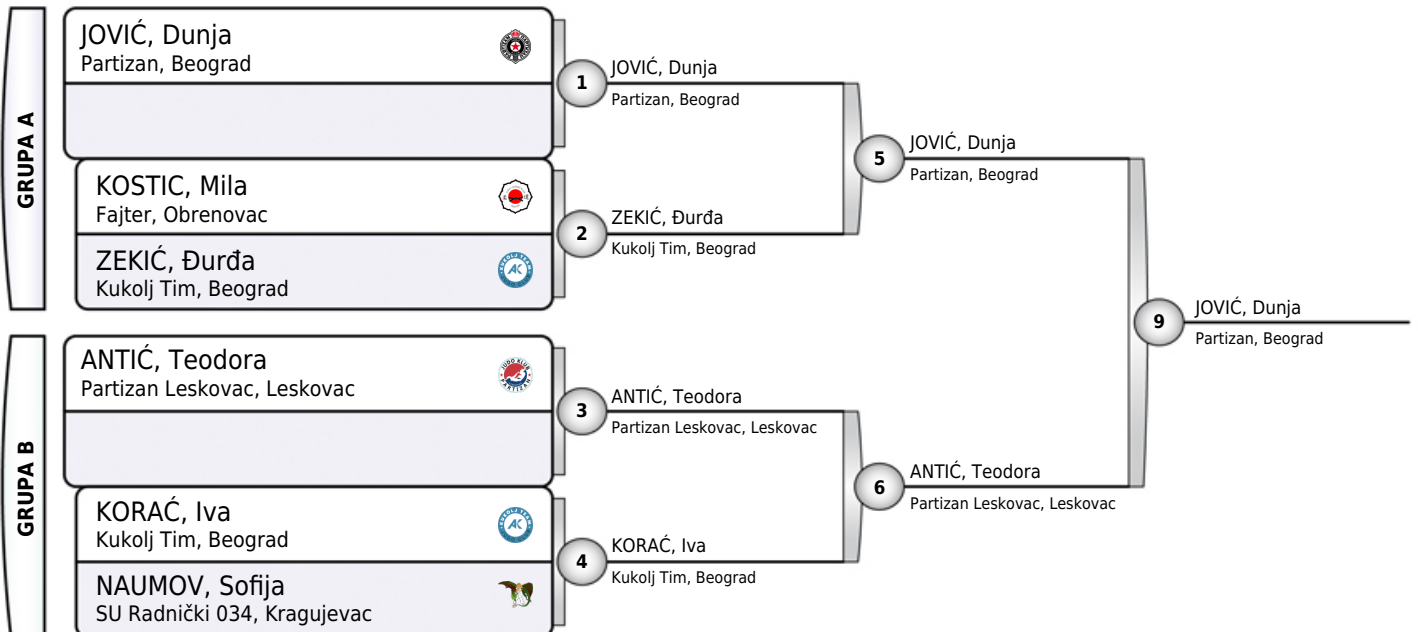

Rezultati

1. JOVIĆ, Dunja PBG
2. ANTIĆ, Teodora PLE
3. ZEKIĆ, Đurđa KTB
3. KORAĆ, Iva KTB
- 5.
- 5.
- 7.
- 7.

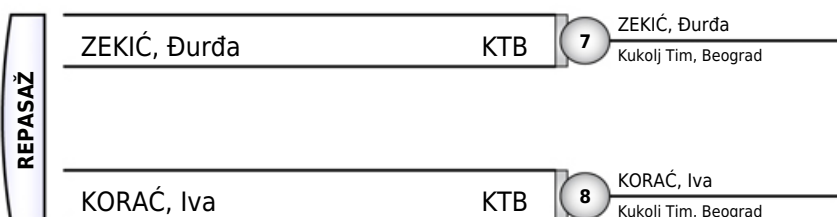



SOKOBANJA OPEN 2026

Sokobanja, 20.06.2026.

Starije devojčice

-63KG

3 takmičarke

Takmičar i klub	1	2	3	Pobeda	Bodova	Mesto
1 PANTIĆ, Anđela Vinča, Beograd		0	0	0	0	3
2 PANTELIĆ, Lena Fajter, Obrenovac	100		0	1	100	2
3 GAŠIĆ, Lena Vinča, Beograd	100	10		2	110	1

PANTIĆ, Anđela	VIN	1	PANTELIĆ, Lena
PANTELIĆ, Lena	FAJ		Fajter, Obrenovac
PANTIĆ, Anđela	VIN	2	GAŠIĆ, Lena
GAŠIĆ, Lena	VIN		Vinča, Beograd
PANTELIĆ, Lena	FAJ	3	GAŠIĆ, Lena
GAŠIĆ, Lena	VIN		Vinča, Beograd

Rezultati

1. GAŠIĆ, Lena VIN
2. PANTELIĆ, Lena FAJ
3. PANTIĆ, Anđela VIN



SOKOBANJA OPEN 2026

Sokobanja, 20.06.2026.

Starije devojčice

+63KG

7 takmičarki

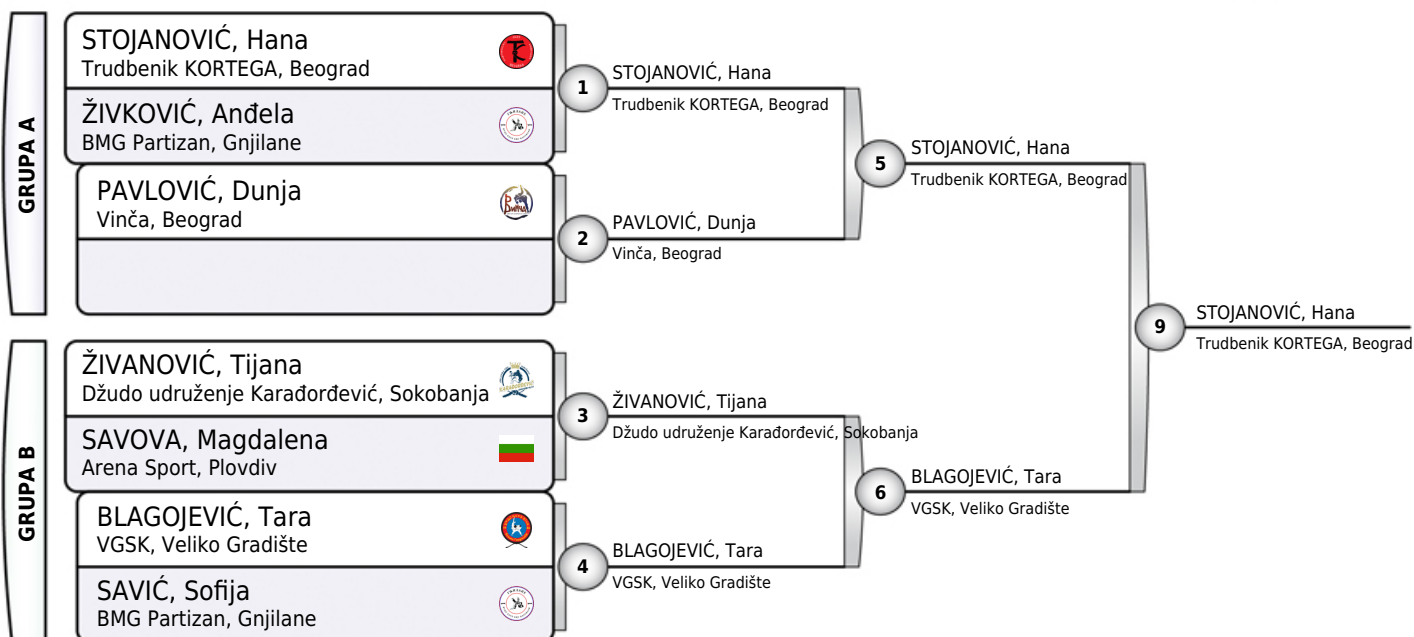

Rezultati

1. STOJANOVIĆ, Hana TKS
2. BLAGOJEVIĆ, Tara VGS
3. ŽIVKOVIĆ, Anđela BMG
3. ŽIVANOVIĆ, Tijana KAR
5. PAVLOVIĆ, Dunja VIN
5. SAVIĆ, Sofija BMG
- 7.
- 7.

