



SREBRNO JEZERO 2026 I DAN

Veliko Gradište, 13.06.2026.

Stariji poletarci

-25KG

6 takmičara

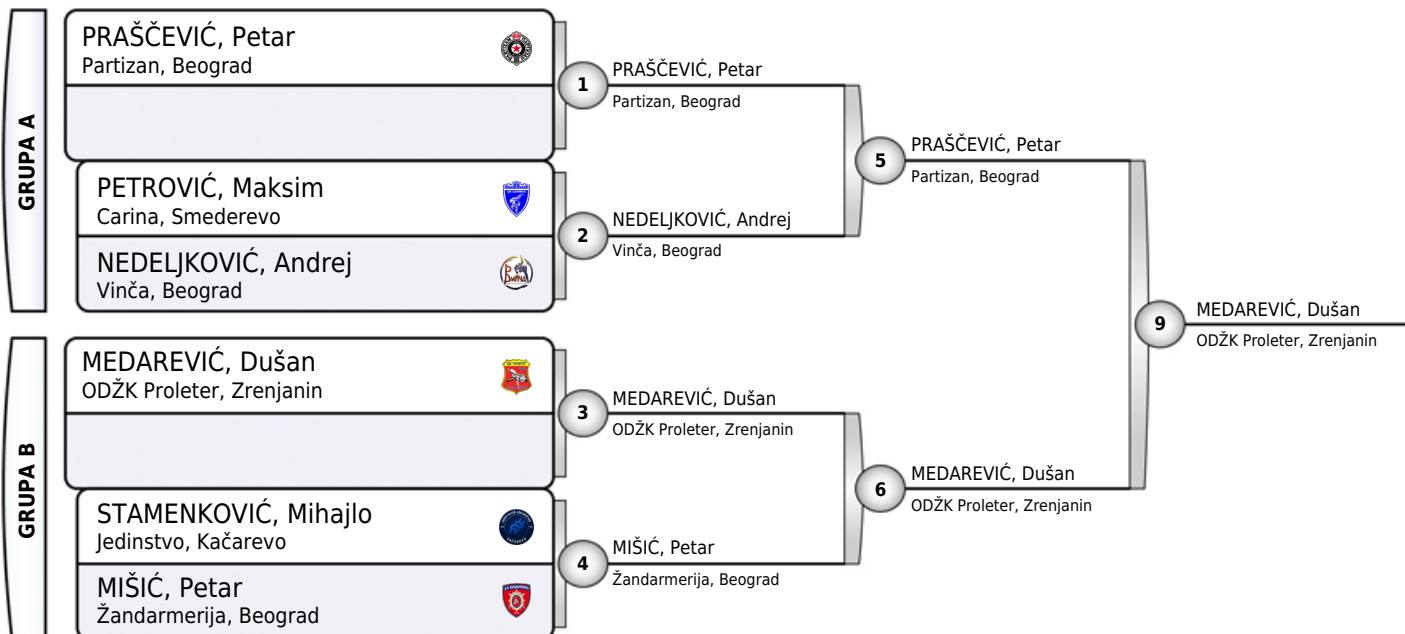

Rezultati

1. MEDAREVIĆ, Dušan PRO
2. PRAŠČEVIĆ, Petar PBG
3. NEDELJKOVIĆ, Andrej VIN
3. MIŠIĆ, Petar ŽAN
- 5.
- 5.
- 7.
- 7.

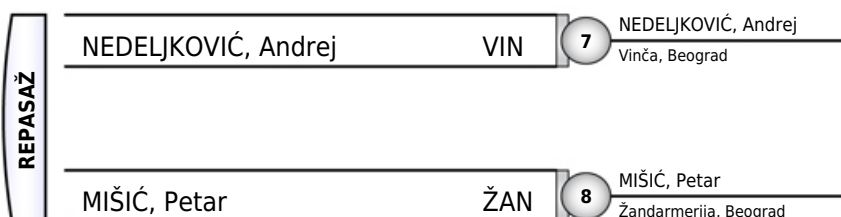



SREBRNO JEZERO 2026 I DAN

Veliko Gradište, 13.06.2026.

Stariji poletarci

-28KG

21 takmičara

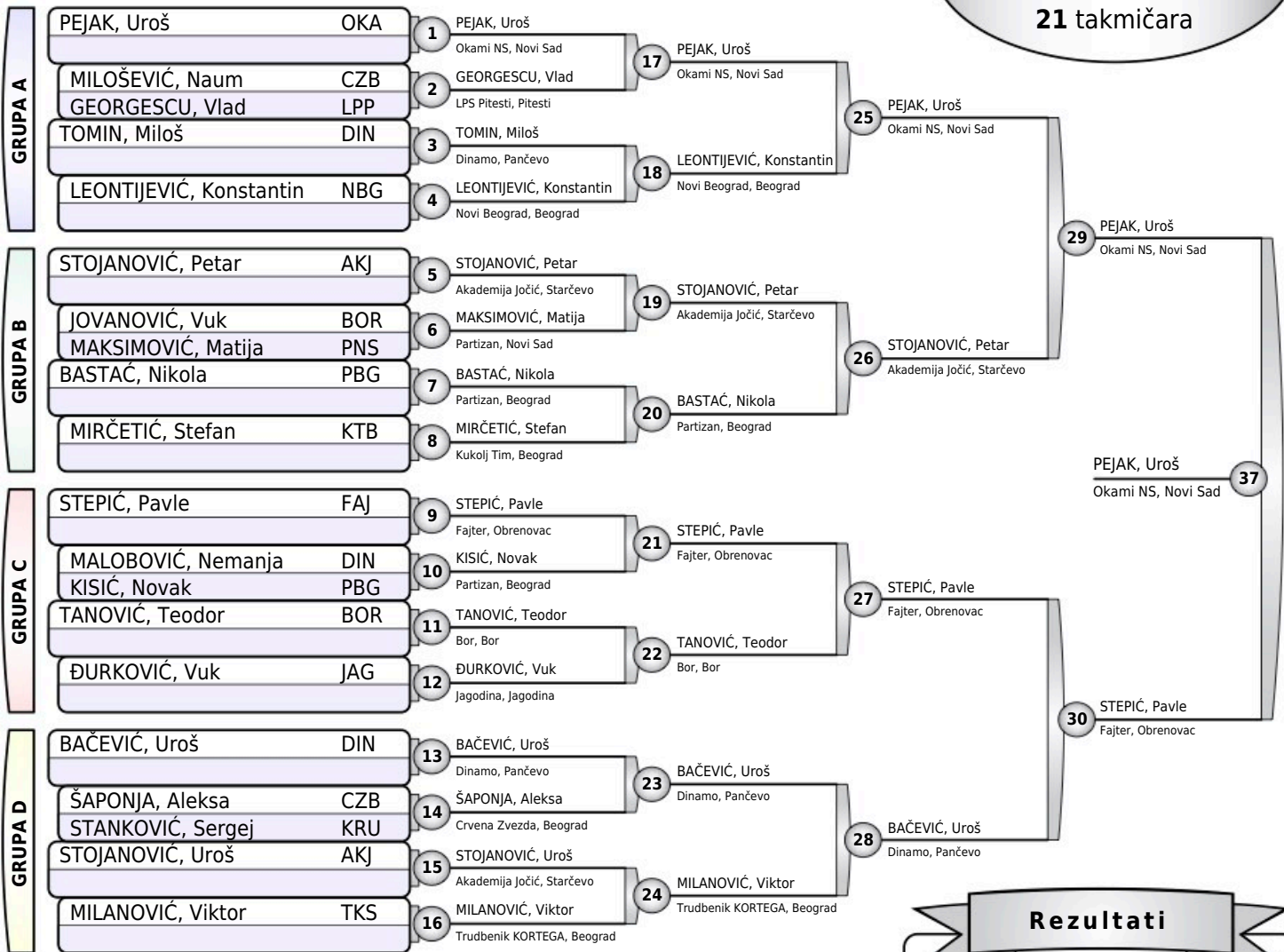

Rezultati

1. PEJAK, Uroš OKA
2. STEPIĆ, Pavle FAJ
3. STOJANOVIĆ, Petar AKJ
3. BAČEVIĆ, Uroš DIN
5. LEONTIJEVIĆ, Konstantin NBG
5. TANOVIĆ, Teodor BOR
7. GEORGESCU, Vlad LPP
7. KISIĆ, Novak PBG



SREBRNO JEZERO 2026 I DAN

Veliko Gradište, 13.06.2026.

Stariji poletarci

-34KG

25 takmičara

| GRUPA | Redni broj | Ime i Prezime | Klub | Redni broj | Ime i Prezime | Klub |
|---------|------------|--------------------|------|------------|--------------------|---|
| GRUPA A | 1 | ANDREJEVIĆ, Bogdan | KAR | 17 | ANDREJEVIĆ, Bogdan | Džudo udruženje Karadordević, Sokobanja |
| | 2 | MATOVIĆ, Rastko | ZBG | 18 | BOŽIĆ, Nikola | Bor, Bor |
| | | KOLUNDŽIĆ, Vukan | CZB | 19 | RABRENOVIĆ, David | ODŽK Beograd, Beograd |
| | 3 | BOŽIĆ, Nikola | BOR | 20 | ĆORIĆ, Stefan | Hajime, Obrenovac |
| | 4 | MILOŠEV, Siniša | PBG | 21 | ĐORĐEVIĆ, Tika | Džudo udruženje Karadordević, Sokobanja |
| | | PETROVIĆ, Andrej | ZBG | 22 | JEREMIĆ, Andrija | Kukulj Tim, Beograd |
| GRUPA B | 5 | RABRENOVIĆ, David | OJK | 23 | ŠUPIĆ, Tadija | ODŽK Beograd, Beograd |
| | 6 | PAJKIĆ, Petar | VGS | 24 | KOVAČEVIĆ, Gavrilo | Crvena Zvezda, Beograd |
| | 7 | GALIĆ, Gavriilo | ŽBG | 25 | PETROVIĆ, Nikola | Crvena Zvezda, Beograd |
| | 8 | ĆORIĆ, Stefan | HAJ | 26 | MILORADOVIĆ, Luka | VIN |
| | 9 | PJEVAČ, Vladimir | CZB | 27 | JEREMIĆ, Andrija | Kukulj Tim, Beograd |
| | 10 | PETROV, Stefan | AKJ | 28 | ŠUPIĆ, Tadija | ODŽK Beograd, Beograd |
| GRUPA C | 11 | VUKOVIĆ, Damjan | OKA | 29 | ANDREJEVIĆ, Bogdan | Džudo udruženje Karadordević, Sokobanja |
| | 12 | ĐORĐEVIĆ, Tika | KAR | 30 | JEREMIĆ, Andrija | Kukulj Tim, Beograd |
| | 13 | MARKOVIĆ, Filip | BOR | 31 | KOLUNDŽIĆ, Vukan | Crvena Zvezda, Beograd |
| | 14 | STOJANOVIĆ, Luka | OJK | 32 | LUKIĆ, Toma | SU Radnički 034, Kragujevac |
| | 15 | JEREMIĆ, Andrija | KTB | 33 | BOŽIĆ, Nikola | Bor, Bor |
| | 16 | LUKIĆ, Toma | 034 | 34 | ĐORĐEVIĆ, Tika | Džudo udruženje Karadordević, Sokobanja |
| GRUPA D | 17 | NEDOVIĆ, Vaso | ZBG | 35 | RABRENOVIĆ, David | ODŽK Beograd, Beograd |
| | 18 | ŠUPIĆ, Tadija | OJK | 36 | ĐORĐEVIĆ, Tika | Džudo udruženje Karadordević, Sokobanja |
| | 19 | ĐAKOVIĆ, Ognjen | ŽAL | | | |
| | 20 | POPOVIĆ, Andrija | MAK | | | |
| | 21 | KOVAČEVIĆ, Gavrilo | CZB | | | |
| | 22 | PETROVIĆ, Nikola | ŽAN | | | |

Rezultati

- ANDREJEVIĆ, Bogdan KAR
- JEREMIĆ, Andrija KTB
- RABRENOVIĆ, David OJK
- ĐORĐEVIĆ, Tika KAR
- BOŽIĆ, Nikola BOR
- ŠUPIĆ, Tadija OJK
- KOLUNDŽIĆ, Vukan CZB
- LUKIĆ, Toma 034

| REPASAŽ | Redni broj | Ime i Prezime | Klub | Redni broj | Ime i Prezime | Klub |
|---------|------------|-------------------|---|------------|-------------------|---|
| | 31 | KOLUNDŽIĆ, Vukan | CZB | 33 | BOŽIĆ, Nikola | Bor, Bor |
| | 32 | LUKIĆ, Toma | 034 | 34 | ĐORĐEVIĆ, Tika | Džudo udruženje Karadordević, Sokobanja |
| | 33 | BOŽIĆ, Nikola | Bor, Bor | 35 | RABRENOVIĆ, David | ODŽK Beograd, Beograd |
| | 34 | ĐORĐEVIĆ, Tika | Džudo udruženje Karadordević, Sokobanja | 36 | ĐORĐEVIĆ, Tika | Džudo udruženje Karadordević, Sokobanja |
| | 35 | RABRENOVIĆ, David | ODŽK Beograd, Beograd | | | |
| | 36 | ŠUPIĆ, Tadija | ODŽK Beograd, Beograd | | | |



SREBRNO JEZERO 2026 I DAN

Veliko Gradište, 13.06.2026.

Stariji poletarci

-38KG

19 takmičara

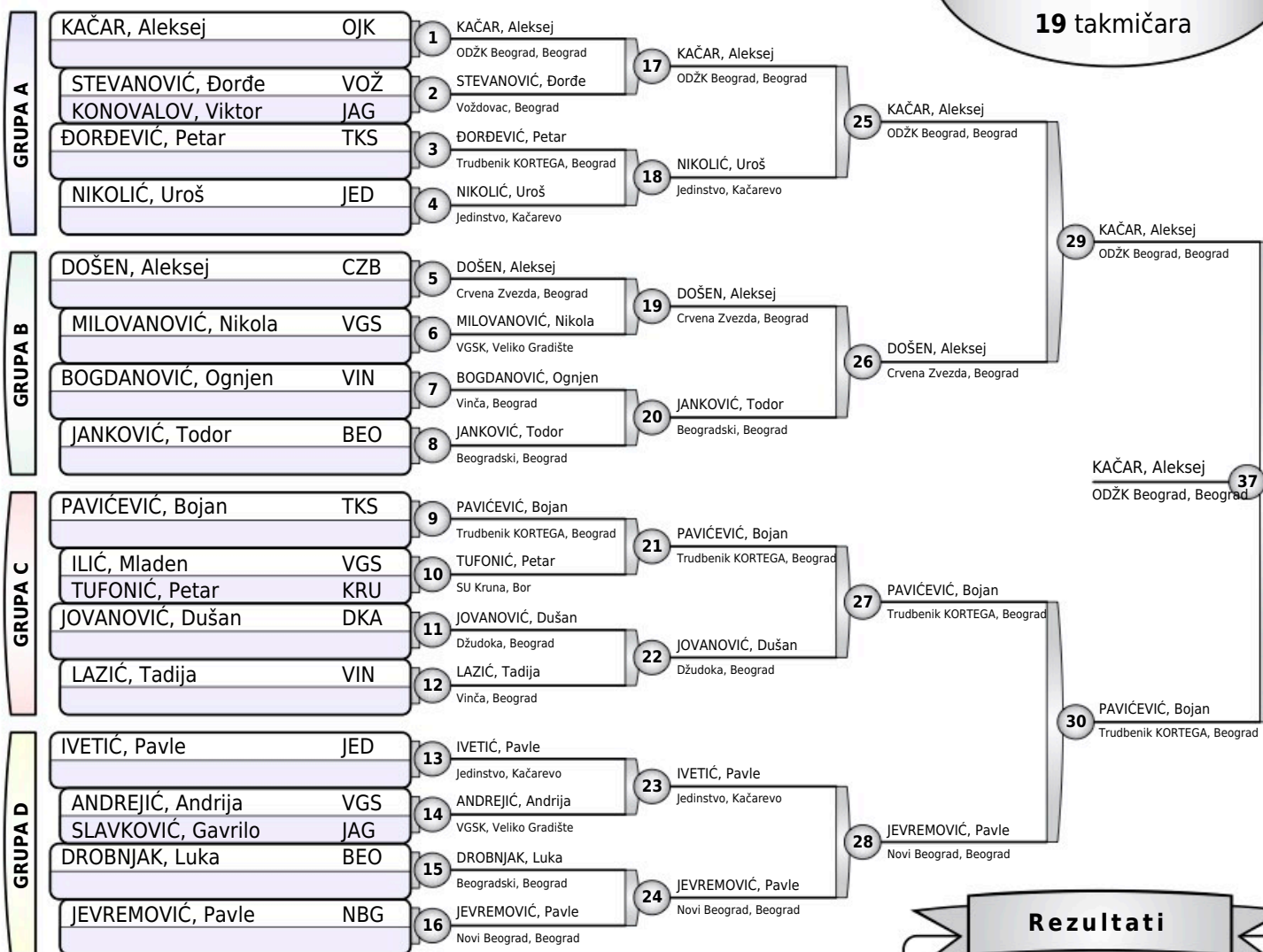

Rezultati

- KAČAR, Aleksej OJK
- PAVIĆEVIĆ, Bojan TKS
- NIKOLIĆ, Uroš JED
- TUFONIĆ, Petar KRU
- DOŠEN, Aleksej CZB
- JEVREMOVIĆ, Pavle NBG
- STEVANOVIĆ, Đorđe VOŽ
- JOVANOVIĆ, Dušan DKA

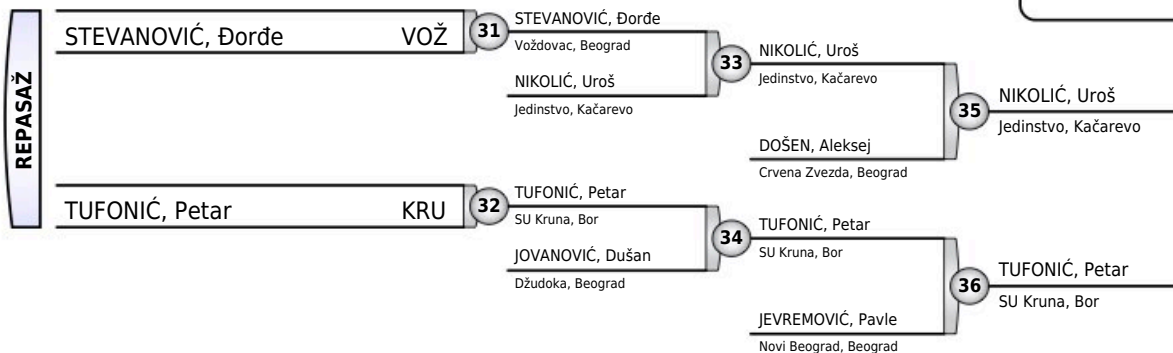



SREBRNO JEZERO 2026 I DAN

Veliko Gradište, 13.06.2026.

Stariji poletarci

-42KG

12 takmičara

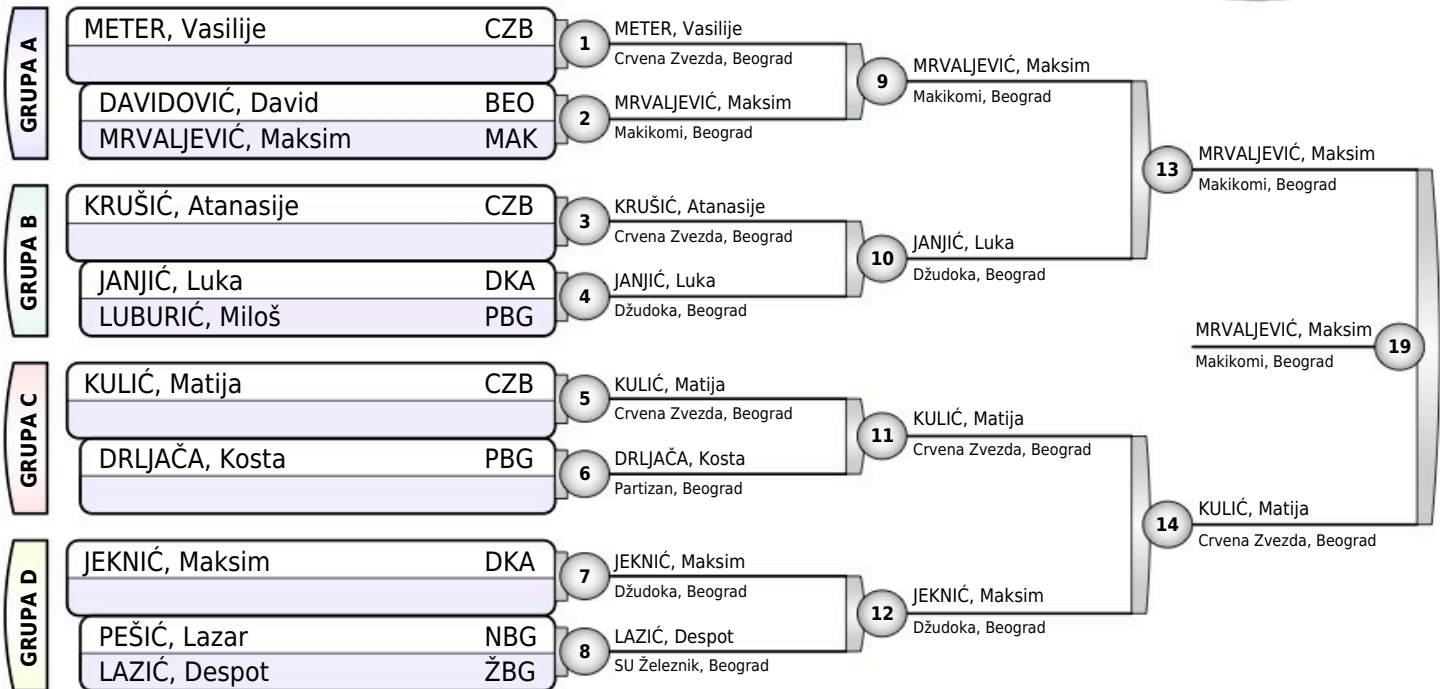

Rezultati

1. MRVALJEVIĆ, Maksim MAK
2. KULIĆ, Matija CZB
3. METER, Vasilije CZB
3. DRLJAČA, Kosta PBG
5. JANJIĆ, Luka DKA
5. JEKNIĆ, Maksim DKA
7. DAVIDOVIĆ, David BEO
- 7.

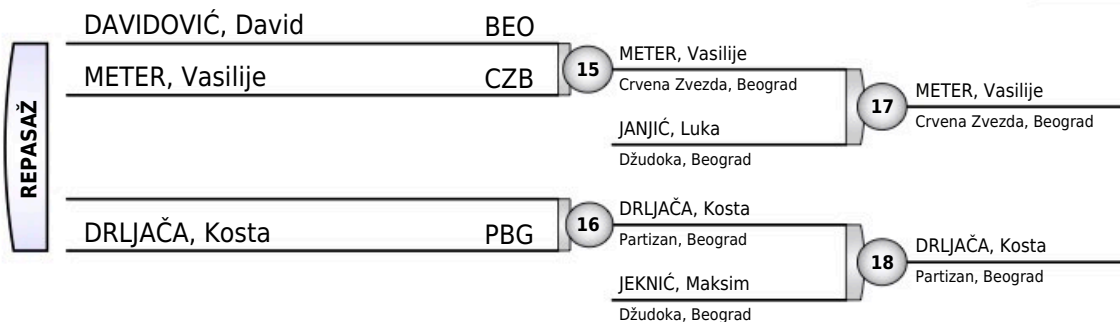



SREBRNO JEZERO 2026 I DAN

Veliko Gradište, 13.06.2026.

Stariji poletarci

-46KG

13 takmičara

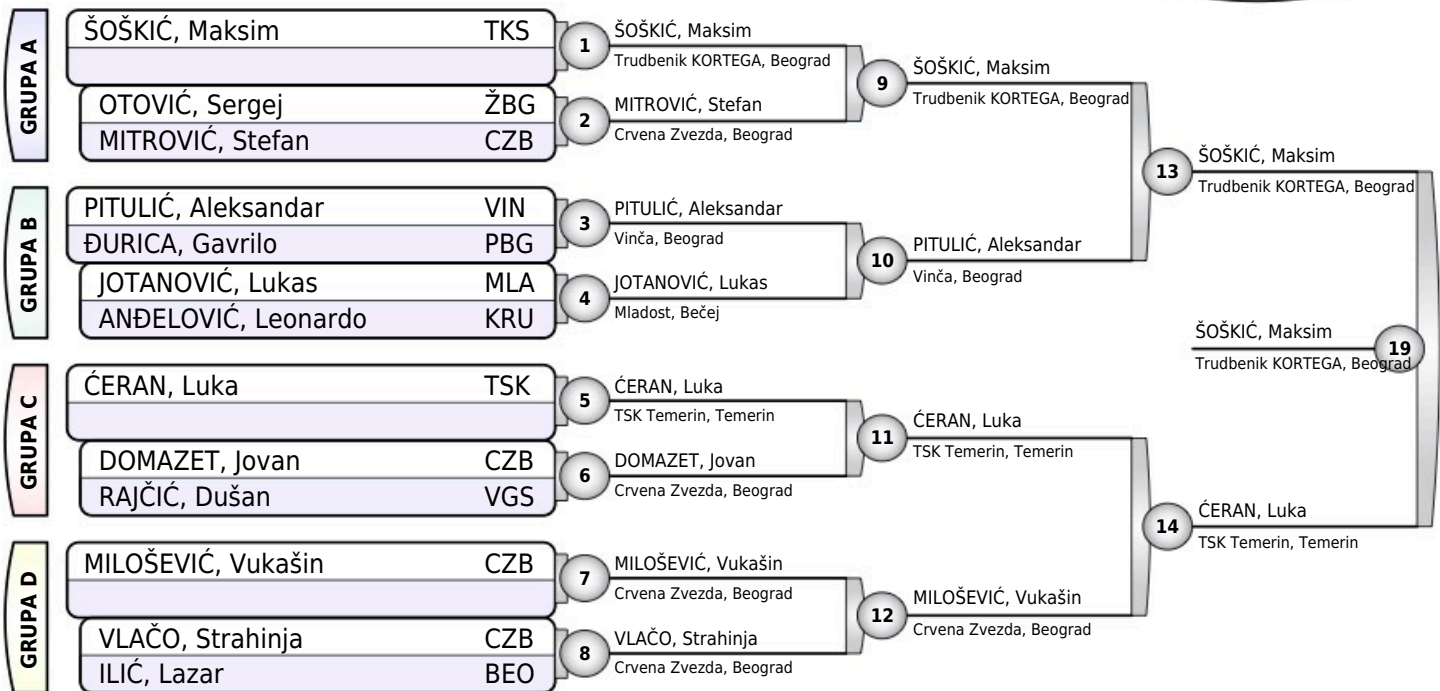

Rezultati

1. ŠOŠKIĆ, Maksim (TKS)
2. ĆERAN, Luka (TSK)
3. PITULIĆ, Aleksandar (VIN)
3. DOMAZET, Jovan (CZB)
5. MITROVIĆ, Stefan (CZB)
5. MILOŠEVIĆ, Vukašin (CZB)
- 7.
- 7.

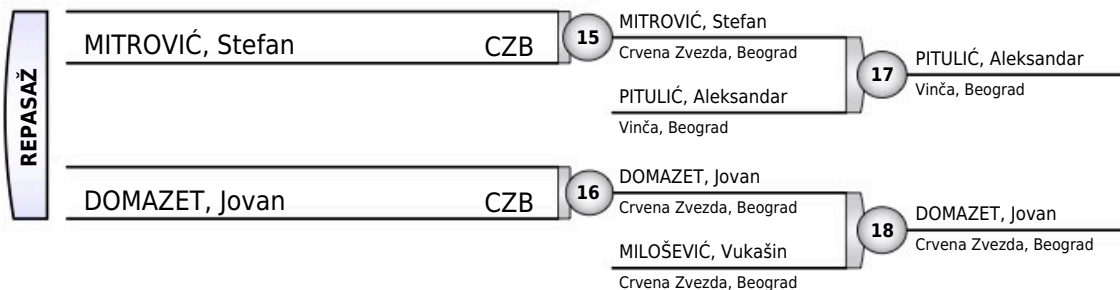



SREBRNO JEZERO 2026 I DAN

Veliko Gradište, 13.06.2026.

Stariji poletarci

-50KG

5 takmičara

| Takmičar i klub | 1 | 2 | 3 | 4 | 5 | Pobeda | Bodova | Mesto |
|--|-----|-----|-----|-----|---|--------|--------|-------|
| 1 NIČIĆ, Matija SU Goč VB, Vrnjačka Banja | | 0 | 0 | 1 | 0 | 1 | 1 | 3 |
| 2 KOSTIĆ, Stefan Bambi, Požarevac | 1 | | 0 | 10 | 0 | 2 | 11 | 3 |
| 3 VRAČEVIĆ, Aleksej Kukolj Tim, Beograd | 100 | 100 | | 100 | 0 | 3 | 300 | 2 |
| 4 RADANOVIĆ, Petar Mladost, Bečej | 0 | 0 | 0 | | 0 | 0 | 0 | 5 |
| 5 DIMITRIJEVIĆ, Bogdan Jagodina, Jagodina | 100 | 100 | 100 | 100 | | 4 | 400 | 1 |

| | | | |
|----------------------|-----|----|---------------------------|
| NIČIĆ, Matija | GVB | 1 | KOSTIĆ, Stefan |
| KOSTIĆ, Stefan | BAM | | Bambi, Požarevac |
| VRAČEVIĆ, Aleksej | KTB | 2 | VRAČEVIĆ, Aleksej |
| RADANOVIĆ, Petar | MLA | | Kukolj Tim, Beograd |
| NIČIĆ, Matija | GVB | 3 | DIMITRIJEVIĆ, Bogdan |
| DIMITRIJEVIĆ, Bogdan | JAG | | Jagodina, Jagodina |
| KOSTIĆ, Stefan | BAM | 4 | VRAČEVIĆ, Aleksej |
| VRAČEVIĆ, Aleksej | KTB | | Kukolj Tim, Beograd |
| RADANOVIĆ, Petar | MLA | 5 | DIMITRIJEVIĆ, Bogdan |
| DIMITRIJEVIĆ, Bogdan | JAG | | Jagodina, Jagodina |
| NIČIĆ, Matija | GVB | 6 | VRAČEVIĆ, Aleksej |
| VRAČEVIĆ, Aleksej | KTB | | Kukolj Tim, Beograd |
| KOSTIĆ, Stefan | BAM | 7 | KOSTIĆ, Stefan |
| RADANOVIĆ, Petar | MLA | | Bambi, Požarevac |
| VRAČEVIĆ, Aleksej | KTB | 8 | DIMITRIJEVIĆ, Bogdan |
| DIMITRIJEVIĆ, Bogdan | JAG | | Jagodina, Jagodina |
| NIČIĆ, Matija | GVB | 9 | NIČIĆ, Matija |
| RADANOVIĆ, Petar | MLA | | SU Goč VB, Vrnjačka Banja |
| KOSTIĆ, Stefan | BAM | 10 | DIMITRIJEVIĆ, Bogdan |
| DIMITRIJEVIĆ, Bogdan | JAG | | Jagodina, Jagodina |

Rezultati

1. DIMITRIJEVIĆ, Bogdan JAG
2. VRAČEVIĆ, Aleksej KTB
3. KOSTIĆ, Stefan BAM
3. NIČIĆ, Matija GVB
5. RADANOVIĆ, Petar MLA



SREBRNO JEZERO 2026 I DAN

Veliko Gradište, 13.06.2026.

Stariji poletarci

+50KG

8 takmičara

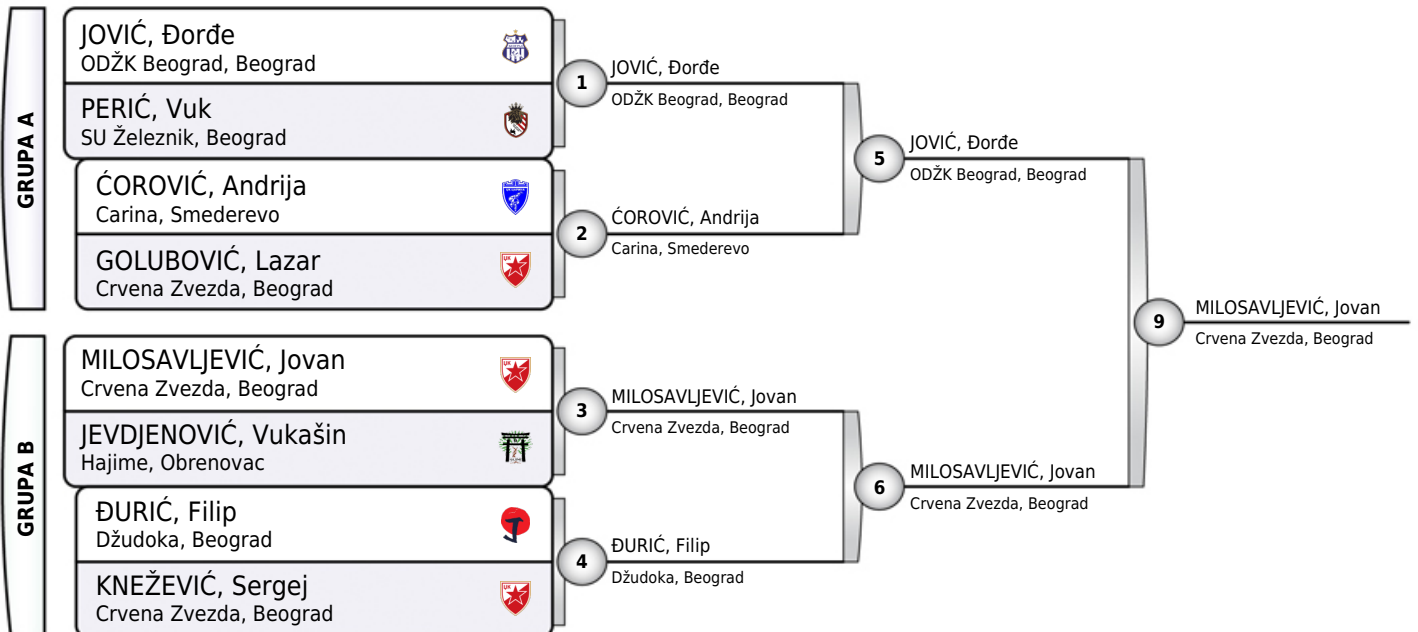

Rezultati

1. MILOSAVLJEVIĆ, Jovan CZB
2. JOVIĆ, Đorđe OJK
3. ĆOROVIĆ, Andrija CAR
3. JEVDJENOVIĆ, Vukašin HAJ
5. PERIĆ, Vuk ŽBG
5. ĐURIĆ, Filip DKA
- 7.
- 7.

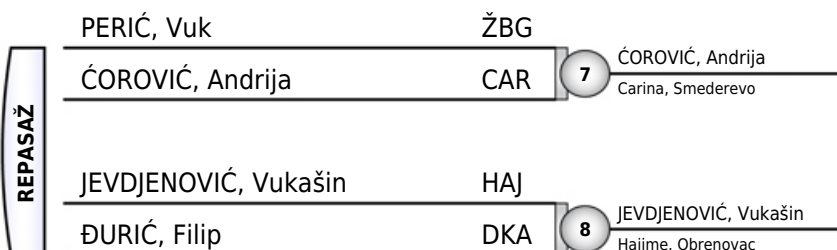



SREBRNO JEZERO 2026 I DAN

Veliko Gradište, 13.06.2026.

Starije poletarke

-22KG

1 takmičarka

JANKOVIĆ, Nina

ŽBG

1

JANKOVIĆ, Nina

SU Železnik, Beograd

Rezultati

1. JANKOVIĆ, Nina

ŽBG



SREBRNO JEZERO 2026 I DAN

Veliko Gradište, 13.06.2026.

Starije poletarke

-25KG

6 takmičarki

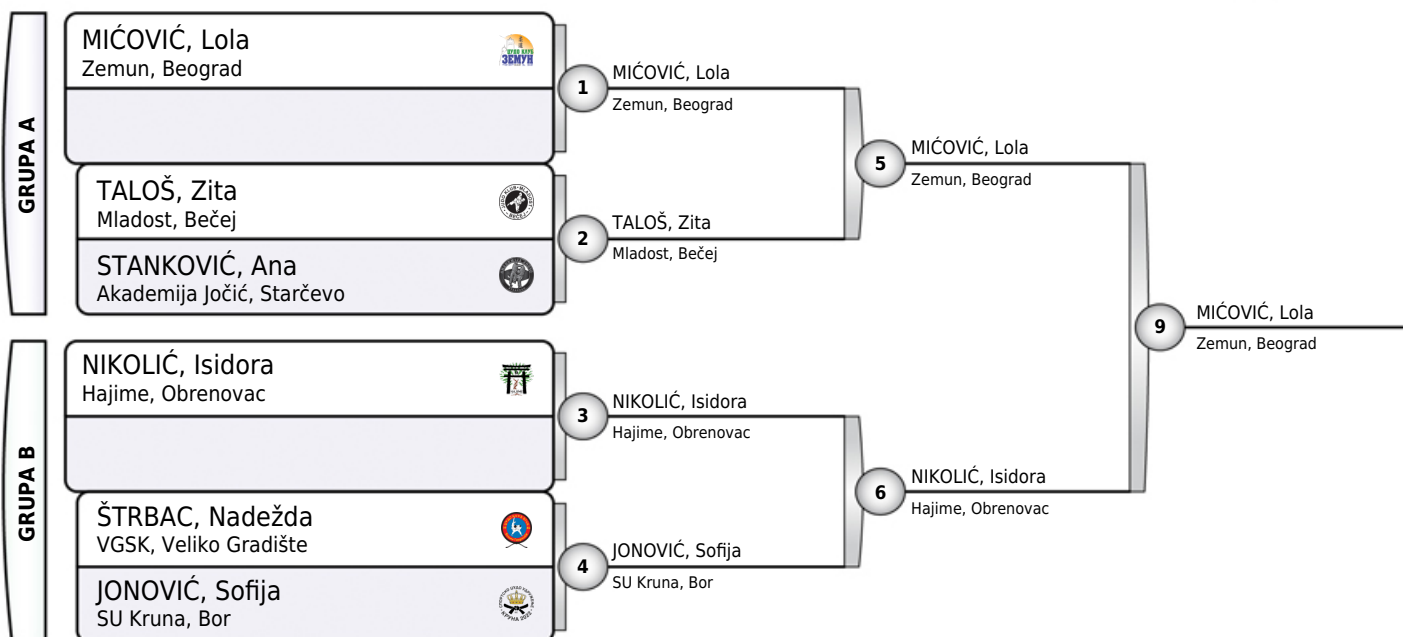

Rezultati

1. MIĆOVIĆ, Lola ZEM
2. NIKOLIĆ, Isidora HAJ
3. TALOŠ, Zita MLA
3. JONOVIĆ, Sofija KRU
- 5.
- 5.
- 7.
- 7.

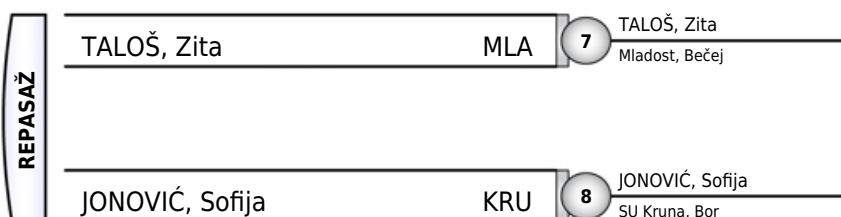



SREBRNO JEZERO 2026 I DAN

Veliko Gradište, 13.06.2026.

Starije poletarke

-28KG

10 takmičarki

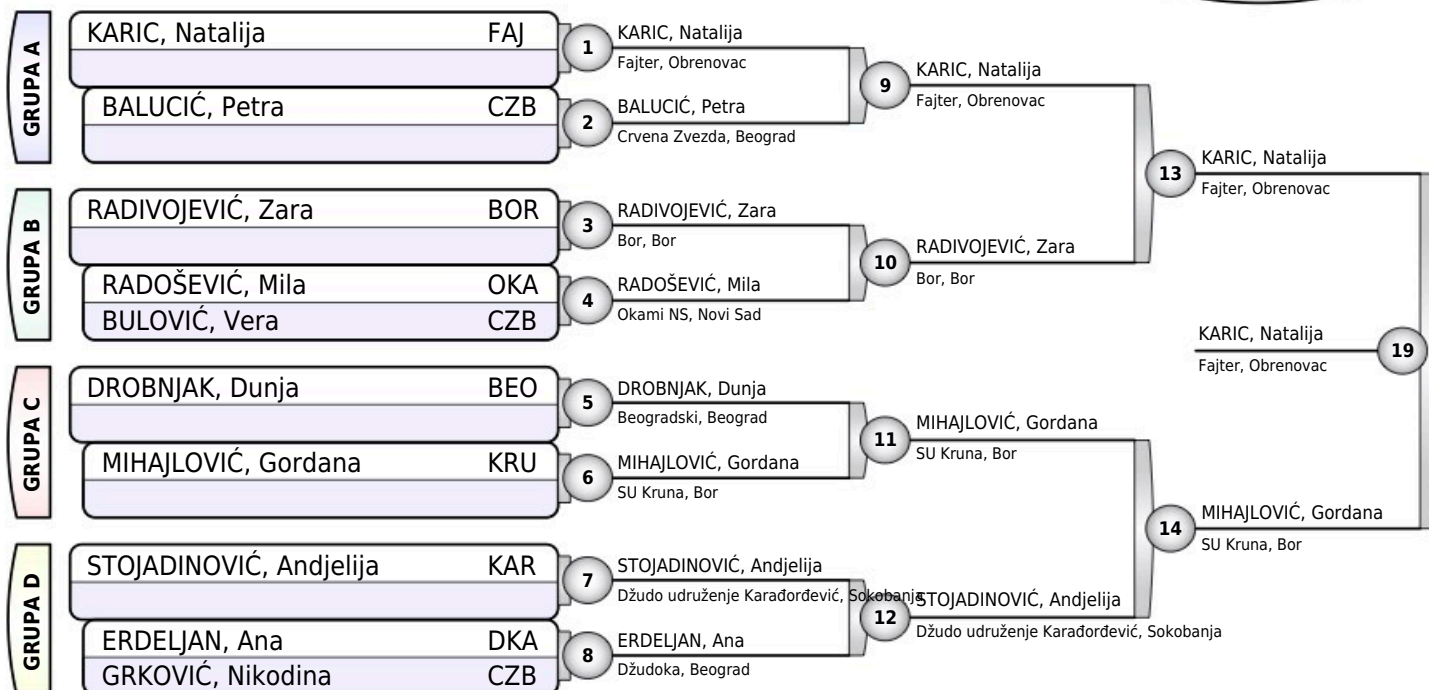

Rezultati

1. KARIC, Natalija FAJ
2. MIHAJLOVIĆ, Gordana KRU
3. RADIVOJEVIĆ, Zara BOR
3. DROBNJAK, Dunja BEO
5. BALUCIĆ, Petra CZB
5. STOJADINOVIĆ, Andjelija KAR
- 7.
- 7.

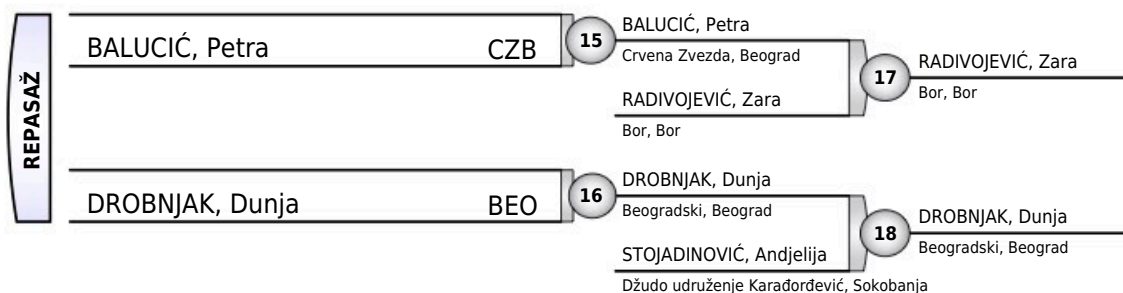



SREBRNO JEZERO 2026 I DAN

Veliko Gradište, 13.06.2026.

Starije poletarke

-31KG

12 takmičarki

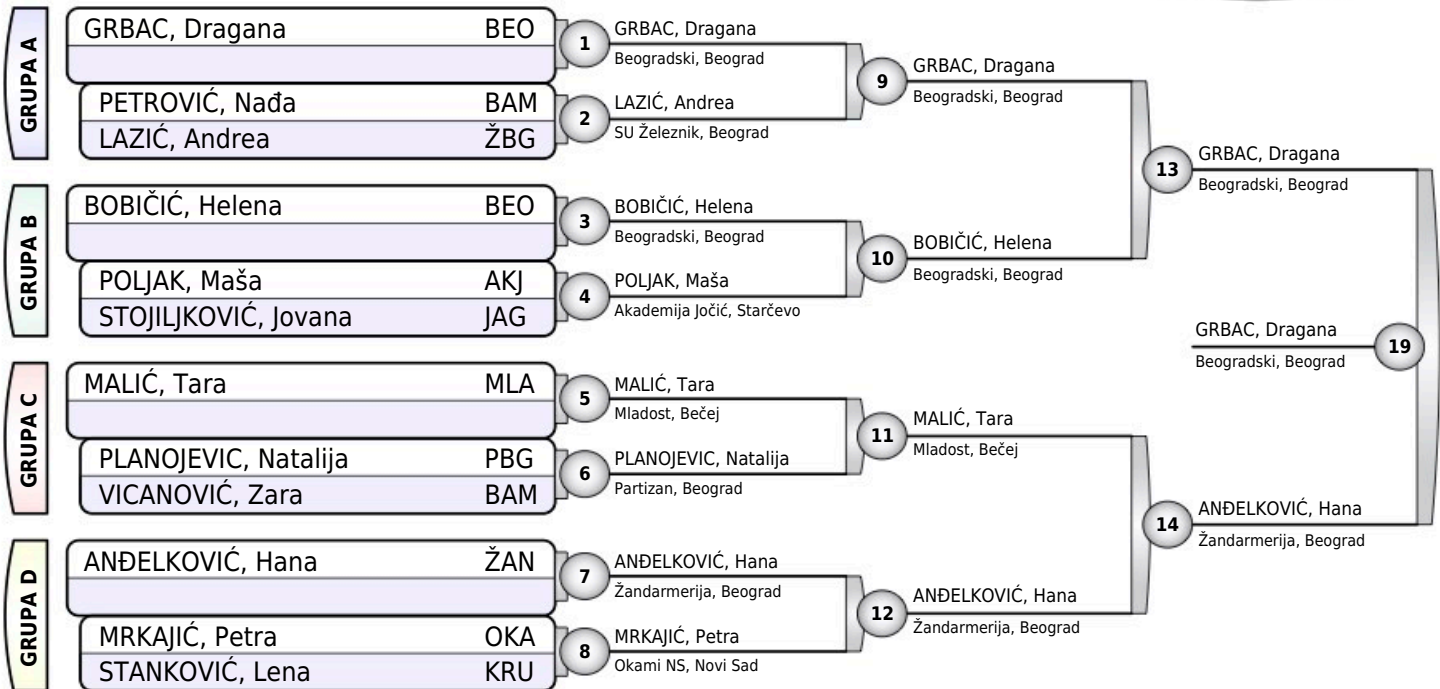

Rezultati

1. GRBAC, Dragana BEO
2. ANĐELKOVIĆ, Hana ŽAN
3. BOBIČIĆ, Helena BEO
3. MALIĆ, Tara MLA
5. LAZIĆ, Andrea ŽBG
5. MRKAJIĆ, Petra OKA
- 7.
- 7.

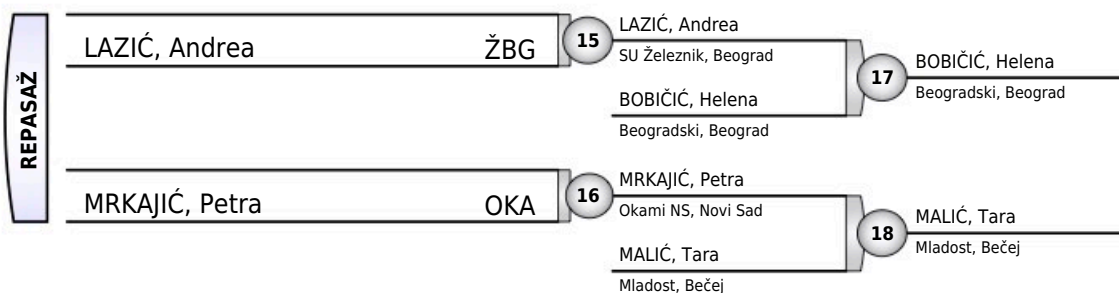



SREBRNO JEZERO 2026 I DAN

Veliko Gradište, 13.06.2026.

Starije poletarke

-34KG

11 takmičarki

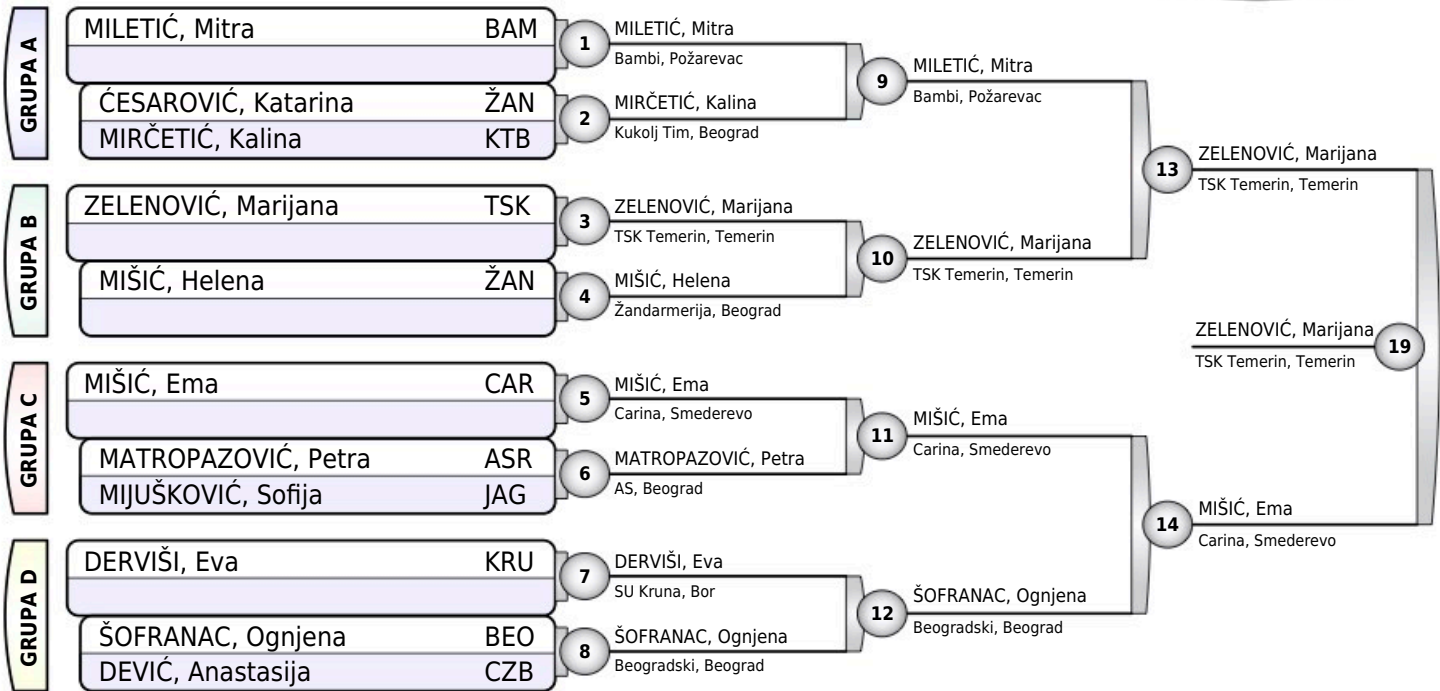

Rezultati

1. ZELENOVIĆ, Marijana TSK
2. MIŠIĆ, Ema CAR
3. MILETIĆ, Mitra BAM
3. ŠOFRANAC, Ognjena BEO
5. MIŠIĆ, Helena ŽAN
5. MATROPAZOVIĆ, Petra ASR
- 7.
- 7.

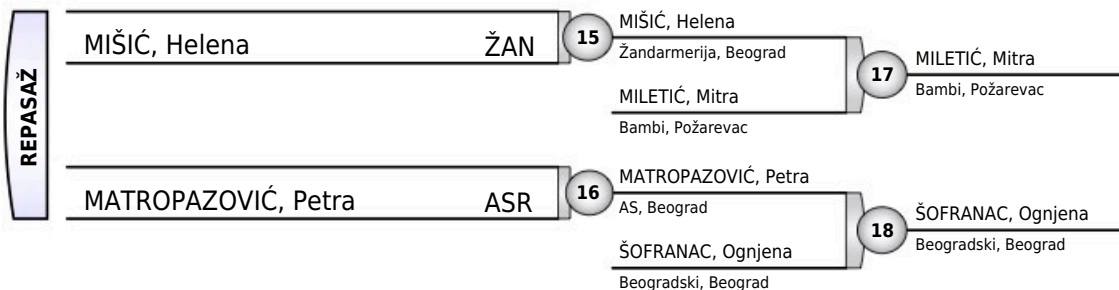



SREBRNO JEZERO 2026 I DAN

Veliko Gradište, 13.06.2026.

Starije poletarke

-38KG

10 takmičarki

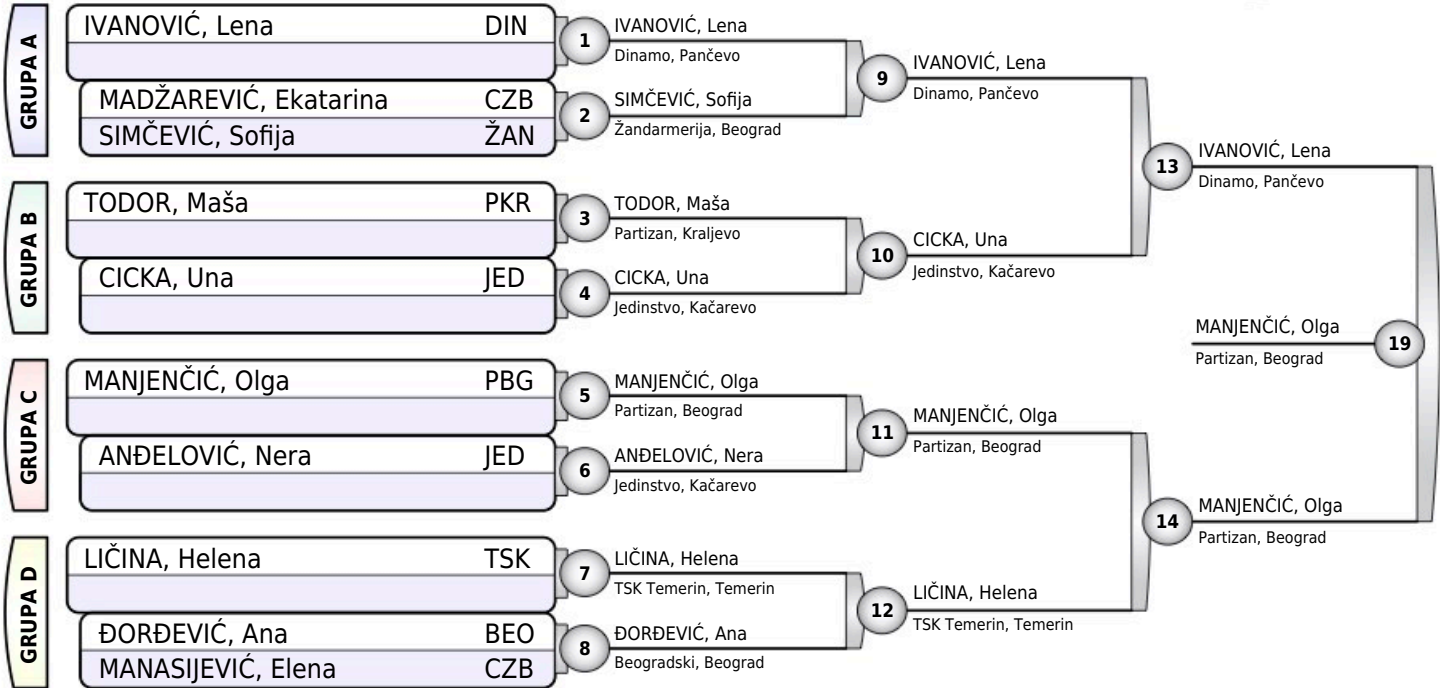

Rezultati

1. MANJENČIĆ, Olga PBG
2. IVANOVIĆ, Lena DIN
3. CICKA, Una JED
3. LIČINA, Helena TSK
5. SIMČEVIĆ, Sofija ŽAN
5. ANĐELOVIĆ, Nera JED
- 7.
- 7.





SREBRNO JEZERO 2026 I DAN

Veliko Gradište, 13.06.2026.

Starije poletarke

-43KG

6 takmičarki

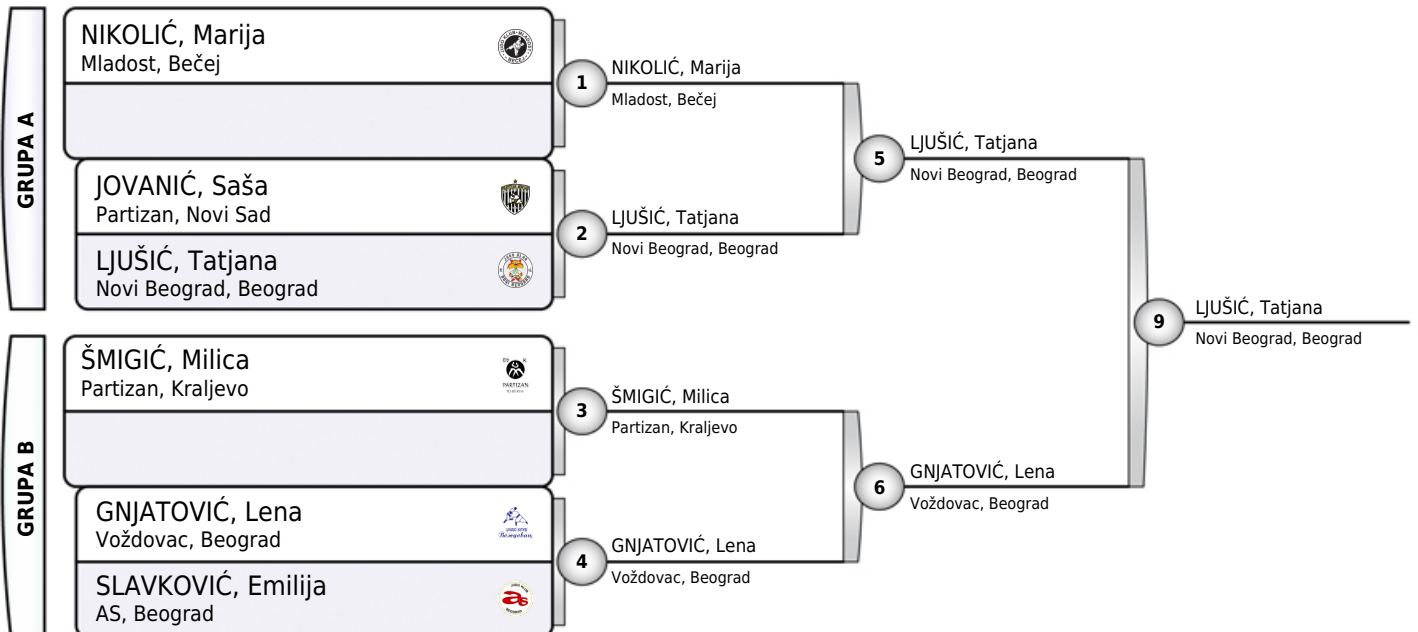

Rezultati

1. LJUŠIĆ, Tatjana NBG
2. GNJATOVIĆ, Lena VOŽ
3. JOVANIĆ, Saša PNS
3. ŠMIGIĆ, Milica PKR
5. NIKOLIĆ, Marija MLA
5. SLAVKOVIĆ, Emilija ASR
- 7.
- 7.

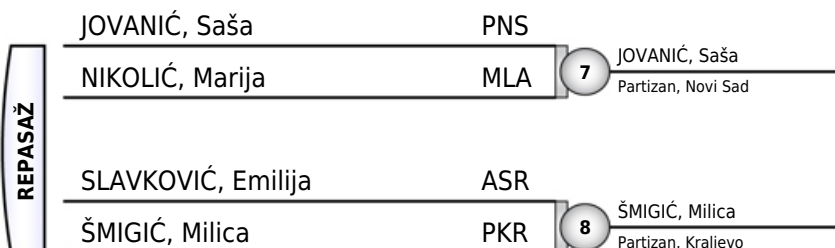



SREBRNO JEZERO 2026 I DAN

Veliko Gradište, 13.06.2026.

Starije poletarke

+43KG

10 takmičarki

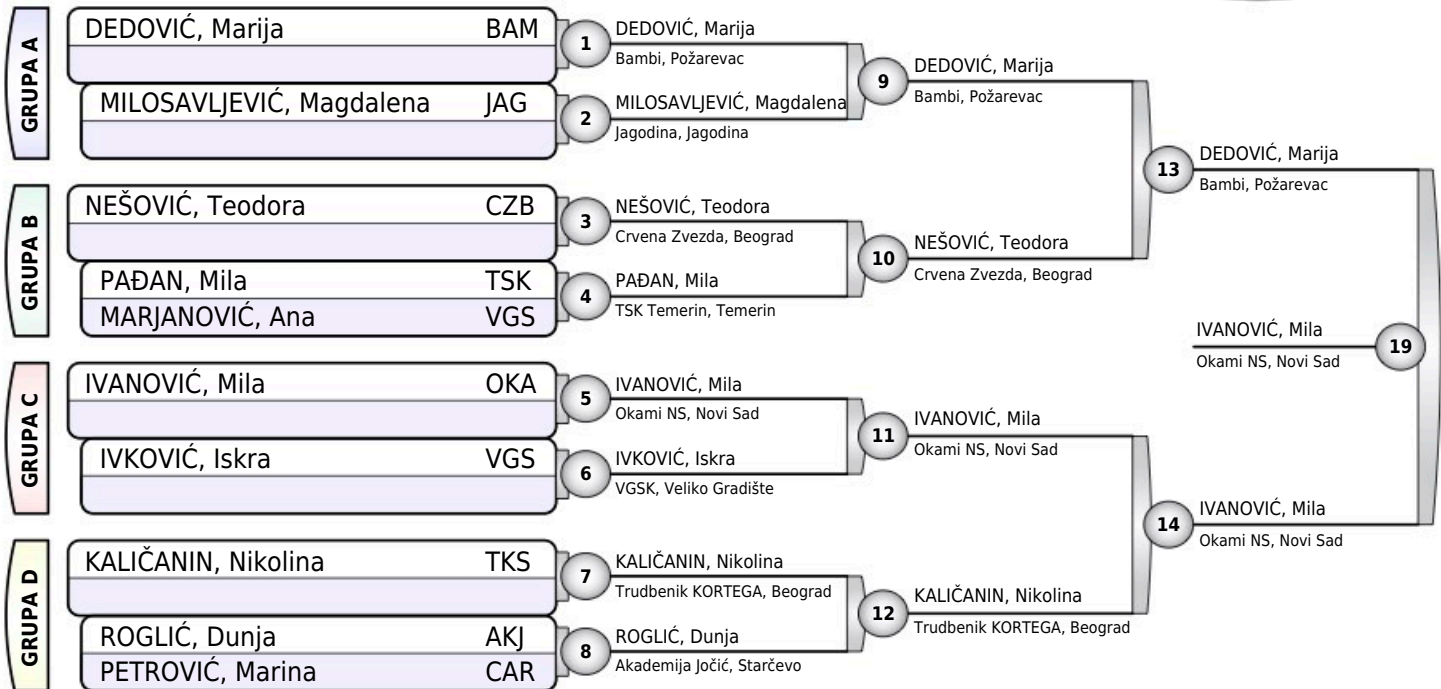

Rezultati

1. IVANOVIĆ, Mila OKA
2. DEDOVIĆ, Marija BAM
3. MILOSAVLJEVIĆ, Magdalena JAG
3. KALIČANIN, Nikolina TKS
5. NEŠOVIĆ, Teodora CZB
5. IVKOVIĆ, Iskra VGS
- 7.
- 7.

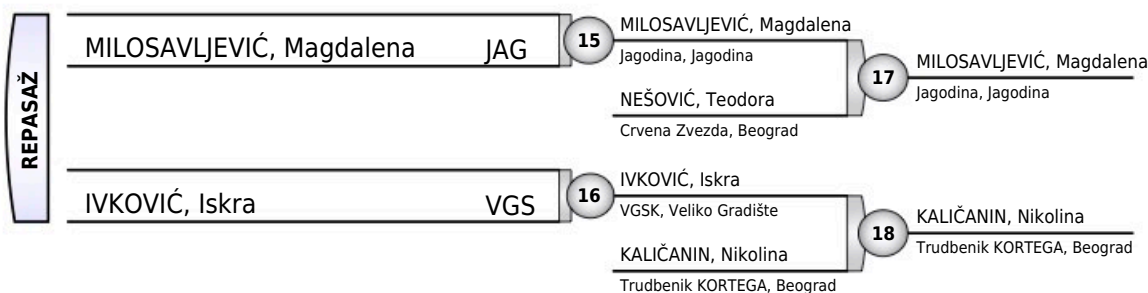



SREBRNO JEZERO 2026 I DAN

Veliko Gradište, 13.06.2026.

Stariji dečaci

-38KG

6 takmičara

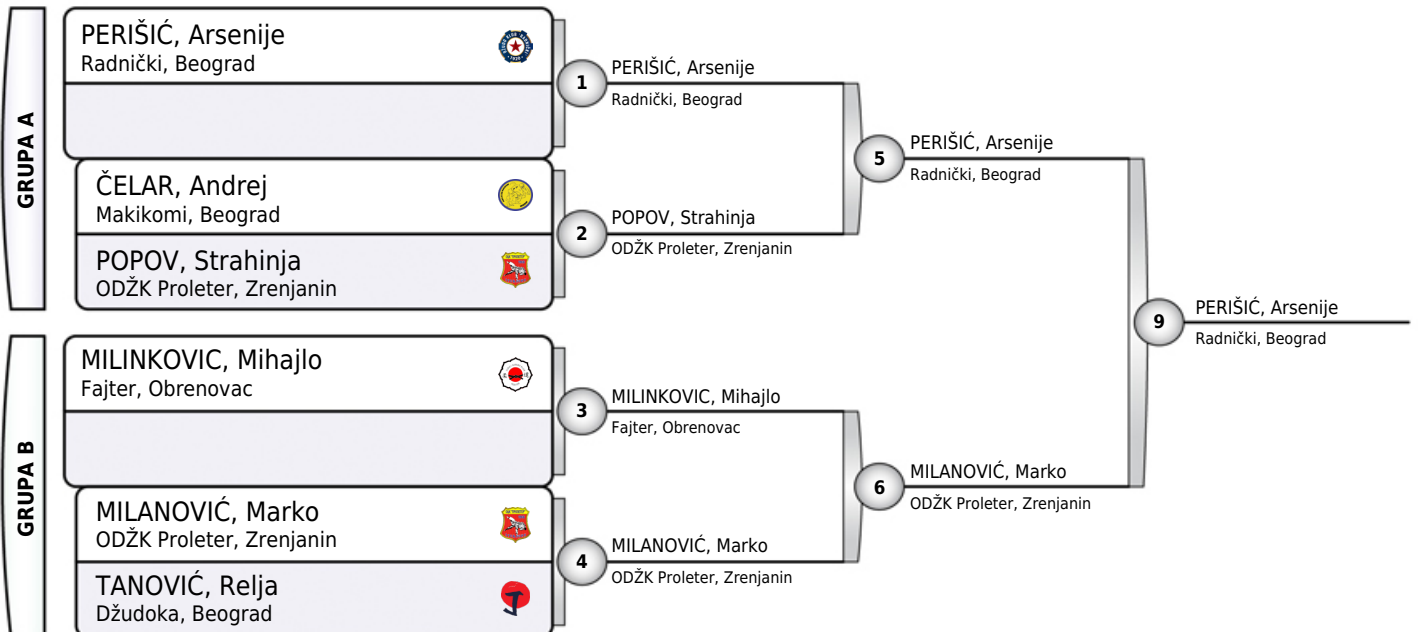

Rezultati

1. PERIŠIĆ, Arsenije RAD
2. MILANOVIĆ, Marko PRO
3. POPOV, Strahinja PRO
3. MILINKOVIC, Mihajlo FAJ
5. TANOVIĆ, Relja DKA
- 5.
- 7.
- 7.

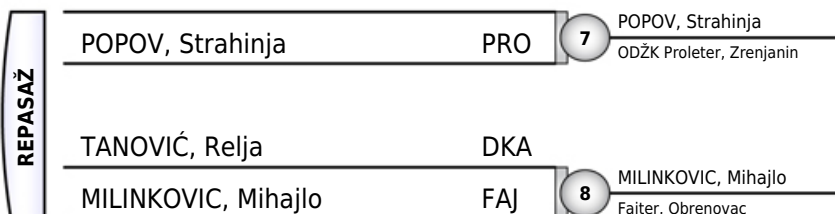



SREBRNO JEZERO 2026 I DAN

Veliko Gradište, 13.06.2026.

Stariji dečaci

-42KG

13 takmičara

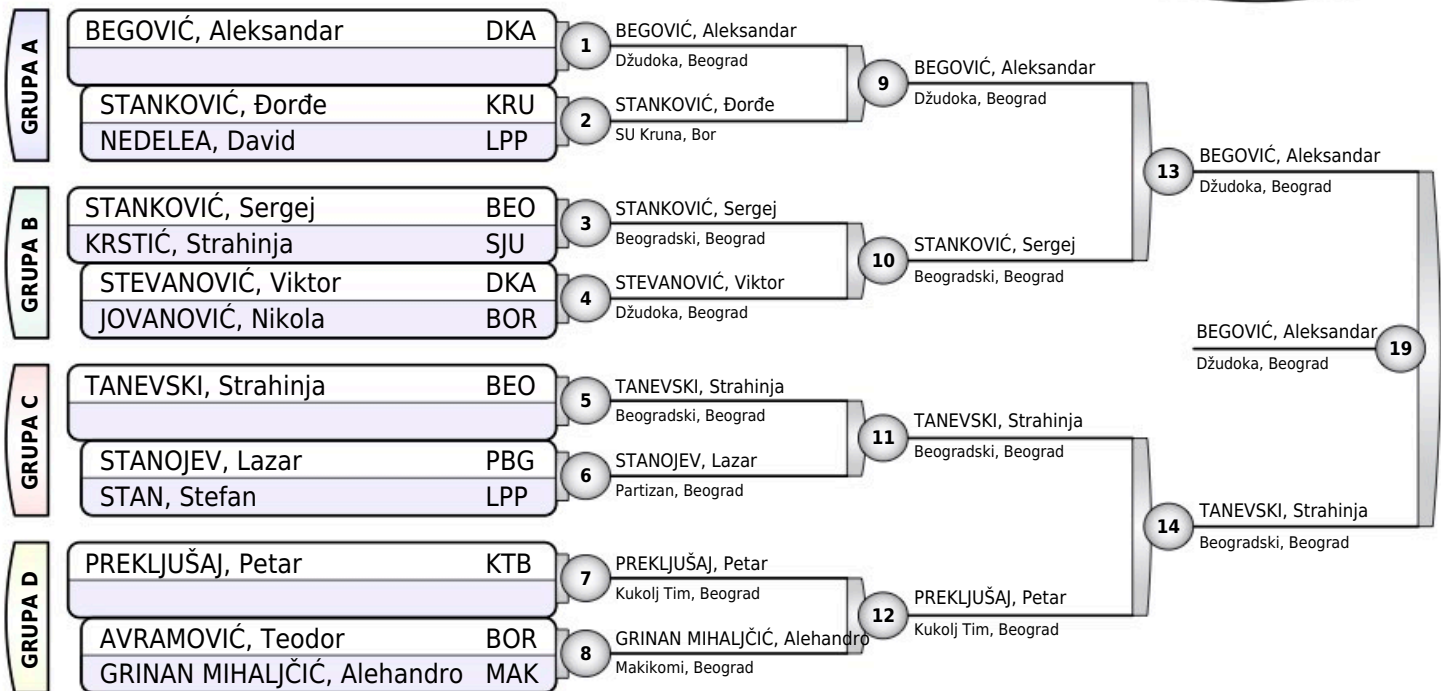

Rezultati

1. BEGOVIĆ, Aleksandar DKA
2. TANEVSKI, Strahinja BEO
3. STANKOVIĆ, Đorđe KRU
3. PREKLJUŠAJ, Petar KTB
5. STANKOVIĆ, Sergej BEO
5. STANOJEV, Lazar PBG
- 7.
- 7.

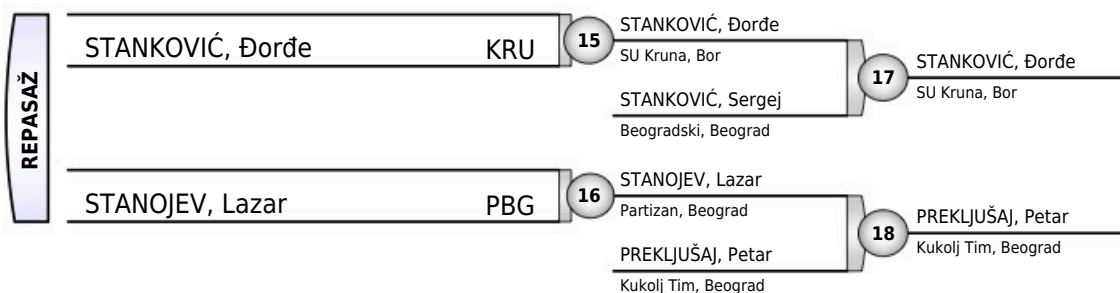



SREBRNO JEZERO 2026 I DAN

Veliko Gradište, 13.06.2026.

Stariji dečaci

-46KG

15 takmičara

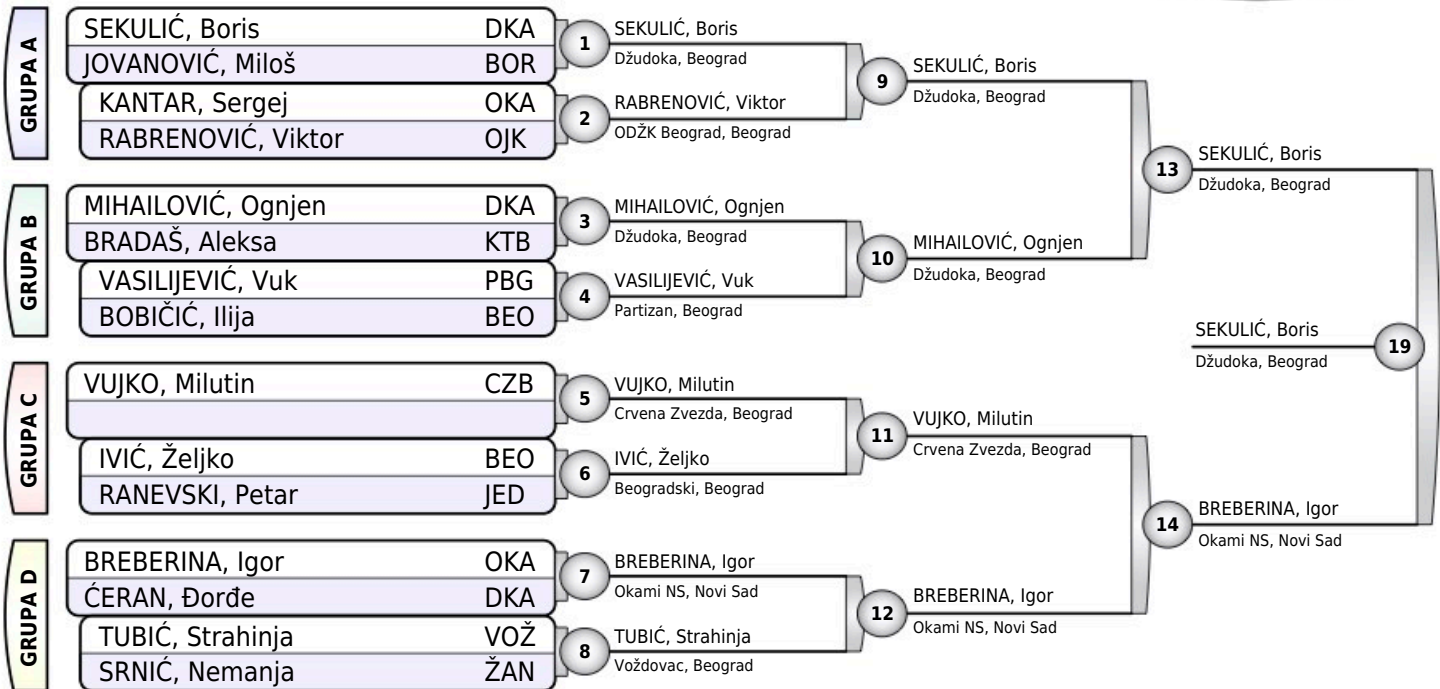

Rezultati

- | | | |
|----|--------------------|-----|
| 1. | SEKULIĆ, Boris | DKA |
| 2. | BREBERINA, Igor | OKA |
| 3. | MIHAILOVIĆ, Ognjen | DKA |
| 3. | VUJKO, Milutin | CZB |
| 5. | JOVANOVIĆ, Miloš | BOR |
| 5. | ĆERAN, Đorđe | DKA |
| 7. | RABRENOVIĆ, Viktor | OJK |
| 7. | TUBIĆ, Strahinja | VOŽ |

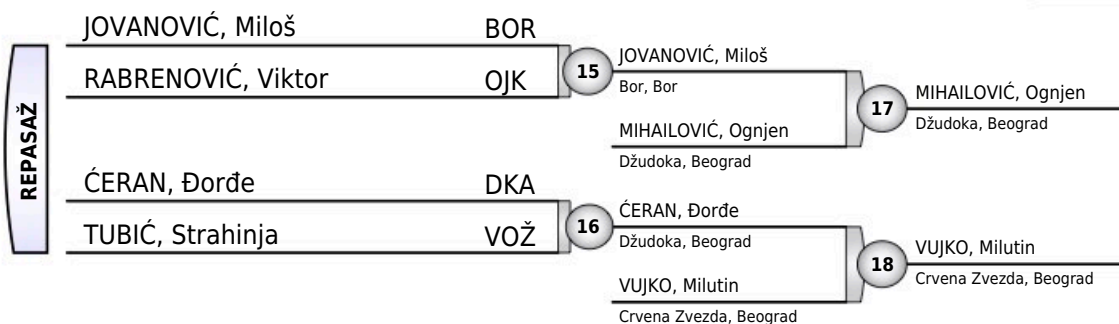



SREBRNO JEZERO 2026 I DAN

Veliko Gradište, 13.06.2026.

Stariji dečaci

-50KG

8 takmičara

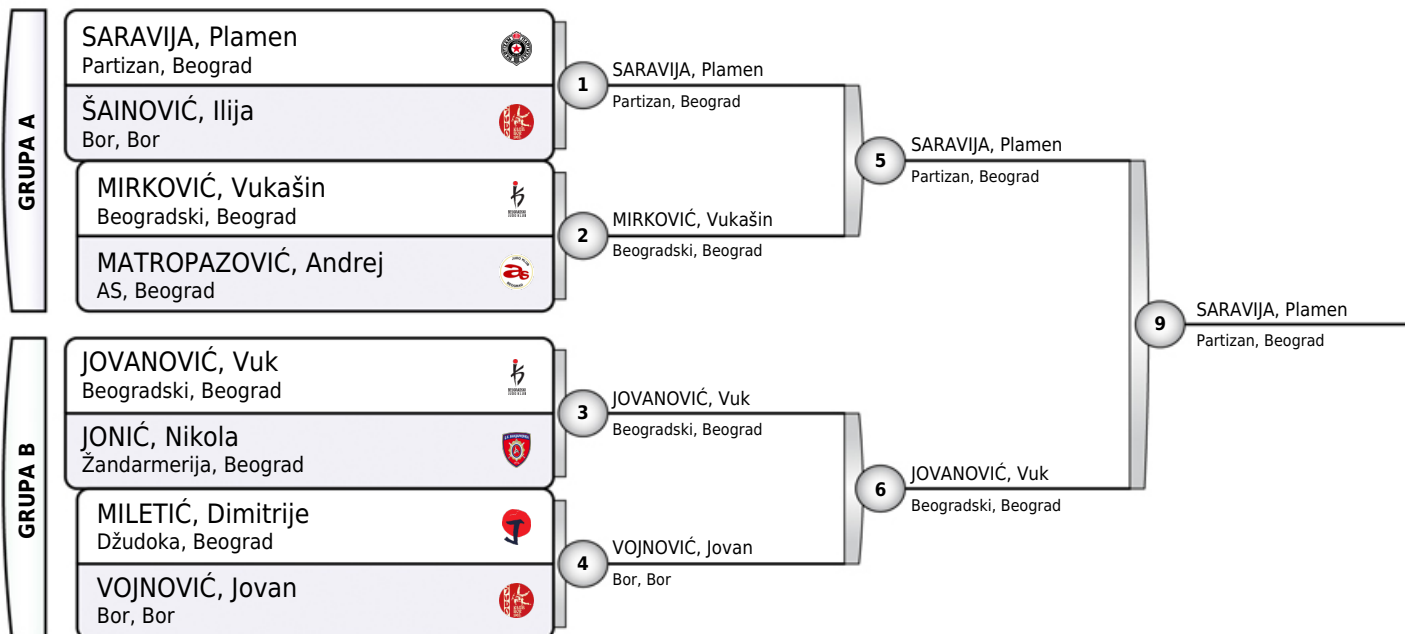

Rezultati

- | | | |
|----|-------------------|-----|
| 1. | SARAVIJA, Plamen | PBG |
| 2. | JOVANOVIĆ, Vuk | BEO |
| 3. | ŠAINOVIĆ, Ilija | BOR |
| 3. | VOJNOVIĆ, Jovan | BOR |
| 5. | MIRKOVIĆ, Vukašin | BEO |
| 5. | JONIĆ, Nikola | ŽAN |
| 7. | | |
| 7. | | |

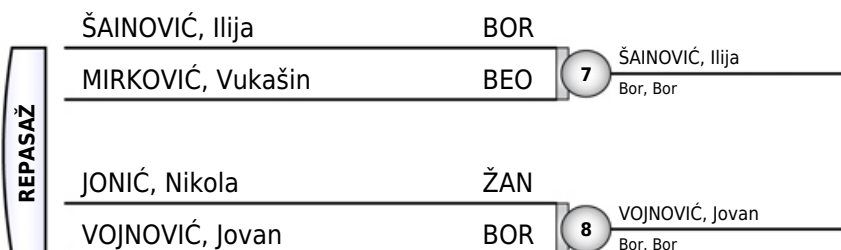



SREBRNO JEZERO 2026 I DAN

Veliko Gradište, 13.06.2026.

Stariji dečaci

-55KG

17 takmičara

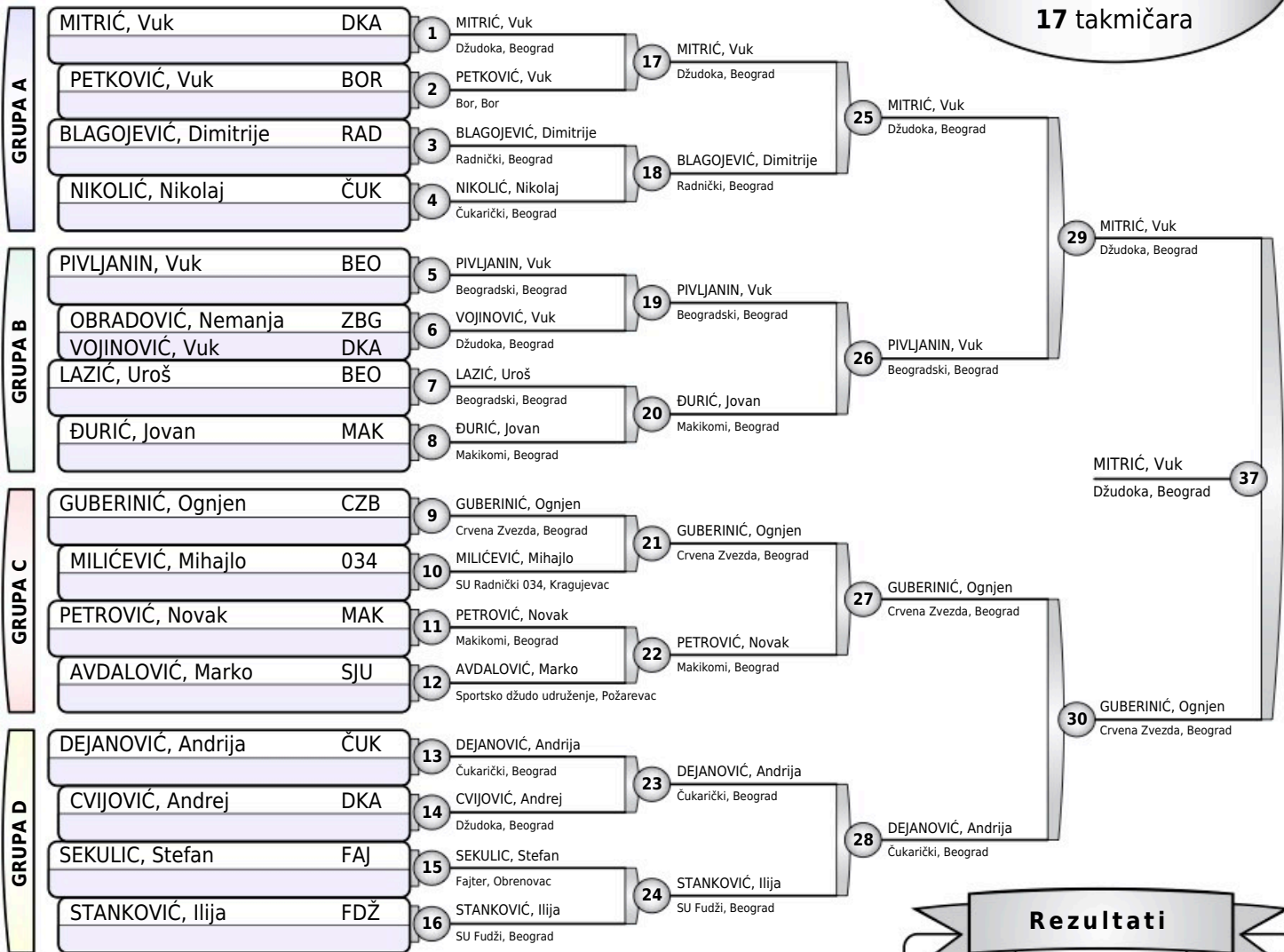

Rezultati

1. MITRIĆ, Vuk (DKA)
2. GUBERINIĆ, Ognjen (CZB)
3. PIVLJANIN, Vuk (BEO)
3. DEJANOVIĆ, Andrija (ČUK)
5. PETKOVIĆ, Vuk (BOR)
5. PETROVIĆ, Novak (MAK)
7. BLAGOJEVIĆ, Dimitrije (RAD)
7. MILIĆEVIĆ, Mihajlo (034)



SREBRNO JEZERO 2026 I DAN

Veliko Gradište, 13.06.2026.

Stariji dečaci

-60KG

10 takmičara

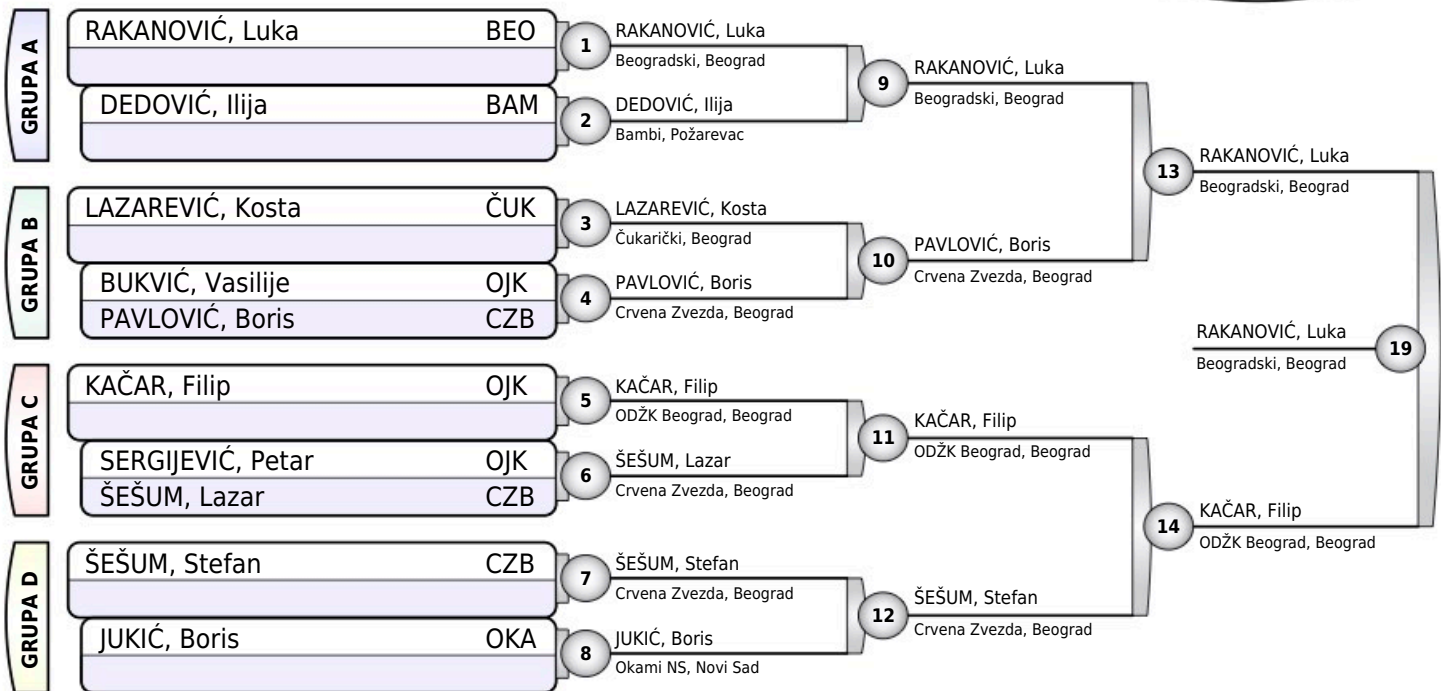

Rezultati

1. RAKANOVIĆ, Luka BEO
2. KAČAR, Filip OJK
3. PAVLOVIĆ, Boris CZB
3. ŠEŠUM, Stefan CZB
5. DEDOVIĆ, Ilija BAM
5. ŠEŠUM, Lazar CZB
- 7.
- 7.

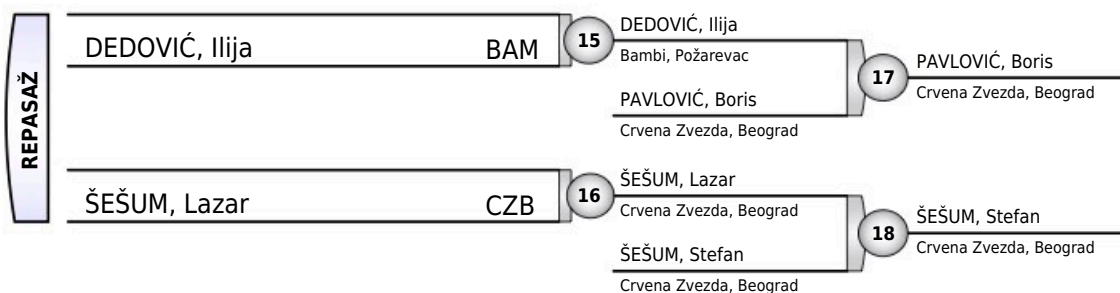



SREBRNO JEZERO 2026 I DAN

Veliko Gradište, 13.06.2026.

Stariji dečaci

-66KG

9 takmičara

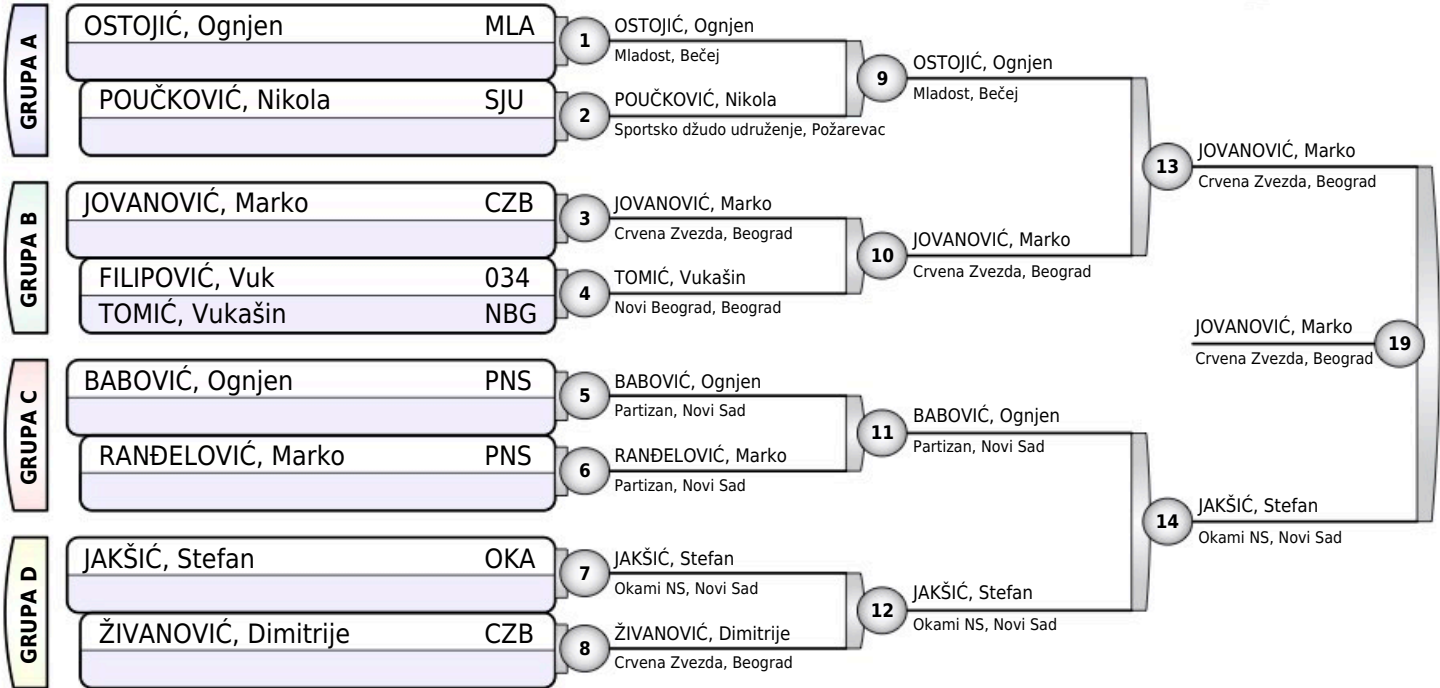

Rezultati

1. JOVANOVIĆ, Marko CZB
2. JAKŠIĆ, Stefan OKA
3. OSTOJIĆ, Ognjen MLA
3. BABOVIĆ, Ognjen PNS
5. TOMIĆ, Vukašin NBG
5. ŽIVANOVIĆ, Dimitrije CZB
- 7.
- 7.

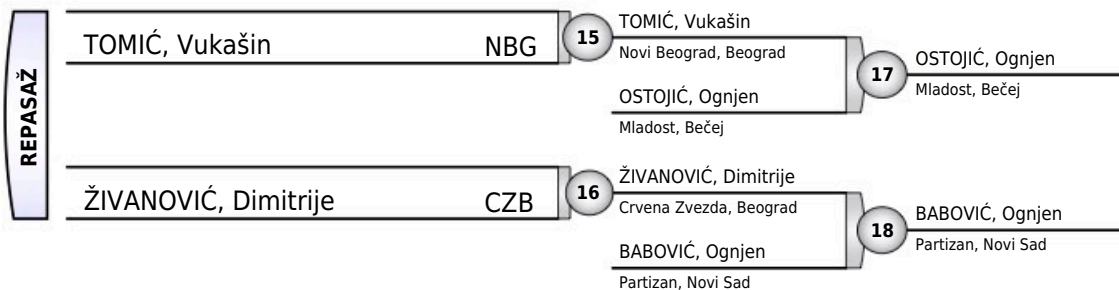



SREBRNO JEZERO 2026 I DAN

Veliko Gradište, 13.06.2026.

Stariji dečaci

-73KG

7 takmičara

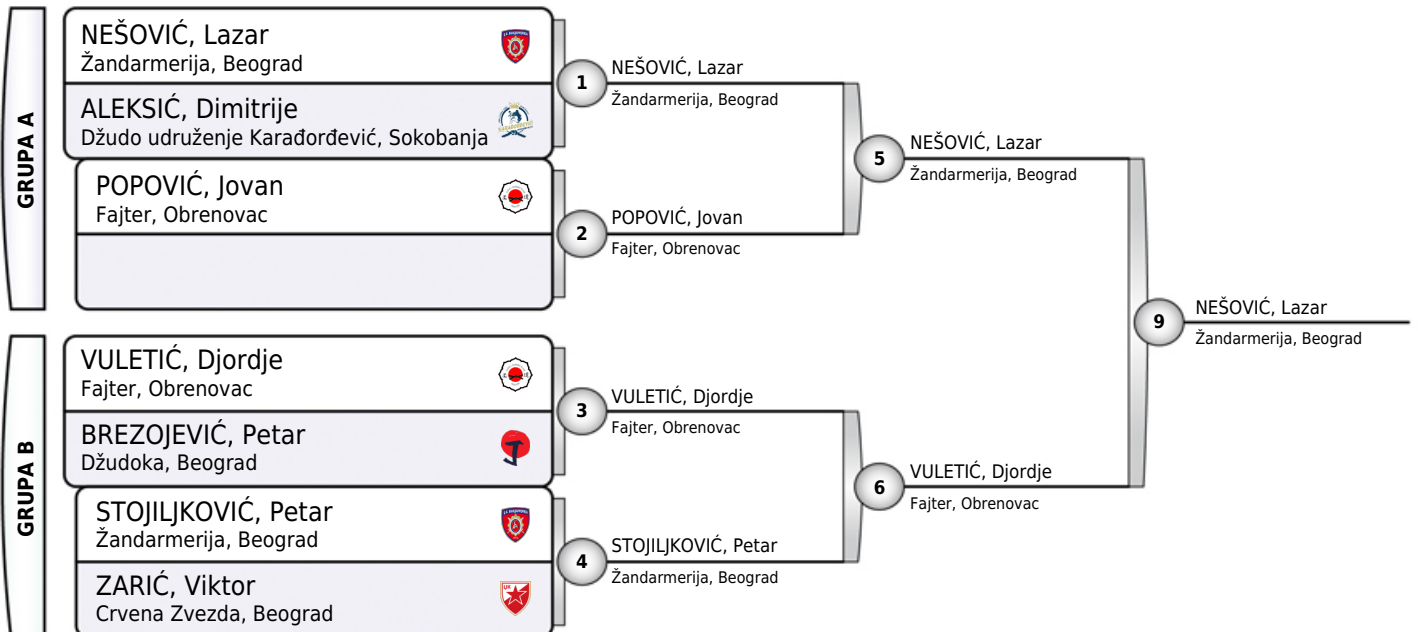

Rezultati

1. NEŠOVIĆ, Lazar ŽAN
2. VULETIĆ, Djordje FAJ
3. ALEKSIĆ, Dimitrije KAR
3. STOJILJKOVIĆ, Petar ŽAN
5. POPOVIĆ, Jovan FAJ
5. BREZOJEVIĆ, Petar DKA
- 7.
- 7.

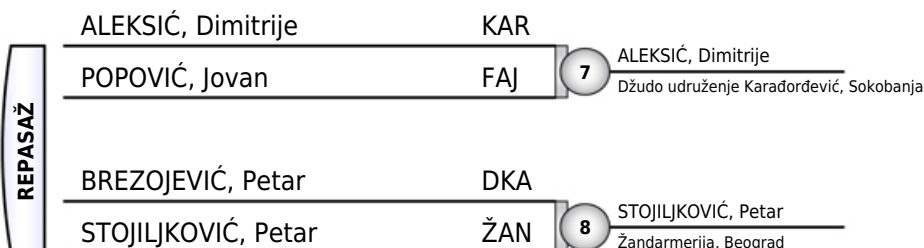



SREBRNO JEZERO 2026 I DAN

Veliko Gradište, 13.06.2026.

Stariji dečaci

+73KG

4 takmičara

| Takmičar i klub | 1 | 2 | 3 | 4 | Pobeda | Bodova | Mesto |
|--|-----|---|-----|-----|--------|--------|-------|
| 1 IVIĆ, Viktor Sportsko džudo udruženje, Požarevac | | 0 | 0 | 0 | 0 | 0 | 3 |
| 2 JELIĆ, Aleksa Borac, Čačak | 100 | | 100 | 100 | 3 | 300 | 1 |
| 3 HAVAJIĆ, Dimitrije Zemun, Beograd | 100 | 0 | | 100 | 2 | 200 | 2 |
| 4 CVETKOVIĆ, Ognjen Župa Aleksandrovac, Aleksandrovac | 100 | 0 | 0 | | 1 | 100 | 3 |

| | | | |
|--------------------|-----|---|-----------------------------------|
| IVIĆ, Viktor | SJU | 1 | JELIĆ, Aleksa |
| JELIĆ, Aleksa | BČA | | Borac, Čačak |
| HAVAJIĆ, Dimitrije | ZEM | 2 | HAVAJIĆ, Dimitrije |
| CVETKOVIĆ, Ognjen | ŽAL | | Zemun, Beograd |
| IVIĆ, Viktor | SJU | 3 | HAVAJIĆ, Dimitrije |
| HAVAJIĆ, Dimitrije | ZEM | | Zemun, Beograd |
| JELIĆ, Aleksa | BČA | 4 | JELIĆ, Aleksa |
| CVETKOVIĆ, Ognjen | ŽAL | | Borac, Čačak |
| IVIĆ, Viktor | SJU | 5 | CVETKOVIĆ, Ognjen |
| CVETKOVIĆ, Ognjen | ŽAL | | Župa Aleksandrovac, Aleksandrovac |
| JELIĆ, Aleksa | BČA | 6 | JELIĆ, Aleksa |
| HAVAJIĆ, Dimitrije | ZEM | | Borac, Čačak |

Rezultati

- | | |
|-----------------------|-----|
| 1. JELIĆ, Aleksa | BČA |
| 2. HAVAJIĆ, Dimitrije | ZEM |
| 3. CVETKOVIĆ, Ognjen | ŽAL |
| 3. IVIĆ, Viktor | SJU |



SREBRNO JEZERO 2026 I DAN

Veliko Gradište, 13.06.2026.

Starije devojčice

-36KG

2 takmičarke

| | | | |
|--------------------|-----|---|-------------------|
| STANČIĆ, Valentina | PRO | 1 | NIKOLOSKA, Mateja |
| NIKOLOSKA, Mateja | SEI | | SEISHIN, Prilep |
| STANČIĆ, Valentina | PRO | 2 | NIKOLOSKA, Mateja |
| NIKOLOSKA, Mateja | SEI | | SEISHIN, Prilep |
| STANČIĆ, Valentina | PRO | 3 | |
| NIKOLOSKA, Mateja | SEI | | |

Rezultati

1. NIKOLOSKA, Mateja SEI
2. STANČIĆ, Valentina PRO



SREBRNO JEZERO 2026 I DAN

Veliko Gradište, 13.06.2026.

Starije devojčice

-40KG

2 takmičarke

| | | | |
|-------------------------|-----|---|---|
| DIMITRIJEVSKI, Hristina | DIN | 1 | USAINOVIĆ, Helena |
| USAINOVIĆ, Helena | KAR | | Džudo udruženje Karađorđević, Sokobanja |
| DIMITRIJEVSKI, Hristina | DIN | 2 | USAINOVIĆ, Helena |
| USAINOVIĆ, Helena | KAR | | Džudo udruženje Karađorđević, Sokobanja |
| DIMITRIJEVSKI, Hristina | DIN | 3 | |
| USAINOVIĆ, Helena | KAR | | |

Rezultati

1. USAINOVIĆ, Helena KAR
2. DIMITRIJEVSKI, Hristina DIN



SREBRNO JEZERO 2026 I DAN

Veliko Gradište, 13.06.2026.

Starije devojčice

-44KG

3 takmičarke

| Takmičar i klub | 1 | 2 | 3 | Pobeda | Bodova | Mesto |
|--|---|-----|-----|--------|--------|-------|
| 1 KNEZOVIĆ, Nina Beogradski, Beograd | | 100 | 100 | 2 | 200 | 1 |
| 2 KISIĆ, Marina Partizan, Beograd | 0 | | 100 | 1 | 100 | 2 |
| 3 ČOČIĆ, Nikolina Župa Aleksandrovac, Aleksandrovac | 0 | 0 | | 0 | 0 | 3 |

| | | | |
|-----------------|-----|---|---------------------|
| KNEZOVIĆ, Nina | BEO | 1 | KNEZOVIĆ, Nina |
| KISIĆ, Marina | PBG | | Beogradski, Beograd |
| KNEZOVIĆ, Nina | BEO | 2 | KNEZOVIĆ, Nina |
| ČOČIĆ, Nikolina | ŽAL | | Beogradski, Beograd |
| KISIĆ, Marina | PBG | 3 | KISIĆ, Marina |
| ČOČIĆ, Nikolina | ŽAL | | Partizan, Beograd |

Rezultati

1. KNEZOVIĆ, Nina BEO
2. KISIĆ, Marina PBG
3. ČOČIĆ, Nikolina ŽAL



SREBRNO JEZERO 2026 I DAN

Veliko Gradište, 13.06.2026.

Starije devojčice

-48KG

5 takmičarki

| Takmičar i klub | 1 | 2 | 3 | 4 | 5 | Pobeda | Bodova | Mesto |
|--|-----|---|-----|-----|-----|--------|--------|-------|
| 1 CVETKOSKA, Jovana SEISHIN, Prilep | | 0 | 0 | 0 | 0 | 0 | 0 | 5 |
| 2 IVANOVIĆ, Lena Okami NS, Novi Sad | 100 | | 100 | 100 | 100 | 4 | 400 | 1 |
| 3 ZDRAVKOVIĆ, Neva Čukarički, Beograd | 100 | 0 | | 1 | 0 | 2 | 101 | 3 |
| 4 MILISAVLJEVIĆ, Emilija Crvena Zvezda, Beograd | 100 | 0 | 0 | | 0 | 1 | 100 | 3 |
| 5 GRUBJEŠIĆ, Nina Partizan, Beograd | 10 | 0 | 100 | 100 | | 3 | 210 | 2 |

| | | |
|----------------------------|----|------------------------|
| CVETKOSKA, Jovana SEI | 1 | IVANOVIĆ, Lena |
| IVANOVIĆ, Lena OKA | | Okami NS, Novi Sad |
| ZDRAVKOVIĆ, Neva ČUK | 2 | ZDRAVKOVIĆ, Neva |
| MILISAVLJEVIĆ, Emilija CZB | | Čukarički, Beograd |
| CVETKOSKA, Jovana SEI | 3 | GRUBJEŠIĆ, Nina |
| GRUBJEŠIĆ, Nina PBG | | Partizan, Beograd |
| IVANOVIĆ, Lena OKA | 4 | IVANOVIĆ, Lena |
| ZDRAVKOVIĆ, Neva ČUK | | Okami NS, Novi Sad |
| MILISAVLJEVIĆ, Emilija CZB | 5 | GRUBJEŠIĆ, Nina |
| GRUBJEŠIĆ, Nina PBG | | Partizan, Beograd |
| CVETKOSKA, Jovana SEI | 6 | ZDRAVKOVIĆ, Neva |
| ZDRAVKOVIĆ, Neva ČUK | | Čukarički, Beograd |
| IVANOVIĆ, Lena OKA | 7 | IVANOVIĆ, Lena |
| MILISAVLJEVIĆ, Emilija CZB | | Okami NS, Novi Sad |
| ZDRAVKOVIĆ, Neva ČUK | 8 | GRUBJEŠIĆ, Nina |
| GRUBJEŠIĆ, Nina PBG | | Partizan, Beograd |
| CVETKOSKA, Jovana SEI | 9 | MILISAVLJEVIĆ, Emilija |
| MILISAVLJEVIĆ, Emilija CZB | | Crvena Zvezda, Beograd |
| IVANOVIĆ, Lena OKA | 10 | IVANOVIĆ, Lena |
| GRUBJEŠIĆ, Nina PBG | | Okami NS, Novi Sad |

Rezultati

- | | |
|---------------------------|-----|
| 1. IVANOVIĆ, Lena | OKA |
| 2. GRUBJEŠIĆ, Nina | PBG |
| 3. ZDRAVKOVIĆ, Neva | ČUK |
| 3. MILISAVLJEVIĆ, Emilija | CZB |
| 5. CVETKOSKA, Jovana | SEI |



SREBRNO JEZERO 2026 I DAN

Veliko Gradište, 13.06.2026.

Starije devojčice

-52KG

7 takmičarki

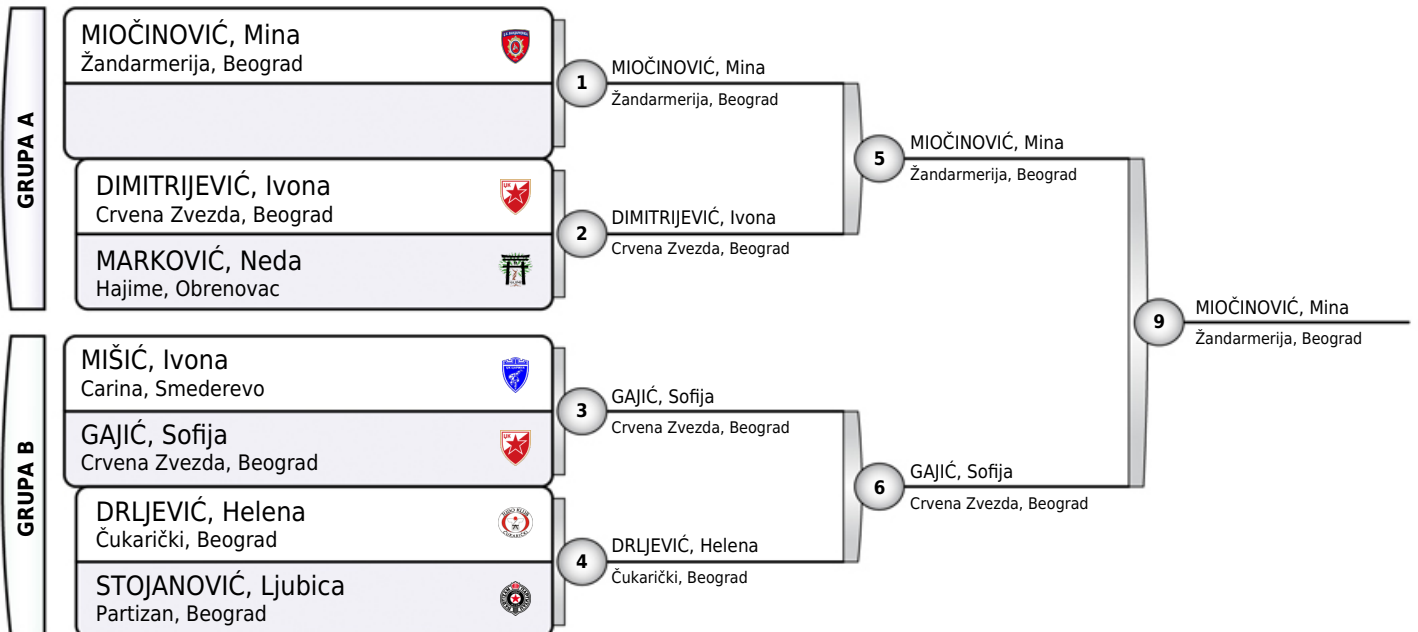

Rezultati

1. MIOČINOVIĆ, Mina ŽAN
2. GAJIĆ, Sofija CZB
3. DIMITRIJEVIĆ, Ivona CZB
3. MIŠIĆ, Ivona CAR
5. DRLJEVIĆ, Helena ČUK
- 5.
- 7.
- 7.

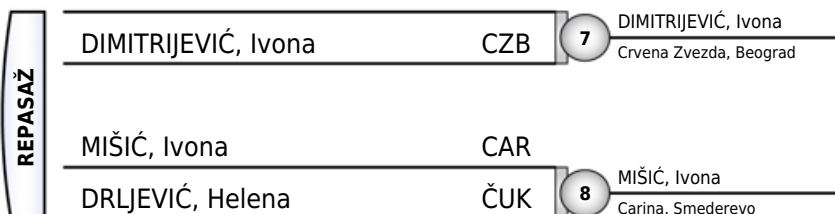



SREBRNO JEZERO 2026 I DAN

Veliko Gradište, 13.06.2026.

Starije devojčice

-57KG

14 takmičarki

| GRUPA | Ime | Škola | Redni broj | Ime | Škola | Redni broj | Ime | Škola | Redni broj |
|---------|--------------------|-------|------------|-------------------|-----------------------------|------------|-------------------|------------------------|------------|
| GRUPA A | BENIŠEK, Dora | BEO | 1 | BENIŠEK, Dora | Beogradski, Beograd | 9 | BENIŠEK, Dora | Beogradski, Beograd | 13 |
| | KORAĆ, Iva | KTB | 2 | KORAĆ, Iva | Kukolj Tim, Beograd | 10 | MILENKOVIĆ, Minja | 13. maj, Ub | 19 |
| | ĐAJIĆ, Teodora | BEO | 3 | MILOŠEVIĆ, Lena | VGSK, Veliko Gradište | 11 | KOSTIC, Mila | Fajter, Obrenovac | 14 |
| GRUPA B | MILOŠEVIĆ, Lena | VGS | 3 | MILOŠEVIĆ, Lena | VGSK, Veliko Gradište | 10 | MILENKOVIĆ, Minja | 13. maj, Ub | 19 |
| | ŠOŠO, Manja | VIN | 4 | MILENKOVIĆ, Minja | 13. maj, Ub | 11 | KOSTIC, Mila | Fajter, Obrenovac | 14 |
| | MILENKOVIĆ, Minja | 13U | 4 | MILENKOVIĆ, Minja | 13. maj, Ub | 12 | VIGNJEVIĆ, Una | Crvena Zvezda, Beograd | 19 |
| GRUPA C | KOSTIC, Mila | FAJ | 5 | KOSTIC, Mila | Fajter, Obrenovac | 11 | KOSTIC, Mila | Fajter, Obrenovac | 14 |
| | NAUMOV, Sofija | 034 | 6 | NAUMOV, Sofija | SU Radnički 034, Kragujevac | 12 | VIGNJEVIĆ, Una | Crvena Zvezda, Beograd | 19 |
| | MIŠIĆ, Andrijana | VIN | 6 | NAUMOV, Sofija | SU Radnički 034, Kragujevac | 12 | VIGNJEVIĆ, Una | Crvena Zvezda, Beograd | 19 |
| GRUPA D | VIGNJEVIĆ, Una | CZB | 7 | VIGNJEVIĆ, Una | Crvena Zvezda, Beograd | 12 | VIGNJEVIĆ, Una | Crvena Zvezda, Beograd | 19 |
| | SRETENOVIĆ, Bojana | VGS | 7 | VIGNJEVIĆ, Una | Crvena Zvezda, Beograd | 12 | VIGNJEVIĆ, Una | Crvena Zvezda, Beograd | 19 |
| | NASTIĆ, Teodora | BEO | 8 | NASTIĆ, Teodora | Beogradski, Beograd | 17 | NASTIĆ, Teodora | Beogradski, Beograd | 18 |
| | ZEKIĆ, Đurđa | KTB | 8 | NASTIĆ, Teodora | Beogradski, Beograd | 17 | NASTIĆ, Teodora | Beogradski, Beograd | 18 |

Rezultati

1. BENIŠEK, Dora BEO
2. VIGNJEVIĆ, Una CZB
3. KORAĆ, Iva KTB
3. NASTIĆ, Teodora BEO
5. MILENKOVIĆ, Minja 13U
5. KOSTIC, Mila FAJ
7. SRETENOVIĆ, Bojana VGS
- 7.

| REPASAŽ | Ime | Škola | Redni broj | Ime | Škola | Redni broj |
|---------|--------------------|-------|------------|-------------------|---------------------|------------|
| | KORAĆ, Iva | KTB | 15 | KORAĆ, Iva | Kukolj Tim, Beograd | 17 |
| | MILENKOVIĆ, Minja | | | MILENKOVIĆ, Minja | Kukolj Tim, Beograd | 17 |
| | SRETENOVIĆ, Bojana | VGS | | NASTIĆ, Teodora | Beogradski, Beograd | 16 |
| | NASTIĆ, Teodora | BEO | 16 | NASTIĆ, Teodora | Beogradski, Beograd | 18 |
| | | | | KOSTIC, Mila | Fajter, Obrenovac | 18 |



SREBRNO JEZERO 2026 I DAN

Veliko Gradište, 13.06.2026.

Starije devojčice

-63KG

7 takmičarki

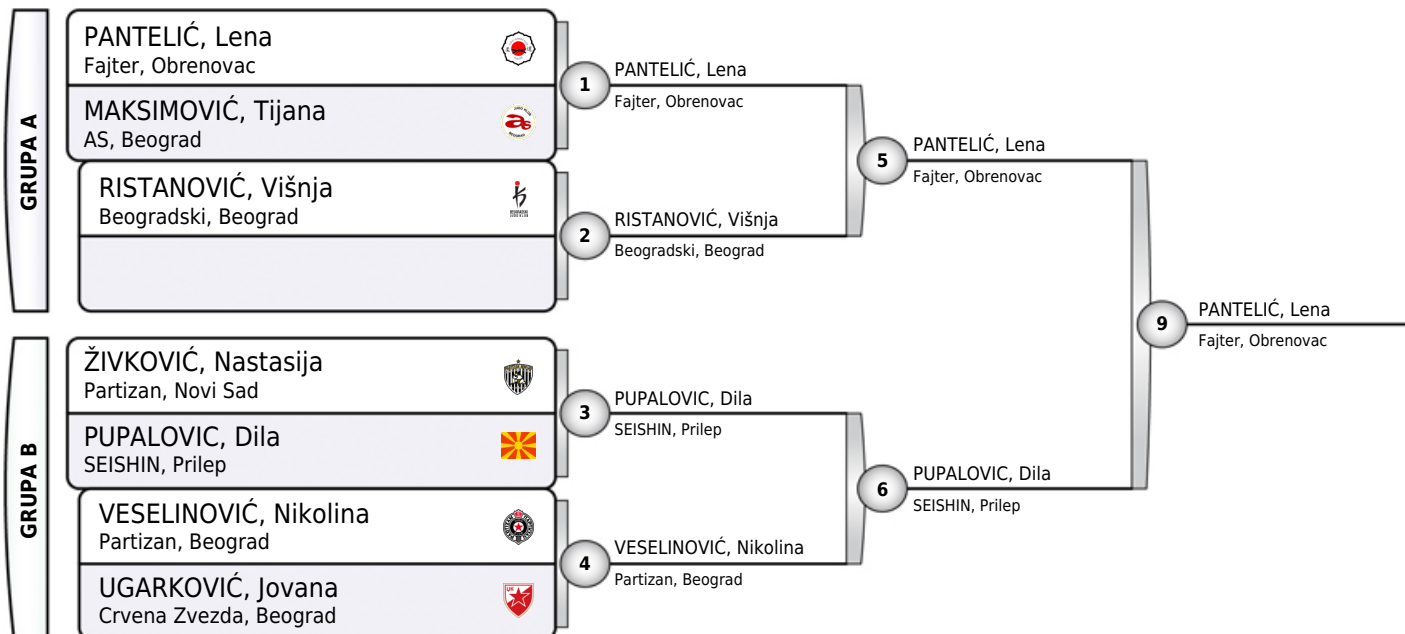

Rezultati

1. PANTELIĆ, Lena FAJ
2. PUPALOVIC, Dila SEI
3. RISTANOVIĆ, Višnja BEO
3. ŽIVKOVIĆ, Nastasija PNS
5. MAKSIMOVIĆ, Tijana ASR
5. VESELINOVIĆ, Nikolina PBG
- 7.
- 7.





SREBRNO JEZERO 2026 I DAN

Veliko Gradište, 13.06.2026.

Starije devojčice

+63KG

3 takmičarke

| Takmičar i klub | 1 | 2 | 3 | Pobeda | Bodova | Mesto |
|---|-----|---|-----|--------|--------|-------|
| 1 BLAGOJEVIĆ, Tara VGSK, Veliko Gradište | | 0 | 0 | 0 | 0 | 3 |
| 2 MILOVANOVIĆ, Emilija Žandarmerija, Beograd | 100 | | 100 | 2 | 200 | 1 |
| 3 MEHMEDOVIĆ, Nikolina Beogradski, Beograd | 100 | 0 | | 1 | 100 | 2 |

| | | | |
|----------------------|-----|---|-----------------------|
| BLAGOJEVIĆ, Tara | VGS | 1 | MILOVANOVIĆ, Emilija |
| MILOVANOVIĆ, Emilija | ŽAN | | Žandarmerija, Beograd |
| BLAGOJEVIĆ, Tara | VGS | 2 | MEHMEDOVIĆ, Nikolina |
| MEHMEDOVIĆ, Nikolina | BEO | | Beogradski, Beograd |
| MILOVANOVIĆ, Emilija | ŽAN | 3 | MILOVANOVIĆ, Emilija |
| MEHMEDOVIĆ, Nikolina | BEO | | Žandarmerija, Beograd |

Rezultati

1. MILOVANOVIĆ, Emilija ŽAN
2. MEHMEDOVIĆ, Nikolina BEO
3. BLAGOJEVIĆ, Tara VGS



SREBRNO JEZERO 2026 I DAN

Veliko Gradište, 13.06.2026.

Kadeti

-55KG

2 takmičara

| | | | |
|------------------|-----|---|---|
| ANĐELOVIĆ, Ilija | JED | 1 | ANĐELOVIĆ, Ilija Jedinstvo, Kačarevo |
| BOJČIĆ, Đorđe | RAD | | |
| ANĐELOVIĆ, Ilija | JED | 2 | ANĐELOVIĆ, Ilija Jedinstvo, Kačarevo |
| BOJČIĆ, Đorđe | RAD | | |
| ANĐELOVIĆ, Ilija | JED | 3 | |
| BOJČIĆ, Đorđe | RAD | | |

Rezultati

1. ANĐELOVIĆ, Ilija JED
2. BOJČIĆ, Đorđe RAD



SREBRNO JEZERO 2026 I DAN

Veliko Gradište, 13.06.2026.

Kadeti

-60KG

6 takmičara

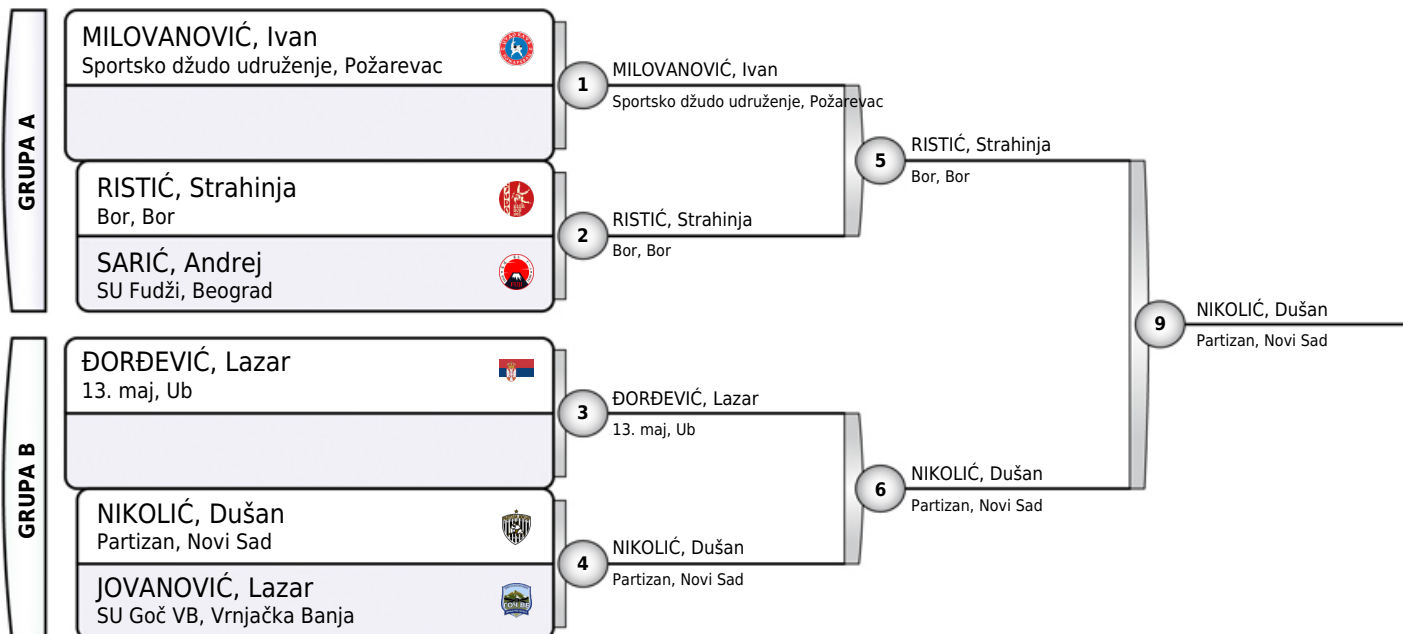

Rezultati

- | | |
|----------------------|-----|
| 1. NIKOLIĆ, Dušan | PNS |
| 2. RISTIĆ, Strahinja | BOR |
| 3. MILOVANOVIĆ, Ivan | SJU |
| 3. ĐORĐEVIĆ, Lazar | 13U |
| 5. SARIĆ, Andrej | FDŽ |
| 5. JOVANOVIĆ, Lazar | GVB |
| 7. | |
| 7. | |

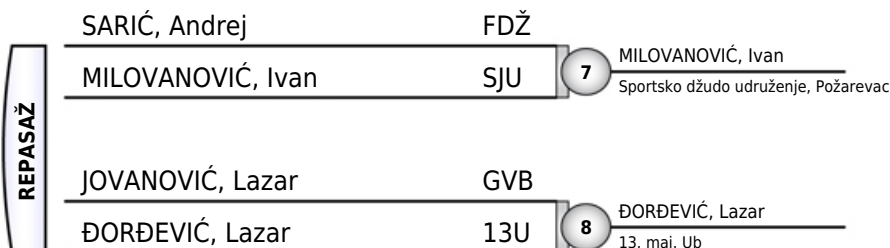



SREBRNO JEZERO 2026 I DAN

Veliko Gradište, 13.06.2026.

Kadeti

-66KG

13 takmičara

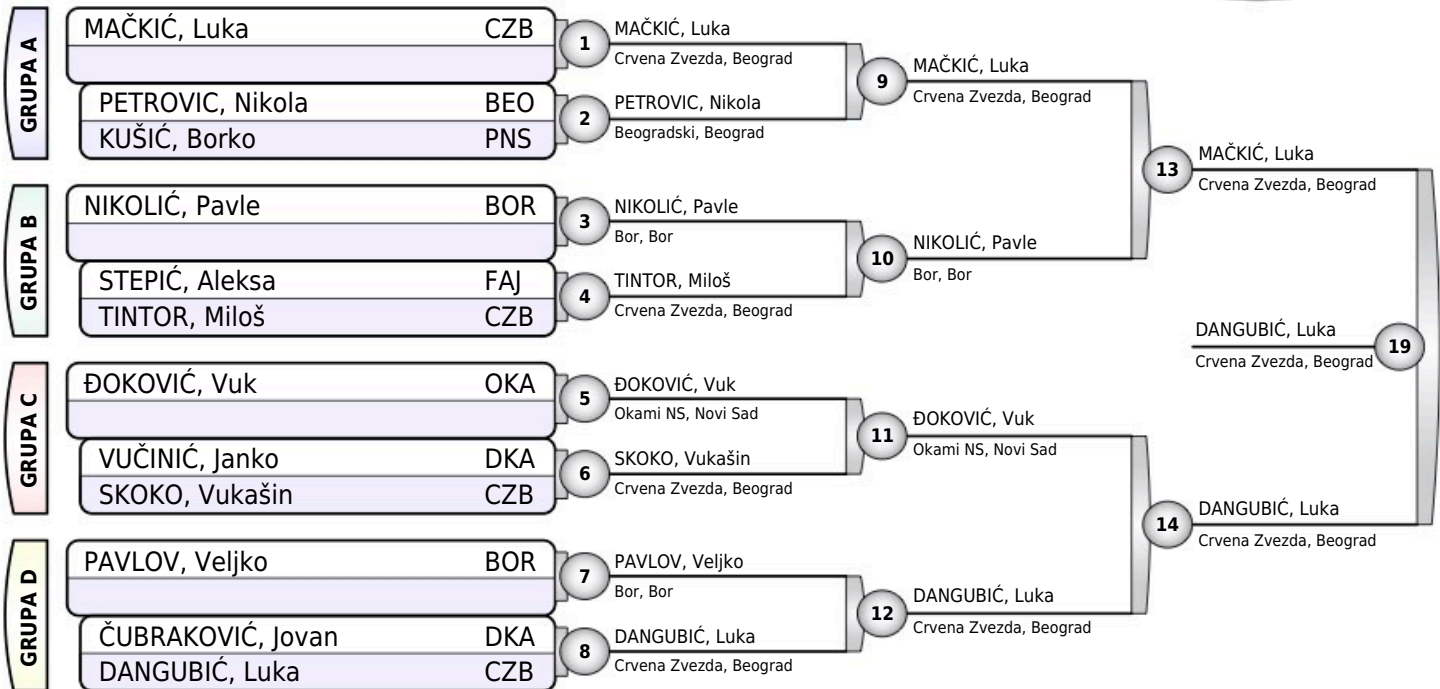

Rezultati

1. DANGUBIĆ, Luka (CZB)
2. MAČKIĆ, Luka (CZB)
3. NIKOLIĆ, Pavle (BOR)
3. PAVLOV, Veljko (BOR)
5. PETROVIC, Nikola (BEO)
5. ĐOKOVIĆ, Vuk (OKA)
7. ČUBRAKOVIĆ, Jovan (DKA)
- 7.

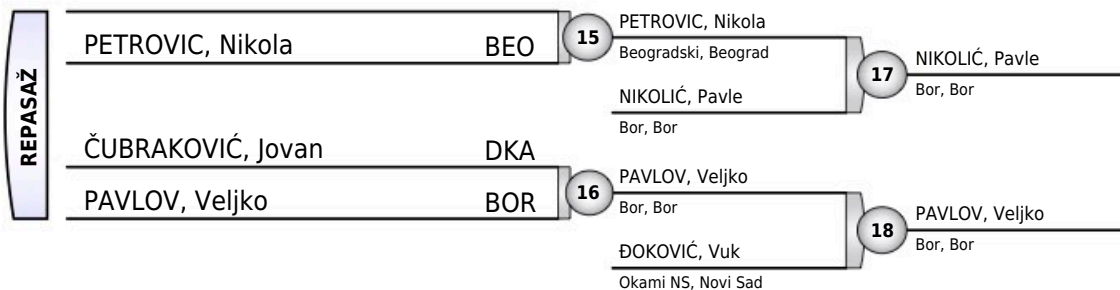



SREBRNO JEZERO 2026 I DAN

Veliko Gradište, 13.06.2026.

Kadeti

-73KG

9 takmičara

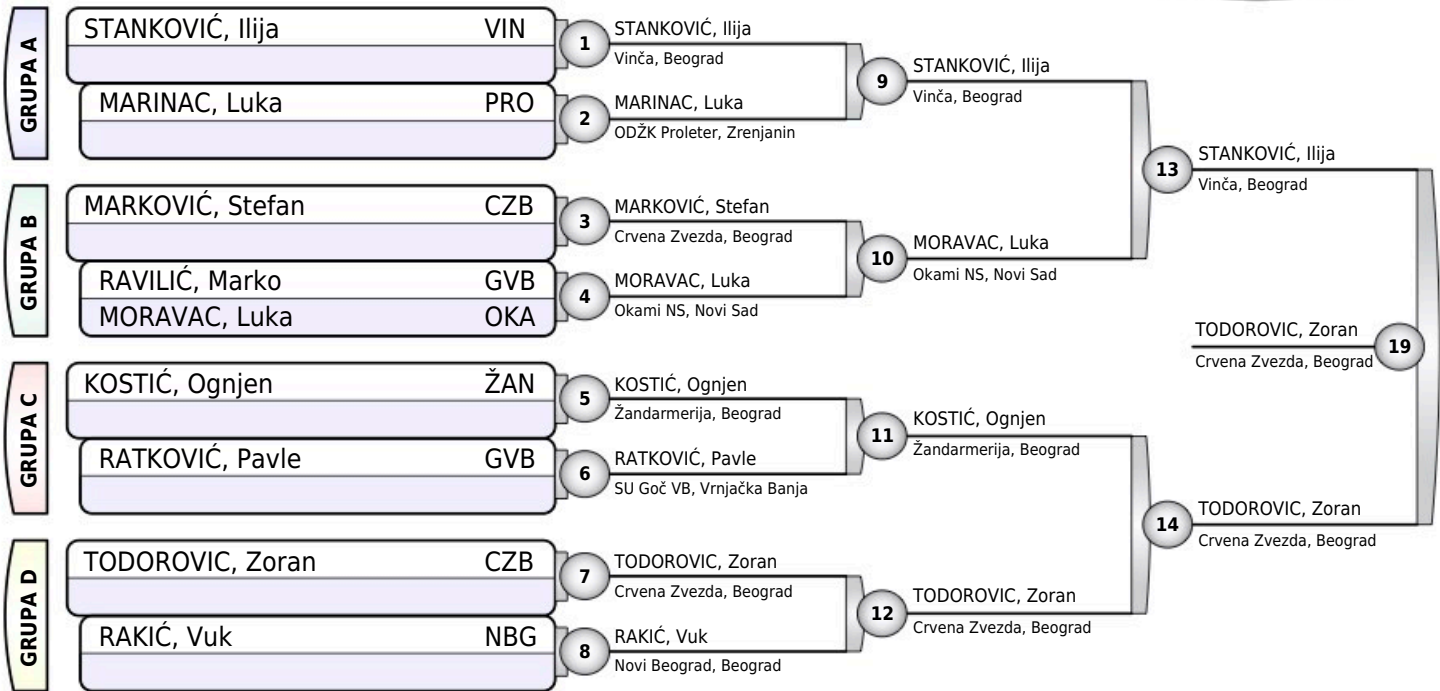

Rezultati

1. TODOROVIC, Zoran CZB
2. STANKOVIĆ, Ilija VIN
3. MORAVAC, Luka OKA
3. KOSTIĆ, Ognjen ŽAN
5. MARINAC, Luka PRO
5. RAKIĆ, Vuk NBG
- 7.
- 7.

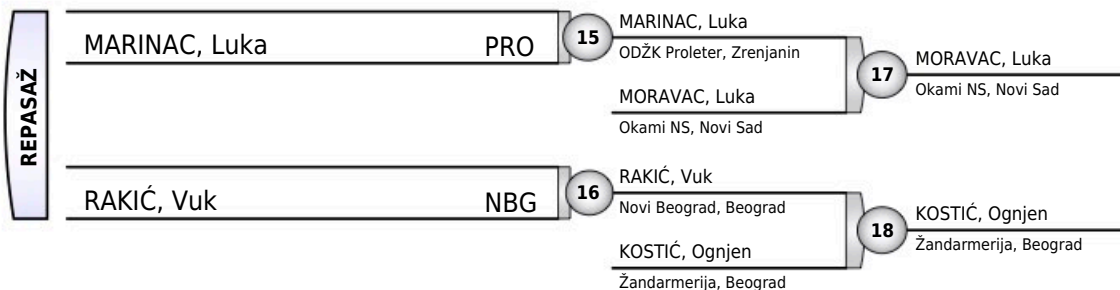



SREBRNO JEZERO 2026 I DAN

Veliko Gradište, 13.06.2026.

Kadeti

-81KG

9 takmičara

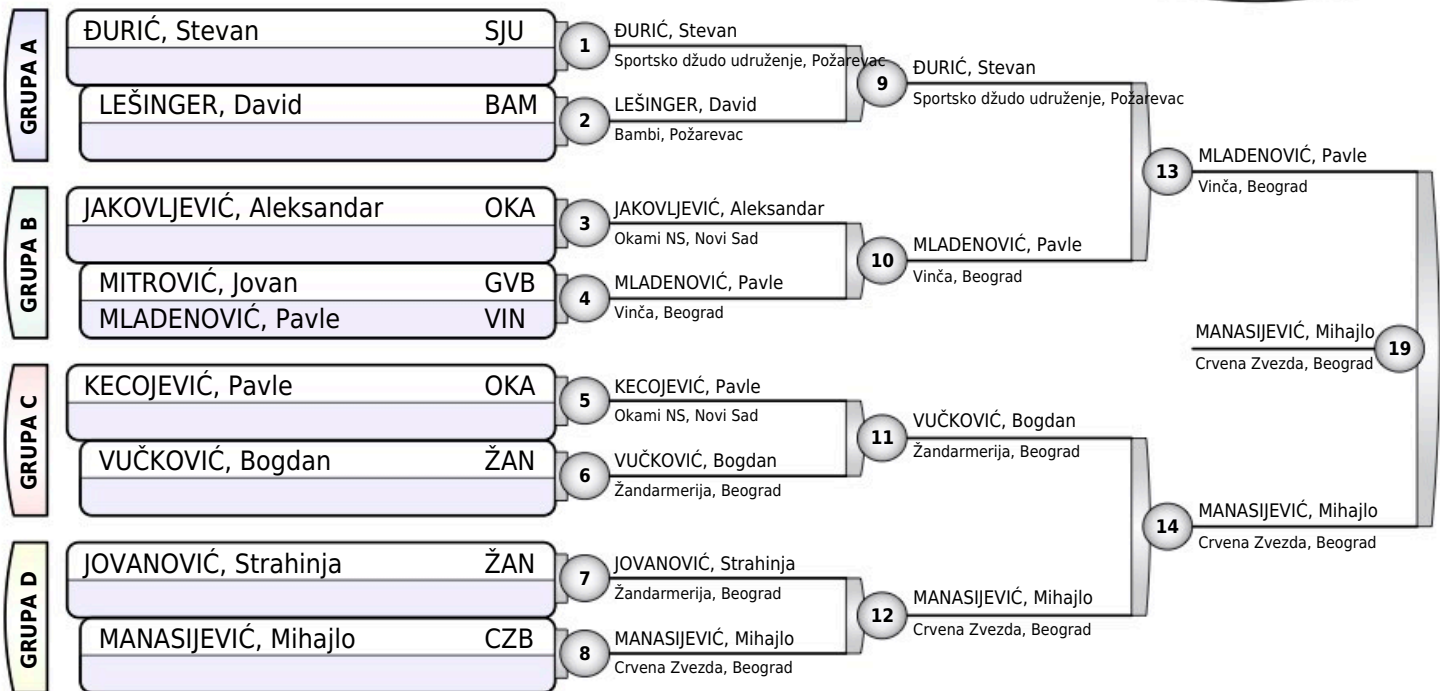

Rezultati

1. MANASIJEVIĆ, Mihajlo CZB
2. MLADENOVIĆ, Pavle VIN
3. ĐURIĆ, Stevan SJU
3. JOVANOVIĆ, Strahinja ŽAN
5. JAKOVLJEVIĆ, Aleksandar OKA
5. VUČKOVIĆ, Bogdan ŽAN
7. MITROVIĆ, Jovan GVB
- 7.

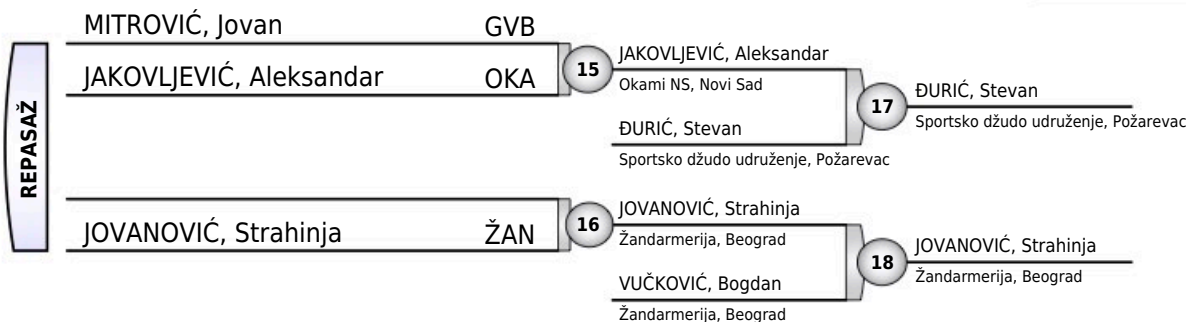



SREBRNO JEZERO 2026 I DAN

Veliko Gradište, 13.06.2026.

Kadeti

-90KG

3 takmičara

| Takmičar i klub | 1 | 2 | 3 | Pobeda | Bodova | Mesto |
|--|-----|---|---|--------|--------|-------|
| 1 ČOLAKOVIĆ, David Džudoka, Beograd | | 0 | 0 | 0 | 0 | 3 |
| 2 MILENKOVIĆ, Ognjen 13. maj, Ub | 100 | | 1 | 2 | 101 | 1 |
| 3 VUČIĆEVIĆ, Mihajlo Crvena Zvezda, Beograd | 100 | 0 | | 1 | 100 | 2 |

| | | | |
|--------------------|-----|---|------------------------|
| ČOLAKOVIĆ, David | DKA | 1 | MILENKOVIĆ, Ognjen |
| MILENKOVIĆ, Ognjen | 13U | | 13. maj, Ub |
| ČOLAKOVIĆ, David | DKA | 2 | VUČIĆEVIĆ, Mihajlo |
| VUČIĆEVIĆ, Mihajlo | CZB | | Crvena Zvezda, Beograd |
| MILENKOVIĆ, Ognjen | 13U | 3 | MILENKOVIĆ, Ognjen |
| VUČIĆEVIĆ, Mihajlo | CZB | | 13. maj, Ub |

Rezultati

1. MILENKOVIĆ, Ognjen 13U
2. VUČIĆEVIĆ, Mihajlo CZB
3. ČOLAKOVIĆ, David DKA



SREBRNO JEZERO 2026 I DAN

Veliko Gradište, 13.06.2026.

Kadeti

+90KG

4 takmičara

| Takmičar i klub | 1 | 2 | 3 | 4 | Pobeda | Bodova | Mesto |
|--|---|----|-----|-----|--------|--------|-------|
| 1 DRAGAŠ, Komnen Crvena Zvezda, Beograd | | 10 | 100 | 100 | 3 | 210 | 1 |
| 2 MARIJAN, Ognjen Žandarmerija, Beograd | 0 | | 100 | 100 | 2 | 200 | 2 |
| 3 POPOVIĆ, Lazar 13. maj, Ub | 0 | 0 | | 0 | 0 | 0 | 3 |
| 4 DRAGAŠ, Konstantin Crvena Zvezda, Beograd | 0 | 0 | 1 | | 1 | 1 | 3 |

| | | | |
|--------------------|-----|---|------------------------|
| DRAGAŠ, Komnen | CZB | 1 | DRAGAŠ, Komnen |
| MARIJAN, Ognjen | ŽAN | | Crvena Zvezda, Beograd |
| POPOVIĆ, Lazar | 13U | 2 | DRAGAŠ, Konstantin |
| DRAGAŠ, Konstantin | CZB | | Crvena Zvezda, Beograd |
| DRAGAŠ, Komnen | CZB | 3 | DRAGAŠ, Komnen |
| POPOVIĆ, Lazar | 13U | | Crvena Zvezda, Beograd |
| MARIJAN, Ognjen | ŽAN | 4 | MARIJAN, Ognjen |
| DRAGAŠ, Konstantin | CZB | | Žandarmerija, Beograd |
| DRAGAŠ, Komnen | CZB | 5 | DRAGAŠ, Komnen |
| DRAGAŠ, Konstantin | CZB | | Crvena Zvezda, Beograd |
| MARIJAN, Ognjen | ŽAN | 6 | MARIJAN, Ognjen |
| POPOVIĆ, Lazar | 13U | | Žandarmerija, Beograd |

Rezultati

1. DRAGAŠ, Komnen CZB
2. MARIJAN, Ognjen ŽAN
3. DRAGAŠ, Konstantin CZB
3. POPOVIĆ, Lazar 13U



SREBRNO JEZERO 2026 I DAN

Veliko Gradište, 13.06.2026.

Kadetkinje

-44KG

2 takmičarke

NASKOVIĆ, Nina

VOŽ

1

NASKOVIĆ, Nina

Voždovac, Beograd

Rezultati

1. NASKOVIĆ, Nina

VOŽ



SREBRNO JEZERO 2026 I DAN

Veliko Gradište, 13.06.2026.

Kadetkinje

-48KG

4 takmičarke

| Takmičar i klub | 1 | 2 | 3 | 4 | Pobeda | Bodova | Mesto |
|---|-----|---|-----|-----|--------|--------|-------|
| 1 FILIPOVIĆ, Mia Hajime, Obrenovac | | 0 | 100 | 100 | 2 | 200 | 2 |
| 2 GAJIĆ, Sara Crvena Zvezda, Beograd | 100 | | 100 | 10 | 3 | 210 | 1 |
| 3 NIKOLIĆ, Dunja 13. maj, Ub | 0 | 0 | | 0 | 0 | 0 | 3 |
| 4 NASKOVIĆ, Nina Voždovac, Beograd | 0 | 0 | 100 | | 1 | 100 | 3 |

| | | | |
|----------------|-----|---|------------------------|
| FILIPOVIĆ, Mia | HAJ | 1 | GAJIĆ, Sara |
| GAJIĆ, Sara | CZB | | Crvena Zvezda, Beograd |
| NIKOLIĆ, Dunja | 13U | 2 | NASKOVIĆ, Nina |
| NASKOVIĆ, Nina | VOŽ | | Voždovac, Beograd |
| FILIPOVIĆ, Mia | HAJ | 3 | FILIPOVIĆ, Mia |
| NIKOLIĆ, Dunja | 13U | | Hajime, Obrenovac |
| GAJIĆ, Sara | CZB | 4 | GAJIĆ, Sara |
| NASKOVIĆ, Nina | VOŽ | | Crvena Zvezda, Beograd |
| FILIPOVIĆ, Mia | HAJ | 5 | FILIPOVIĆ, Mia |
| NASKOVIĆ, Nina | VOŽ | | Hajime, Obrenovac |
| GAJIĆ, Sara | CZB | 6 | GAJIĆ, Sara |
| NIKOLIĆ, Dunja | 13U | | Crvena Zvezda, Beograd |

Rezultati

- GAJIĆ, Sara CZB
- FILIPOVIĆ, Mia HAJ
- NASKOVIĆ, Nina VOŽ
- NIKOLIĆ, Dunja 13U



SREBRNO JEZERO 2026 I DAN

Veliko Gradište, 13.06.2026.

Kadetkinje

-52KG

3 takmičarke

| Takmičar i klub | 1 | 2 | 3 | Pobeda | Bodova | Mesto |
|--|-----|---|-----|--------|--------|-------|
| 1 ERDELJAN, Lena Dinamo, Pančevo | | 0 | 100 | 1 | 100 | 2 |
| 2 PAVLOVIĆ, Anđelina Crvena Zvezda, Beograd | 100 | | 100 | 2 | 200 | 1 |
| 3 STANKOVIĆ, Lena SU Fudži, Beograd | 0 | 0 | | 0 | 0 | 3 |

| | | | |
|--------------------|-----|---|------------------------|
| ERDELJAN, Lena | DIN | 1 | PAVLOVIĆ, Anđelina |
| PAVLOVIĆ, Anđelina | CZB | | Crvena Zvezda, Beograd |
| ERDELJAN, Lena | DIN | 2 | ERDELJAN, Lena |
| STANKOVIĆ, Lena | FDŽ | | Dinamo, Pančevo |
| PAVLOVIĆ, Anđelina | CZB | 3 | PAVLOVIĆ, Anđelina |
| STANKOVIĆ, Lena | FDŽ | | Crvena Zvezda, Beograd |

Rezultati

1. PAVLOVIĆ, Anđelina CZB
2. ERDELJAN, Lena DIN
3. STANKOVIĆ, Lena FDŽ



SREBRNO JEZERO 2026 I DAN

Veliko Gradište, 13.06.2026.

Kadetkinje

-57KG

5 takmičarki

| Takmičar i klub | 1 | 2 | 3 | 4 | 5 | Pobeda | Bodova | Mesto |
|--|-----|-----|-----|-----|-----|--------|--------|-------|
| 1 ILIOSKA, Teodora SEISHIN, Prilep | /// | 0 | 0 | 0 | 0 | 0 | 0 | 5 |
| 2 ŽIVKOVIĆ, Tamara Crvena Zvezda, Beograd | 100 | /// | 100 | 10 | 0 | 3 | 210 | 2 |
| 3 DRAGIĆEVIĆ, Nevena 13. maj, Ub | 100 | 0 | /// | 100 | 0 | 2 | 200 | 3 |
| 4 DRAŠKOVIĆ, Dunja Crvena Zvezda, Beograd | 100 | 0 | 0 | /// | 0 | 1 | 100 | 3 |
| 5 STAJČIĆ, Teodora 13. maj, Ub | 100 | 100 | 10 | 100 | /// | 4 | 310 | 1 |

| | | | |
|--------------------|-----|----|------------------------|
| ILIOSKA, Teodora | SEI | 1 | ŽIVKOVIĆ, Tamara |
| ŽIVKOVIĆ, Tamara | CZB | | Crvena Zvezda, Beograd |
| DRAGIĆEVIĆ, Nevena | 13U | 2 | DRAGIĆEVIĆ, Nevena |
| DRAŠKOVIĆ, Dunja | CZB | | 13. maj, Ub |
| ILIOSKA, Teodora | SEI | 3 | STAJČIĆ, Teodora |
| STAJČIĆ, Teodora | 13U | | 13. maj, Ub |
| ŽIVKOVIĆ, Tamara | CZB | 4 | ŽIVKOVIĆ, Tamara |
| DRAGIĆEVIĆ, Nevena | 13U | | Crvena Zvezda, Beograd |
| DRAŠKOVIĆ, Dunja | CZB | 5 | STAJČIĆ, Teodora |
| STAJČIĆ, Teodora | 13U | | 13. maj, Ub |
| ILIOSKA, Teodora | SEI | 6 | DRAGIĆEVIĆ, Nevena |
| DRAGIĆEVIĆ, Nevena | 13U | | 13. maj, Ub |
| ŽIVKOVIĆ, Tamara | CZB | 7 | ŽIVKOVIĆ, Tamara |
| DRAŠKOVIĆ, Dunja | CZB | | Crvena Zvezda, Beograd |
| DRAGIĆEVIĆ, Nevena | 13U | 8 | STAJČIĆ, Teodora |
| STAJČIĆ, Teodora | 13U | | 13. maj, Ub |
| ILIOSKA, Teodora | SEI | 9 | DRAŠKOVIĆ, Dunja |
| DRAŠKOVIĆ, Dunja | CZB | | Crvena Zvezda, Beograd |
| ŽIVKOVIĆ, Tamara | CZB | 10 | STAJČIĆ, Teodora |
| STAJČIĆ, Teodora | 13U | | 13. maj, Ub |

Rezultati

1. STAJČIĆ, Teodora 13U
2. ŽIVKOVIĆ, Tamara CZB
3. DRAGIĆEVIĆ, Nevena 13U
3. DRAŠKOVIĆ, Dunja CZB
5. ILIOSKA, Teodora SEI



SREBRNO JEZERO 2026 I DAN

Veliko Gradište, 13.06.2026.

Kadetkinje

-63KG

6 takmičarki

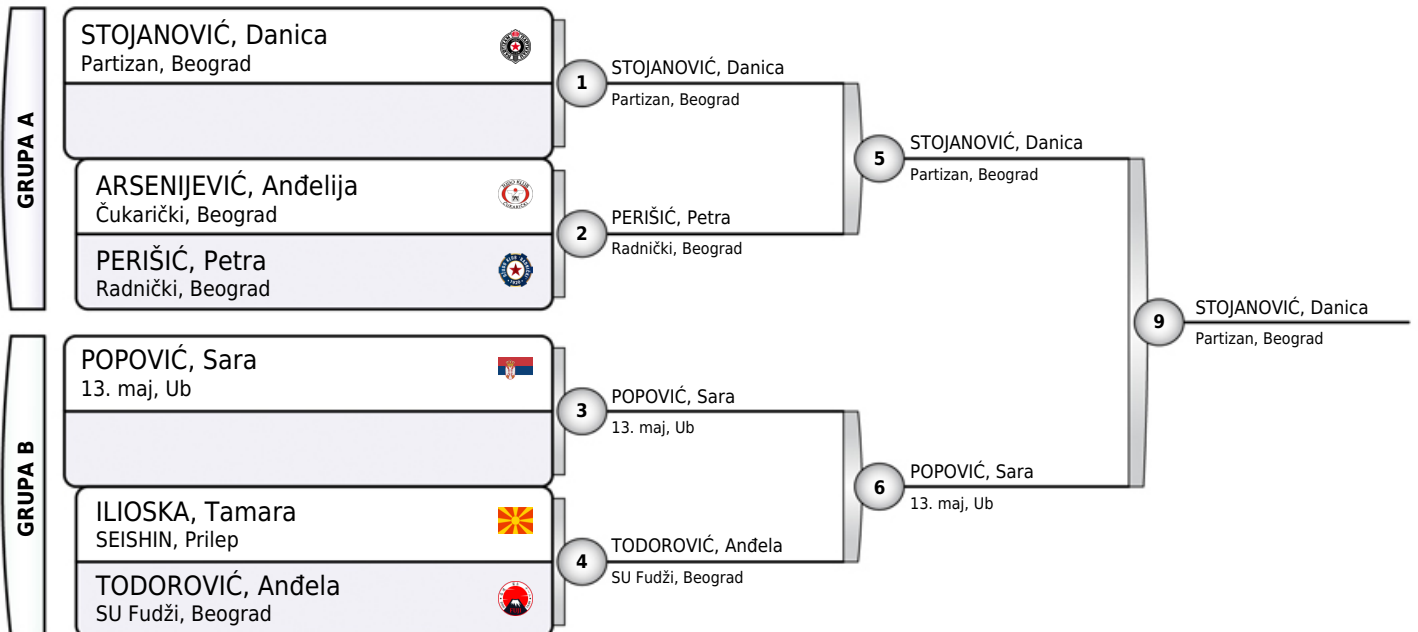

Rezultati

1. STOJANOVIĆ, Danica PBG
2. POPOVIĆ, Sara 13U
3. PERIŠIĆ, Petra RAD
3. TODOROVIĆ, Anđela FDŽ
- 5.
- 5.
- 7.
- 7.

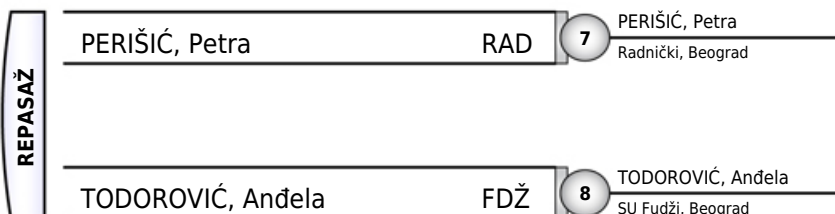



SREBRNO JEZERO 2026 I DAN

Veliko Gradište, 13.06.2026.

Kadetkinje

-70KG

3 takmičarke

| Takmičar i klub | 1 | 2 | 3 | Pobeda | Bodova | Mesto |
|---|-----|---|-----|--------|--------|-------|
| 1 JUKIĆ, Lana Okami NS, Novi Sad | | 0 | 0 | 0 | 0 | 3 |
| 2 OSTOJIĆ, Petra AS, Beograd | 100 | | 100 | 2 | 200 | 1 |
| 3 BANĐUR, Nikolina SU Fudži, Beograd | 100 | 0 | | 1 | 100 | 2 |

| | | | |
|------------------|-----|---|-------------------|
| JUKIĆ, Lana | OKA | 1 | OSTOJIĆ, Petra |
| OSTOJIĆ, Petra | ASR | | AS, Beograd |
| JUKIĆ, Lana | OKA | 2 | BANĐUR, Nikolina |
| BANĐUR, Nikolina | FDŽ | | SU Fudži, Beograd |
| OSTOJIĆ, Petra | ASR | 3 | OSTOJIĆ, Petra |
| BANĐUR, Nikolina | FDŽ | | AS, Beograd |

Rezultati

1. OSTOJIĆ, Petra ASR
2. BANĐUR, Nikolina FDŽ
3. JUKIĆ, Lana OKA



SREBRNO JEZERO 2026 I DAN

Veliko Gradište, 13.06.2026.

Kadetkinje

+70KG

1 takmičarka

PANTELIĆ, Iva

FAJ

1

PANTELIĆ, Iva

Fajter, Obrenovac

Rezultati

1. PANTELIĆ, Iva

FAJ