

21. Međunarodni džudo turnir TURIJA 2019

Turija, 03.03.2019 - Stariji poletarci



-22kg

6 takmičara

| BORBE | TAKMIČAR | BODOVA | BODOVA | TAKMIČAR | VREME |
|-------|--------------------------------------|--------|--------|--|-------|
| 1 - 2 | BRKLJAC, Nemanja Džuns, Novi Sad | 0 | 100 | MARTINOVIĆ, Manuel Turija, Turija | 0:23 |
| 1 - 3 | BRKLJAC, Nemanja Džuns, Novi Sad | 0 | 100 | MARIS, Radu Judo Phoenix, Timisoara | 0:25 |
| 2 - 3 | MARTINOVIĆ, Manuel Turija, Turija | 0 | 100 | MARIS, Radu Judo Phoenix, Timisoara | 0:14 |

| | | | | | |
|------|--------------------|-----|---|-------------------------|---|
| [A1] | MARIS, Radu | PHO | 7 | MARIS, Radu | 9 |
| [B2] | BILTIU, Marc | PHO | | Judo Phoenix, Timisoara | |
| [B1] | HERŠČAK, Ognjen | PNS | 8 | HERŠČAK, Ognjen | 9 |
| [A2] | MARTINOVIĆ, Manuel | TUR | | Partizan, Novi Sad | |

| BORBE | TAKMIČAR | BODOVA | BODOVA | TAKMIČAR | VREME |
|-------|---------------------------------------|--------|--------|---|-------|
| 4 - 5 | HERŠČAK, Ognjen Partizan, Novi Sad | 100 | 0 | BIROVLJEV, Ognjen Vrbas, Vrbas | 0:15 |
| 4 - 6 | HERŠČAK, Ognjen Partizan, Novi Sad | 100 | 0 | BILTIU, Marc Judo Phoenix, Timisoara | 0:40 |
| 5 - 6 | BIROVLJEV, Ognjen Vrbas, Vrbas | 0 | 100 | BILTIU, Marc Judo Phoenix, Timisoara | 0:40 |

BODOVI: Ippon 100 / Wazaari 10 / Kazna 0.5

Redosled borbi: 1 - 2 / 4 - 5 / 1 - 3 / 4 - 6 / 2 - 3 / 5 - 6

REZULTAT

| | | |
|----|-----------------|-----|
| 1. | MARIS, Radu | PHO |
| 2. | HERŠČAK, Ognjen | PNS |
| 3. | HERŠČAK, Ognjen | PNS |
| 3. | HERŠČAK, Ognjen | PNS |
| 5. | HERŠČAK, Ognjen | PNS |
| 5. | HERŠČAK, Ognjen | PNS |

21. Međunarodni džudo turnir TURIJA 2019

Turija, 03.03.2019 - Stariji poletarci



-25kg

12 takmičara

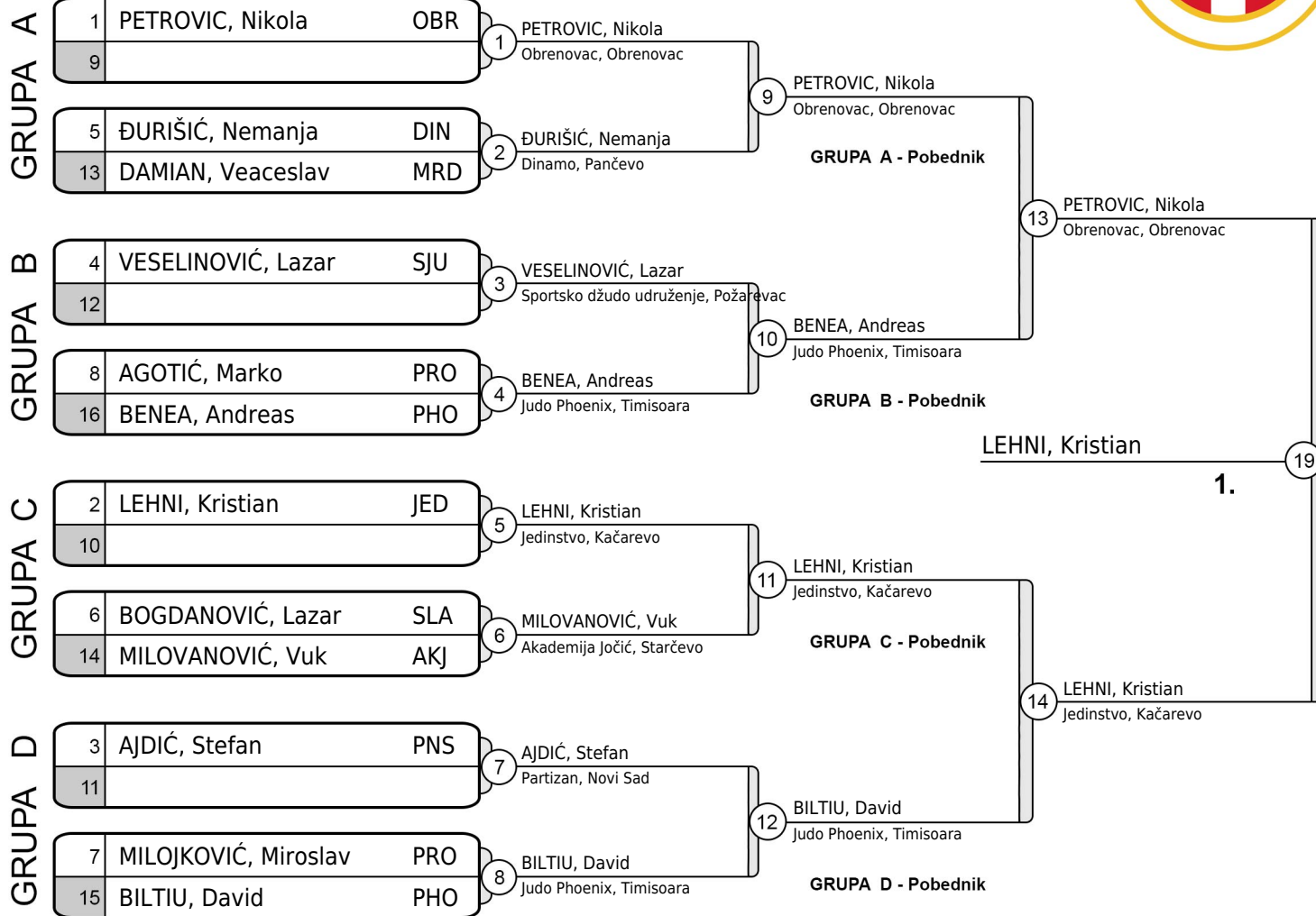

REZULTAT

| | | |
|----|------------------|-----|
| 1. | LEHNI, Kristian | JED |
| 2. | PETROVIC, Nikola | OBR |
| 3. | ĐURIŠIĆ, Nemanja | DIN |
| 3. | MILOVANOVIĆ, Vuk | AKJ |
| 5. | BENEA, Andreas | PHO |
| 5. | BILTIU, David | PHO |
| 7. | | |
| 7. | | |

REPASAŽ

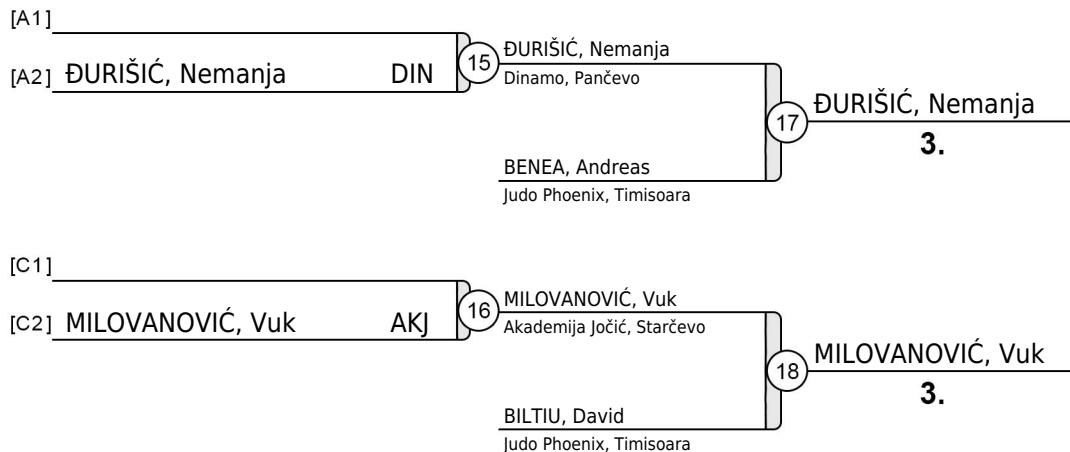

21. Međunarodni džudo turnir TURIJA 2019

Turija, 03.03.2019 - Stariji poletarci



-28kg

17 takmičara

GRUPA A

| | | |
|----|--------------------|-----|
| 1 | DOLINGA, Nikola | DIN |
| 17 | | |
| 9 | DAMJANOVIĆ, Aleksa | SRS |
| 25 | | |
| 5 | JOVANOVIĆ, Luka | OBR |
| 21 | | |
| 13 | PAVLOVIĆ, Aleksa | SLA |
| 29 | | |

| | | |
|----|--------------------|---------------------------|
| 1 | DOLINGA, Nikola | Dinamo, Pančevo |
| 2 | DAMJANOVIĆ, Aleksa | Srpski Soko, Mali Zvornik |
| 3 | JOVANOVIĆ, Luka | Obrenovac, Obrenovac |
| 4 | PAVLOVIĆ, Aleksa | Slavija, Novi Sad |
| 17 | DOLINGA, Nikola | Dinamo, Pančevo |
| 18 | PAVLOVIĆ, Aleksa | Slavija, Novi Sad |
| 25 | DOLINGA, Nikola | Dinamo, Pančevo |

GRUPA A - Pobjednik

GRUPA B

| | | |
|----|-----------------|-----|
| 4 | ŠAJFAR, Filip | CZB |
| 20 | | |
| 12 | RAFAL, David | PKO |
| 28 | | |
| 8 | VUKELIĆ, Đorđe | VOJ |
| 24 | | |
| 16 | MITROVIĆ, Dušan | PRO |
| 32 | | |

| | | |
|----|-----------------|-------------------------------|
| 5 | ŠAJFAR, Filip | Crvena Zvezda, Beograd |
| 6 | RAFAL, David | Partizan KOT Kanjiža, Kanjiža |
| 7 | VUKELIĆ, Đorđe | Vojvodina, Novi Sad |
| 8 | MITROVIĆ, Dušan | Proleter MD, Zrenjanin |
| 19 | ŠAJFAR, Filip | Crvena Zvezda, Beograd |
| 20 | MITROVIĆ, Dušan | Proleter MD, Zrenjanin |
| 26 | ŠAJFAR, Filip | Crvena Zvezda, Beograd |

GRUPA B - Pobjednik

GRUPA C

| | | |
|----|------------------|-----|
| 2 | ANĐELOVIĆ, Ilija | JED |
| 18 | | |
| 10 | ANDRASONI, Luca | PHO |
| 26 | | |
| 6 | VUČINIĆ, Vukašin | PBG |
| 22 | | |
| 14 | GEORGIEV, Martin | MRD |
| 30 | | |

| | | |
|----|------------------|------------------------------|
| 9 | ANĐELOVIĆ, Ilija | Jedinstvo, Kačarevo |
| 10 | ANDRASONI, Luca | Judo Phoenix, Timisoara |
| 11 | VUČINIĆ, Vukašin | Partizan, Beograd |
| 12 | GEORGIEV, Martin | MAKO RYU - DESANT, Bucharest |
| 21 | ANĐELOVIĆ, Ilija | Jedinstvo, Kačarevo |
| 22 | GEORGIEV, Martin | MAKO RYU - DESANT, Bucharest |
| 27 | ANĐELOVIĆ, Ilija | Jedinstvo, Kačarevo |

GRUPA C - Pobjednik

GRUPA D

| | | |
|----|-----------------------|-----|
| 3 | ADAMOVIĆ, Dušan | SLA |
| 19 | | |
| 11 | MANOJLOVIĆ, Strahinja | CZB |
| 27 | KALAPATI, Dominik | TSK |
| 7 | BAJUS, Daniel | PKO |
| 23 | | |
| 15 | PRAPORSKI, Nikola | PRO |
| 31 | | |

| | | |
|----|-----------------------|-------------------------------|
| 13 | ADAMOVIĆ, Dušan | Slavija, Novi Sad |
| 14 | MANOJLOVIĆ, Strahinja | Crvena Zvezda, Beograd |
| 15 | BAJUS, Daniel | Partizan KOT Kanjiža, Kanjiža |
| 16 | PRAPORSKI, Nikola | Proleter MD, Zrenjanin |
| 23 | MANOJLOVIĆ, Strahinja | Crvena Zvezda, Beograd |
| 24 | BAJUS, Daniel | Partizan KOT Kanjiža, Kanjiža |
| 28 | MANOJLOVIĆ, Strahinja | Crvena Zvezda, Beograd |

GRUPA D - Pobjednik

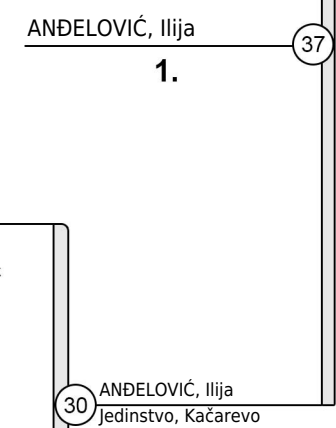

| REZULTAT | |
|----------|---------------------------|
| 1. | ANĐELOVIĆ, Ilija JED |
| 2. | DOLINGA, Nikola DIN |
| 3. | DAMJANOVIĆ, Aleksa SRS |
| 3. | GEORGIEV, Martin MRD |
| 5. | ŠAJFAR, Filip CZB |
| 5. | MANOJLOVIĆ, Strahinja CZB |
| 7. | PAVLOVIĆ, Aleksa SLA |
| 7. | ANDRASONI, Luca PHO |

REPASAŽ

| | | |
|------|--------------------|-----|
| [A1] | | |
| [A2] | DAMJANOVIĆ, Aleksa | SRS |
| 31 | DAMJANOVIĆ, Aleksa | |
| | PAVLOVIĆ, Aleksa | |
| 33 | DAMJANOVIĆ, Aleksa | |

| | | |
|----|--------------------|--|
| 35 | DAMJANOVIĆ, Aleksa | |
| | ŠAJFAR, Filip | |

3.

| | | |
|------|------------------|-----|
| [C1] | | |
| [C2] | ANDRASONI, Luca | PHO |
| 32 | ANDRASONI, Luca | |
| | GEORGIEV, Martin | |
| 34 | GEORGIEV, Martin | |

| | | |
|----|-----------------------|--|
| 36 | GEORGIEV, Martin | |
| | MANOJLOVIĆ, Strahinja | |

3.

21. Međunarodni džudo turnir TURIJA 2019

Turija, 03.03.2019 - Stariji poletarci

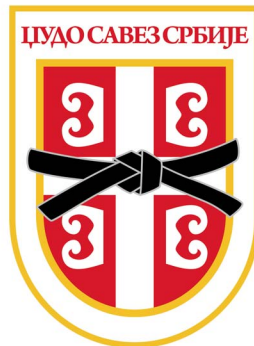

-34kg

19 takmičara

GRUPA A

| | | |
|----|---------------------|-----|
| 1 | DOBRIJEVIĆ, Mihailo | DZU |
| 17 | | |
| 9 | PINTRIJEL, David | MRD |
| 25 | | |
| 5 | RADANOV, Nikola | DIN |
| 21 | | |
| 13 | GAVRILOVIĆ, Kosta | OML |
| 29 | | |

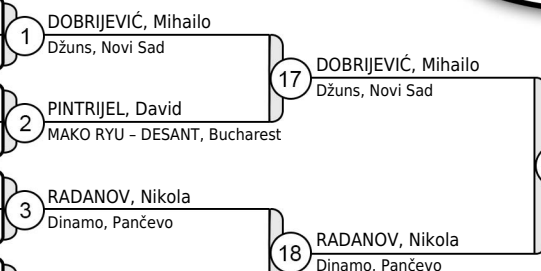

GRUPA A - Pobjednik

GRUPA B

| | | |
|----|-------------------|-----|
| 4 | JOKIĆ, Nemanja | ŽAN |
| 20 | | |
| 12 | SANDU, Ionut | MRD |
| 28 | DANGUBIĆ, Luka | CZB |
| 8 | VUČINIĆ, Vasilije | PBG |
| 24 | | |
| 16 | ANIČIĆ, Luka | OML |
| 32 | | |

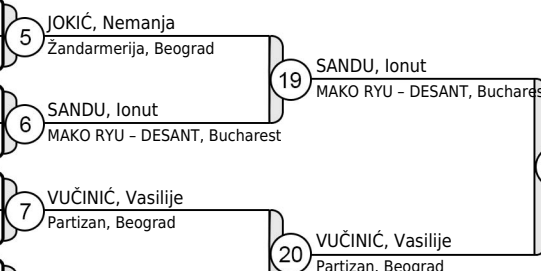

GRUPA B - Pobjednik

GRUPA C

| | | |
|----|------------------|-----|
| 2 | VELEMIROV, Dušan | OML |
| 18 | | |
| 10 | PAVKOV, Đorđe | IPO |
| 26 | KOSTIĆ, Uroš | CZB |
| 6 | MIKEC, David | CEM |
| 22 | | |
| 14 | RADEV, Boyan | MRD |
| 30 | | |

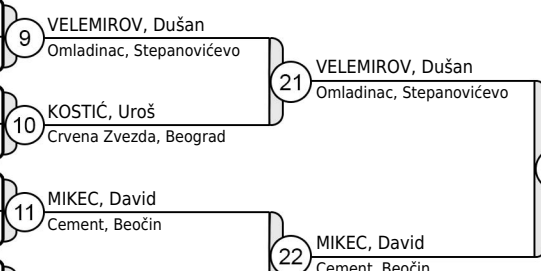

GRUPA C - Pobjednik

GRUPA D

| | | |
|----|--------------------|-----|
| 3 | PEJČIĆ, Uglješa | AKJ |
| 19 | | |
| 11 | STAMATOV, Kristian | MRD |
| 27 | DANGUBIĆ, Vuk | CZB |
| 7 | NEDIĆ, Ignjat | DZU |
| 23 | | |
| 15 | DUMITRACHE, David | MRD |
| 31 | | |

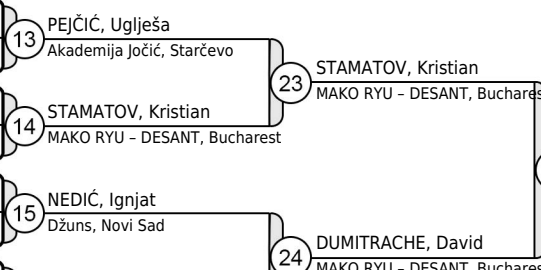

GRUPA D - Pobjednik

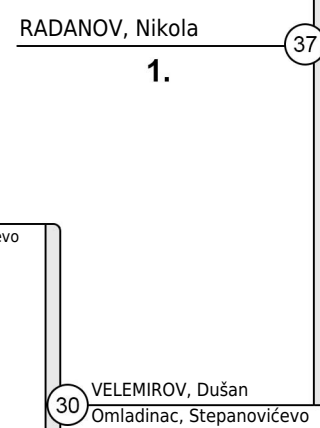

1.

| REZULTAT | |
|----------|-------------------------|
| 1. | RADANOV, Nikola DIN |
| 2. | VELEMIROV, Dušan OML |
| 3. | DOBRIJEVIĆ, Mihailo DZU |
| 3. | MIKEC, David CEM |
| 5. | SANDU, Ionut MRD |
| 5. | DUMITRACHE, David MRD |
| 7. | GAVRILOVIĆ, Kosta OML |
| 7. | KOSTIĆ, Uroš CZB |

REPASAŽ

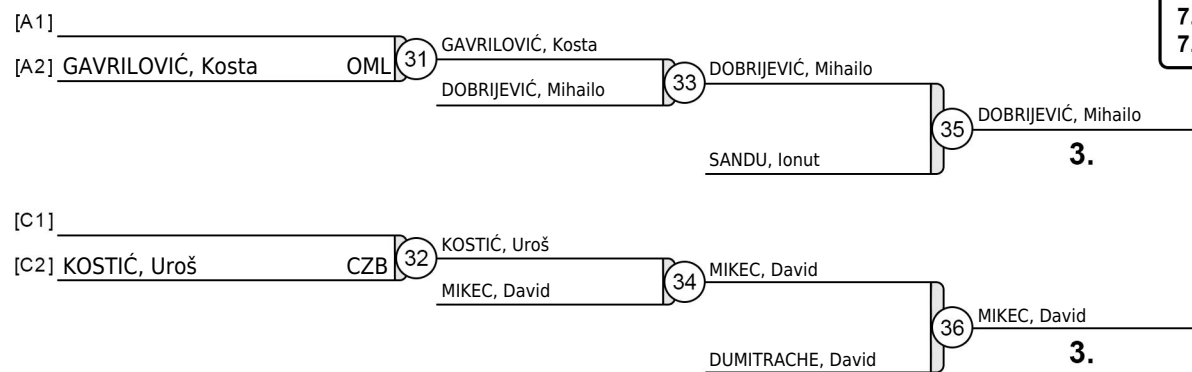

3.

3.

21. Međunarodni džudo turnir TURIJA 2019

Turija, 03.03.2019 - Stariji poletarci



-38kg

14 takmičara

GRUPA A

| | | | |
|----|-------------------|-----|--|
| 1 | ANTIĆ, Marko | TKS | 1 ANTIĆ, Marko Trudbenik KORTEGA, Beograd |
| 9 | LUKAČ, Stefan | CZB | |
| 5 | TOMAŠEVIĆ, Miljan | 021 | 2 TOMAŠEVIĆ, Miljan DIF 021, Novi Sad |
| 13 | MIKLOS, Stefan | VRB | |

GRUPA A - Pobjednik

GRUPA B

| | | | |
|----|------------------------|-----|--|
| 4 | MARINKOVIĆ, Aleksandar | CZB | 3 MARINKOVIĆ, Aleksandar Crvena Zvezda, Beograd |
| 12 | | | |
| 8 | MIOČINOVIĆ, Mateja | ŽAN | 4 MIŠKOVIĆ, Veljko Slavija, Novi Sad |
| 16 | MIŠKOVIĆ, Veljko | SLA | |

GRUPA B - Pobjednik

GRUPA C

| | | | |
|----|------------------|-----|---------------------------------------|
| 2 | MILOŠEVIĆ, Ilija | DZU | 5 MILOŠEVIĆ, Ilija Džuns, Novi Sad |
| 10 | | | |
| 6 | MILOVIĆ, Mihajlo | CEM | 6 MILOVIĆ, Mihajlo Cement, Beočin |
| 14 | RADU, Nemanja | JED | |

GRUPA C - Pobjednik

GRUPA D

| | | | |
|----|------------------|-----|---|
| 3 | OŽEGOVIĆ, Ognjen | LOK | 7 VUCKOVIĆ, Bogdan Žandarmerija, Beograd |
| 11 | VUCKOVIĆ, Bogdan | ŽAN | |
| 7 | ANIČIĆ, Uros | OML | 8 ANIČIĆ, Uros Omladinac, Stepanovićevo |
| 15 | STOJKOSKI, Filip | BUS | |

GRUPA D - Pobjednik

ANTIĆ, Marko

1.

14 ANIČIĆ, Uros
Omladinac, Stepanovićevo

13 ANTIĆ, Marko
Trudbenik KORTEGA, Beograd

9 ANTIĆ, Marko
Trudbenik KORTEGA, Beograd

10 MARINKOVIĆ, Aleksandar
Crvena Zvezda, Beograd

11 MILOŠEVIĆ, Ilija
Džuns, Novi Sad

12 ANIČIĆ, Uros
Omladinac, Stepanovićevo

REZULTAT

| | | |
|----|------------------------|-----|
| 1. | ANTIĆ, Marko | TKS |
| 2. | ANIČIĆ, Uros | OML |
| 3. | MARINKOVIĆ, Aleksandar | CZB |
| 5. | TOMAŠEVIĆ, Miljan | 021 |
| 5. | VUCKOVIĆ, Bogdan | ŽAN |
| 7. | LUKAČ, Stefan | CZB |
| 7. | STOJKOSKI, Filip | BUS |

REPASAŽ

| | | | |
|--|-------------------|-----|---|
| [A1] | LUKAČ, Stefan | CZB | 15 TOMAŠEVIĆ, Miljan DIF 021, Novi Sad |
| [A2] | TOMAŠEVIĆ, Miljan | 021 | |
| 17 MARINKOVIĆ, Aleksandar | | | |
| 3. | | | |
| MARINKOVIĆ, Aleksandar Crvena Zvezda, Beograd | | | |

| | | | |
|-------------------------------------|------------------|-----|--|
| [C1] | STOJKOSKI, Filip | BUS | 16 VUCKOVIĆ, Bogdan Žandarmerija, Beograd |
| [C2] | VUCKOVIĆ, Bogdan | ŽAN | |
| 18 MILOŠEVIĆ, Ilija | | | |
| 3. | | | |
| MILOŠEVIĆ, Ilija Džuns, Novi Sad | | | |

21. Međunarodni džudo turnir TURIJA 2019

Turija, 03.03.2019 - Stariji poletarci



-42kg

7 takmičara

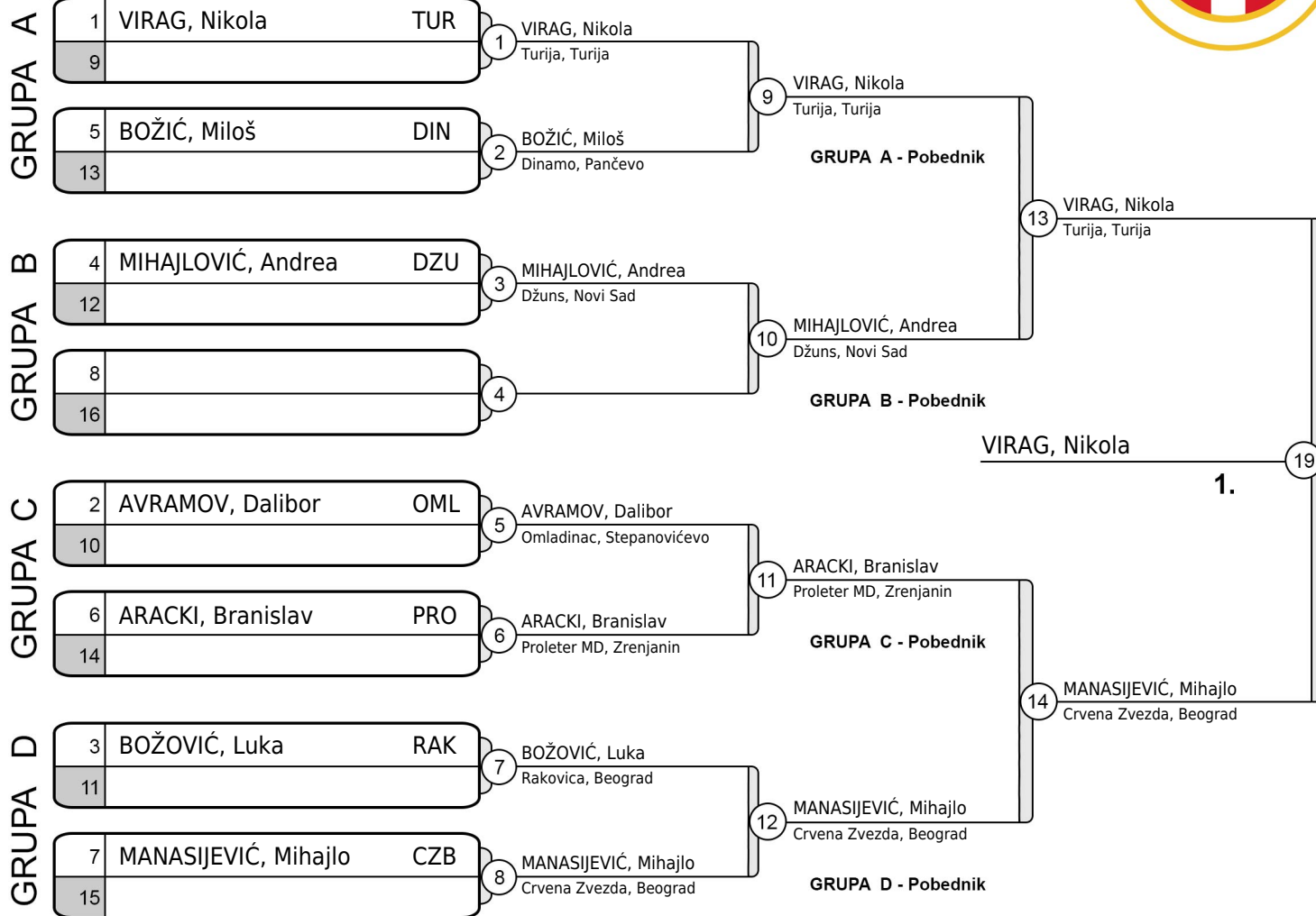

REZULTAT

- | | | |
|----|----------------------|-----|
| 1. | VIRAG, Nikola | TUR |
| 2. | MANASIJEVIĆ, Mihajlo | CZB |
| 3. | BOŽIĆ, Miloš | DIN |
| 3. | ARACKI, Branislav | PRO |
| 5. | MIHAJLOVIĆ, Andrea | DZU |
| 5. | BOŽOVIĆ, Luka | RAK |
| 7. | | |
| 7. | | |

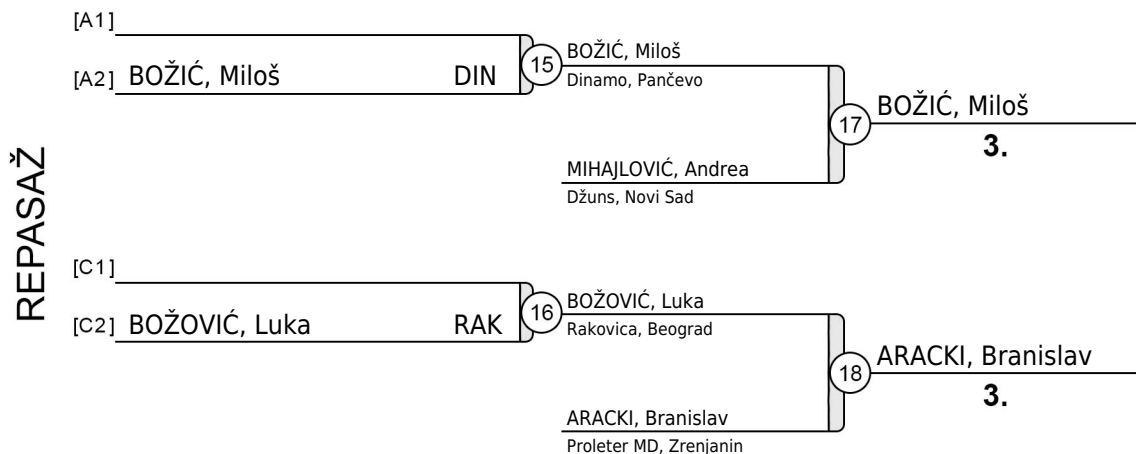

21. Međunarodni džudo turnir TURIJA 2019

Turija, 03.03.2019 - Stariji poletarci



-46kg

11 takmičara

GRUPA A

| | | |
|---|---------------|-----|
| 1 | ĐURIŠIĆ, Uroš | DIN |
| 9 | | |

| | | |
|---|---------------|-----------------|
| 1 | ĐURIŠIĆ, Uroš | Dinamo, Pančevo |
|---|---------------|-----------------|

| | | |
|---|---------------|-----------------|
| 9 | ĐURIŠIĆ, Uroš | Dinamo, Pančevo |
|---|---------------|-----------------|

| | | |
|----|----------------|-----|
| 5 | NIKOLIC, Goran | VRB |
| 13 | RAFAI, Gerge | PKO |

| | | |
|---|--------------|-------------------------------|
| 2 | RAFAI, Gerge | Partizan KOT Kanjiza, Kanjiža |
|---|--------------|-------------------------------|

GRUPA A - Pobjednik

| | | |
|----|---------------|-----------------|
| 13 | ĐURIŠIĆ, Uroš | Dinamo, Pančevo |
|----|---------------|-----------------|

GRUPA B

| | | |
|----|-----------------|-----|
| 4 | FATIĆ, Tomislav | ŽAN |
| 12 | | |

| | | |
|---|-----------------|-----------------------|
| 3 | FATIĆ, Tomislav | Žandarmerija, Beograd |
|---|-----------------|-----------------------|

| | | |
|----|-------------------|-------------------|
| 10 | BOROJEVIĆ, Veljko | Spartak, Subotica |
|----|-------------------|-------------------|

| | | |
|----|-------------------|-----|
| 8 | BOROJEVIĆ, Veljko | SPA |
| 16 | | |

| | | |
|---|-------------------|-------------------|
| 4 | BOROJEVIĆ, Veljko | Spartak, Subotica |
|---|-------------------|-------------------|

GRUPA B - Pobjednik

ĐURIŠIĆ, Uroš

1.

GRUPA C

| | | |
|----|-----------------|-----|
| 2 | MARIJAN, Ognjen | ŽAN |
| 10 | | |

| | | |
|---|-----------------|-----------------------|
| 5 | MARIJAN, Ognjen | Žandarmerija, Beograd |
|---|-----------------|-----------------------|

| | | |
|----|-----------------|-----------------------|
| 11 | MARIJAN, Ognjen | Žandarmerija, Beograd |
|----|-----------------|-----------------------|

| | | |
|----|----------------|-----|
| 6 | BUILA, Mihajlo | VRB |
| 14 | VRAČAR, Milan | TSK |

| | | |
|---|----------------|--------------|
| 6 | BUILA, Mihajlo | Vrbas, Vrbas |
|---|----------------|--------------|

GRUPA C - Pobjednik

| | | |
|----|----------------|------------------------|
| 14 | DRAGAŠ, Komnen | Crvena Zvezda, Beograd |
|----|----------------|------------------------|

GRUPA D

| | | |
|----|---------------|-----|
| 3 | ĐURIĆ, Stevan | SJU |
| 11 | | |

| | | |
|---|---------------|-------------------------------------|
| 7 | ĐURIĆ, Stevan | Sportsko džudo udruženje, Požarevac |
|---|---------------|-------------------------------------|

| | | |
|----|----------------|------------------------|
| 12 | DRAGAŠ, Komnen | Crvena Zvezda, Beograd |
|----|----------------|------------------------|

| | | |
|----|---------------------|-----|
| 7 | DRAGAŠ, Komnen | CZB |
| 15 | ABRAMOVIĆ, Tomislav | SPA |

| | | |
|---|----------------|------------------------|
| 8 | DRAGAŠ, Komnen | Crvena Zvezda, Beograd |
|---|----------------|------------------------|

GRUPA D - Pobjednik

REZULTAT

1. ĐURIŠIĆ, Uroš DIN
2. DRAGAŠ, Komnen CZB
3. BOROJEVIĆ, Veljko SPA
3. ĐURIĆ, Stevan SJU
5. RAFAI, Gerge PKO
5. MARIJAN, Ognjen ŽAN
7. ABRAMOVIĆ, Tomislav SPA

REPASAŽ

| | | |
|------|--------------|-----|
| [A1] | | |
| [A2] | RAFAI, Gerge | PKO |

| | | |
|----|--------------|-------------------------------|
| 15 | RAFAI, Gerge | Partizan KOT Kanjiza, Kanjiža |
|----|--------------|-------------------------------|

| | |
|----|-------------------|
| 17 | BOROJEVIĆ, Veljko |
|----|-------------------|

3.

BOROJEVIĆ, Veljko
Spartak, Subotica

| | | |
|------|---------------------|-----|
| [C1] | ABRAMOVIĆ, Tomislav | SPA |
|------|---------------------|-----|

| | | |
|------|---------------|-----|
| [C2] | ĐURIĆ, Stevan | SJU |
|------|---------------|-----|

| | | |
|----|---------------|-------------------------------------|
| 16 | ĐURIĆ, Stevan | Sportsko džudo udruženje, Požarevac |
|----|---------------|-------------------------------------|

| | |
|----|---------------|
| 18 | ĐURIĆ, Stevan |
|----|---------------|

3.

MARIJAN, Ognjen
Žandarmerija, Beograd

21. Međunarodni džudo turnir TURIJA 2019

Turija, 03.03.2019 - Stariji poletarci



-50kg

7 takmičara

GRUPA A

1 KOMNOS, Nikolaos TKS
9

1 KOMNOS, Nikolaos
Trudbenik KORTEGA, Beograd

5 IVKOVIĆ, David LOK
13

2 IVKOVIĆ, David
Lokomotiva, Vršac

9 KOMNOS, Nikolaos
Trudbenik KORTEGA, Beograd

GRUPA A - Pobjednik

GRUPA B

4 MARTINOVIĆ, Dušan TOR
12

3 MARTINOVIĆ, Dušan
Tori, Vrbas

8 MIĆIN, Ognjen TUR
16

4 MIĆIN, Ognjen
Turija, Turija

10 MARTINOVIĆ, Dušan
Tori, Vrbas

GRUPA B - Pobjednik

13 KOMNOS, Nikolaos
Trudbenik KORTEGA, Beograd

KOMNOS, Nikolaos

1.

GRUPA C

2 PANIĆ, Veljko OML
10

5 PANIĆ, Veljko
Omladinac, Stepanovićevo

6
14

6

11 PANIĆ, Veljko
Omladinac, Stepanovićevo

GRUPA C - Pobjednik

14 ŽIVKOVIĆ, Lazar
Vinča, Beograd

GRUPA D

3 NIKOLIĆ, Mihajlo FAJ
11

7 NIKOLIĆ, Mihajlo
Fajter, Obrenovac

7 ŽIVKOVIĆ, Lazar VIN
15

8 ŽIVKOVIĆ, Lazar
Vinča, Beograd

12 ŽIVKOVIĆ, Lazar
Vinča, Beograd

GRUPA D - Pobjednik

REZULTAT

1. KOMNOS, Nikolaos TKS
2. ŽIVKOVIĆ, Lazar VIN
3. MARTINOVIĆ, Dušan TOR
3. PANIĆ, Veljko OML
5. IVKOVIĆ, David LOK
5. NIKOLIĆ, Mihajlo FAJ
- 7.
- 7.

REPASAŽ

[A1]

[A2] IVKOVIĆ, David LOK

15 IVKOVIĆ, David
Lokomotiva, Vršac

17 MARTINOVIĆ, Dušan

3.

MARTINOVIĆ, Dušan
Tori, Vrbas

[C1]

[C2] NIKOLIĆ, Mihajlo FAJ

16 NIKOLIĆ, Mihajlo
Fajter, Obrenovac

18 PANIĆ, Veljko

3.

PANIĆ, Veljko
Omladinac, Stepanovićevo

21. Međunarodni džudo turnir TURIJA 2019

Turija, 03.03.2019 - Stariji poletarci

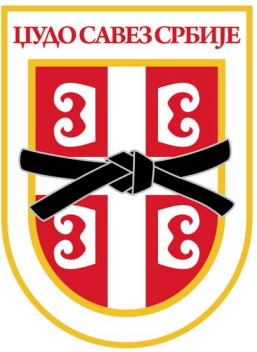

+50kg

9 takmičara

GRUPA A

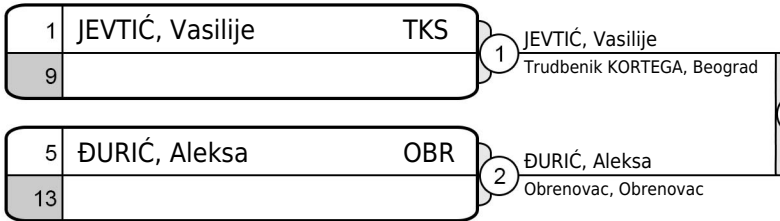

GRUPA A - Pobjednik

GRUPA B

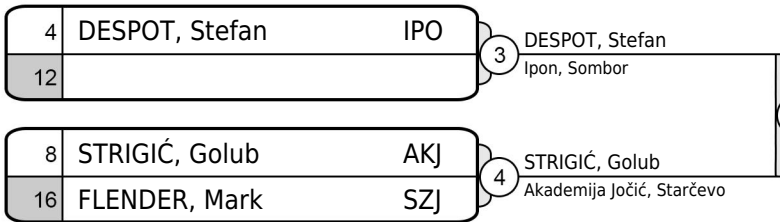

GRUPA B - Pobjednik

GRUPA C

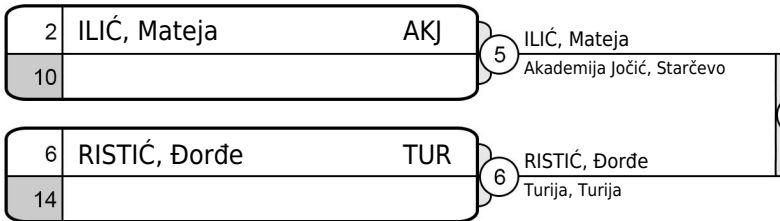

GRUPA C - Pobjednik

GRUPA D

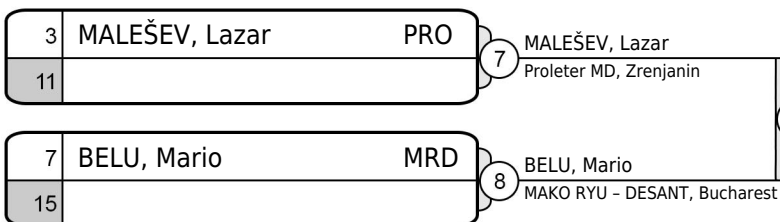

GRUPA D - Pobjednik

BELU, Mario

1.

BELU, Mario
MAKO RYU - DESANT, Bucharest

REZULTAT

- | | | |
|----|------------------|-----|
| 1. | BELU, Mario | MRD |
| 2. | JEVTIĆ, Vasilije | TKS |
| 3. | STRIGIĆ, Golub | AKJ |
| 3. | ILIĆ, Mateja | AKJ |
| 5. | ĐURIĆ, Aleksa | OBR |
| 5. | MALEŠEV, Lazar | PRO |
| 7. | | |
| 7. | | |

REPASAŽ

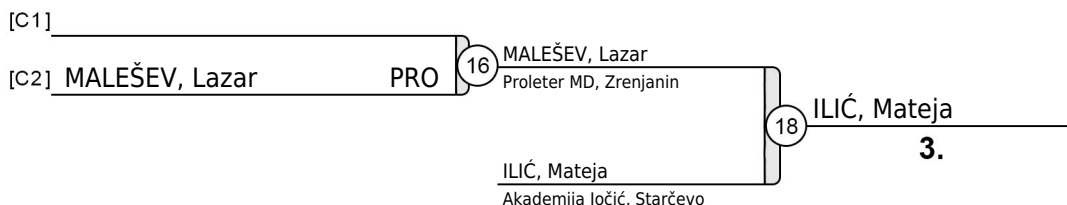
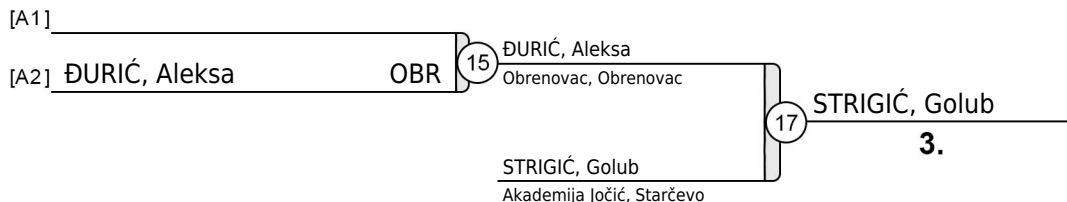

21. Međunarodni džudo turnir TURIJA 2019

Turija, 03.03.2019 - Starije poletarke



-22kg

0 takmičarki

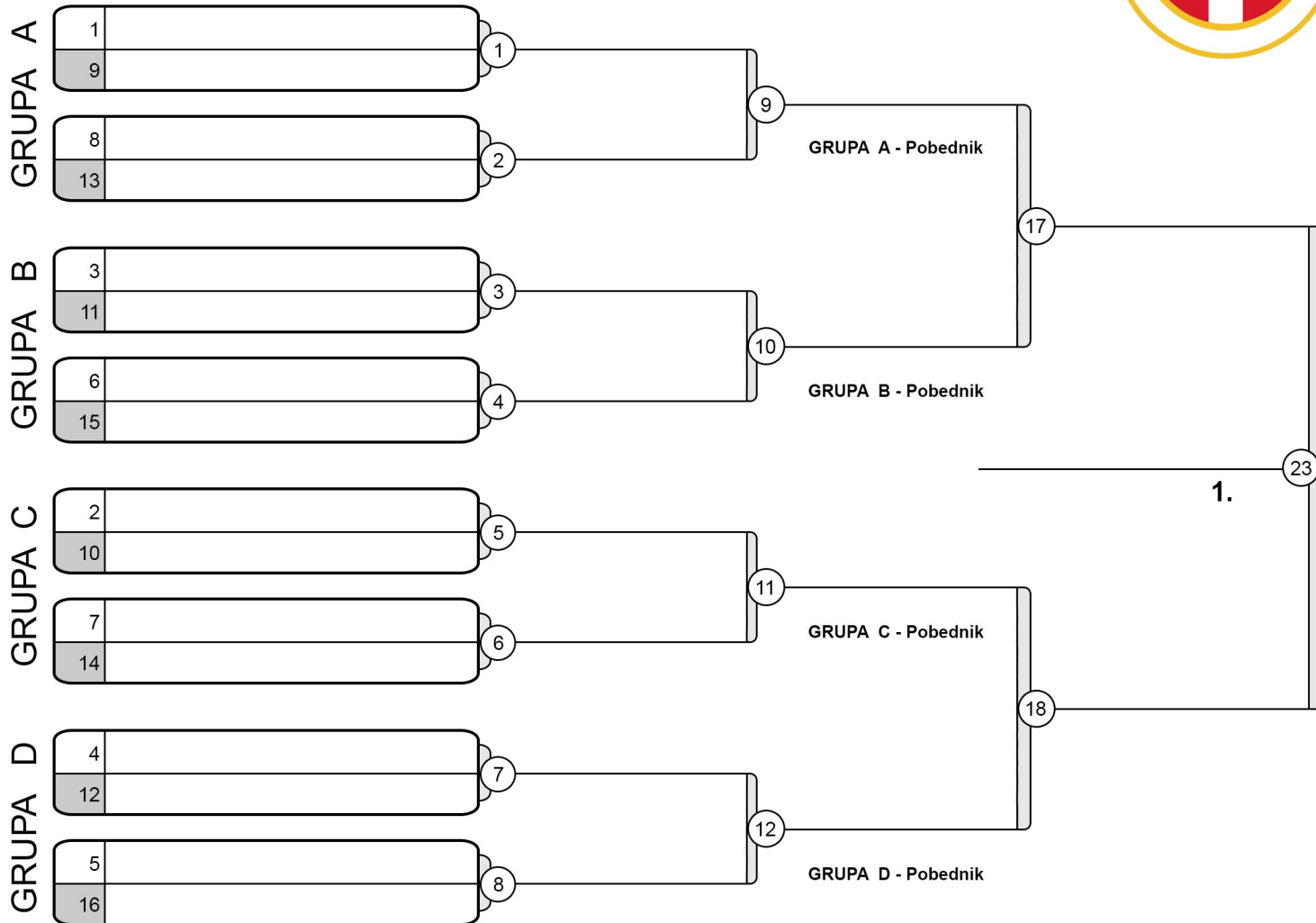

REZULTAT

- 1.
- 2.
- 3.
- 3.
- 5.
- 7.
- 7.

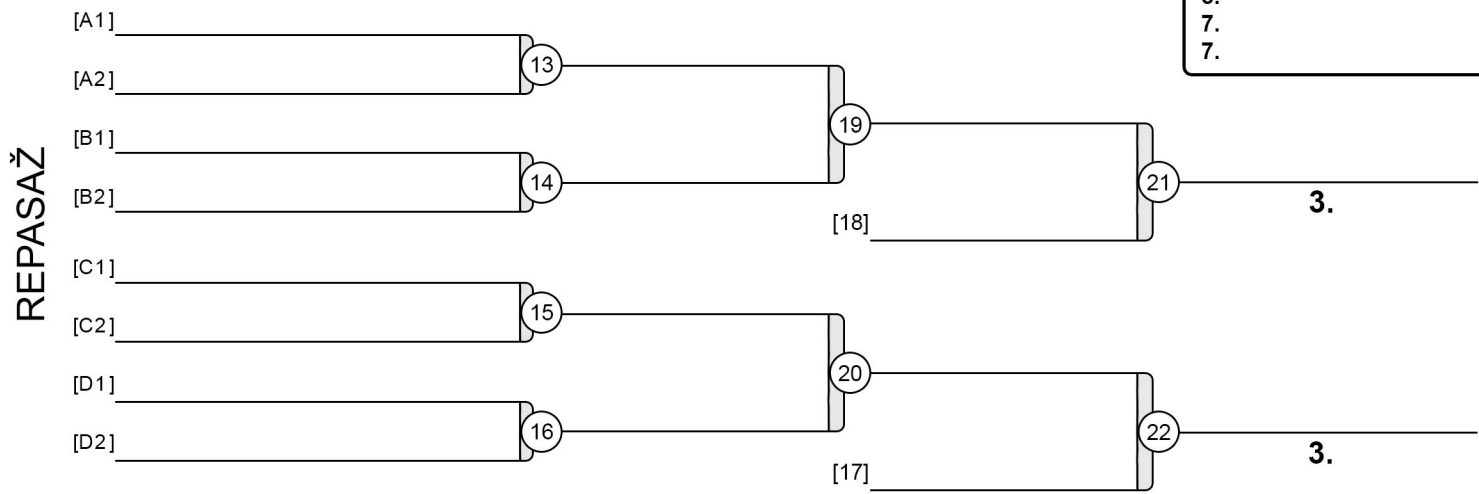

21. Međunarodni džudo turnir TURIJA 2019

Turija, 03.03.2019 - Starije poletarke



-25kg

5 takmičarki

| | TAKMIČAR | POBEDNIČKI BODOVI | | | | | POBEDA | BODOVA | MESTO |
|---|--|-------------------|---|-----|-----|-----|--------|--------|-------|
| | | 1 | 2 | 3 | 4 | 5 | | | |
| 1 | STOJANOV, Ina Žandarmerija, Beograd | | 0 | 100 | 0 | 100 | 2 | 200 | 3 |
| 2 | JOVANOVIĆ, Božana Turija, Turija | 100 | | 100 | 100 | 100 | 4 | 400 | 1 |
| 3 | MIRIĆ, Ivana Cement, Beočin | 0 | 0 | | 0 | 100 | 1 | 100 | 3 |
| 4 | ARVAI, Andrea Omladinac, Stepanovićevo | 100 | 0 | 100 | | 100 | 3 | 300 | 2 |
| 5 | MIJATOVIĆ, Katarina Srpski Soko, Mali Zvornik | 0 | 0 | 0 | 0 | | 0 | 0 | 5 |

Bodovi: Ippon 100 / Wazaari 10 / Kazna 0.5

Redosled borbi: 1 - 2, 3 - 4 / 1 - 5, 2 - 3 / 4 - 5, 1 - 3 / 2 - 4, 3 - 5 / 1 - 4, 2 - 5

| BORBE | TAKMIČAR | BODOVA | BODOVA | TAKMIČAR | VREME |
|-------|---|------------|------------|--|-------|
| 1 - 2 | STOJANOV, Ina Žandarmerija, Beograd | 0 | 100 | JOVANOVIĆ, Božana Turija, Turija | 1:23 |
| 3 - 4 | MIRIĆ, Ivana Cement, Beočin | 0 | 100 | ARVAI, Andrea Omladinac, Stepanovićevo | 0:43 |
| 1 - 5 | STOJANOV, Ina Žandarmerija, Beograd | 100 | 0 | MIJATOVIĆ, Katarina Srpski Soko, Mali Zvornik | 1:56 |
| 2 - 3 | JOVANOVIĆ, Božana Turija, Turija | 100 | 0 | MIRIĆ, Ivana Cement, Beočin | 0:50 |
| 4 - 5 | ARVAI, Andrea Omladinac, Stepanovićevo | 100 | 0 | MIJATOVIĆ, Katarina Srpski Soko, Mali Zvornik | 0:55 |
| 1 - 3 | STOJANOV, Ina Žandarmerija, Beograd | 100 | 0 | MIRIĆ, Ivana Cement, Beočin | 0:15 |
| 2 - 4 | JOVANOVIĆ, Božana Turija, Turija | 100 | 0 | ARVAI, Andrea Omladinac, Stepanovićevo | 1:27 |
| 3 - 5 | MIRIĆ, Ivana Cement, Beočin | 100 | 0 | MIJATOVIĆ, Katarina Srpski Soko, Mali Zvornik | 2:36 |
| 1 - 4 | STOJANOV, Ina Žandarmerija, Beograd | 0 | 100 | ARVAI, Andrea Omladinac, Stepanovićevo | 1:22 |
| 2 - 5 | JOVANOVIĆ, Božana Turija, Turija | 100 | 0 | MIJATOVIĆ, Katarina Srpski Soko, Mali Zvornik | 1:07 |

REZULTAT

1. JOVANOVIĆ, Božana TUR
2. ARVAI, Andrea OML
3. STOJANOV, Ina ŽAN
3. MIRIĆ, Ivana CEM
5. MIJATOVIĆ, Katarina SRS

21. Međunarodni džudo turnir TURIJA 2019

Turija, 03.03.2019 - Starije poletarke

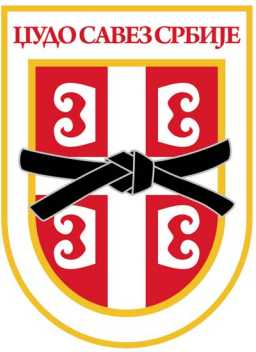

-28kg

10 takmičarki

GRUPA A

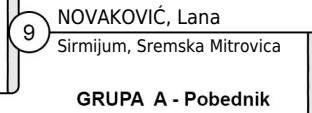
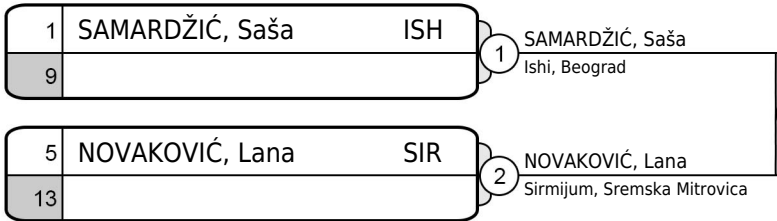

GRUPA B

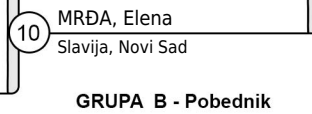
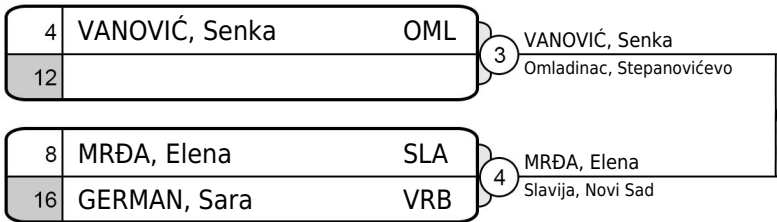

GRUPA C

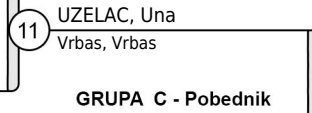
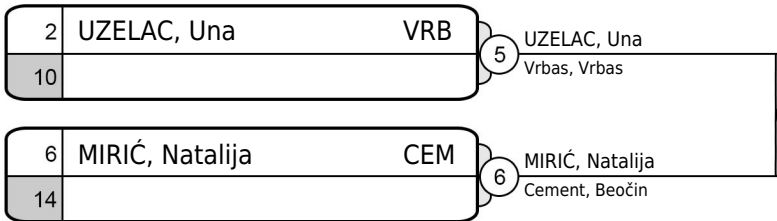

GRUPA D

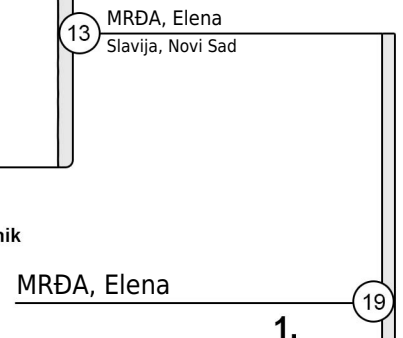
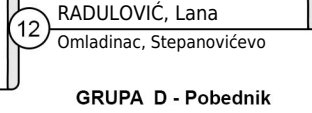
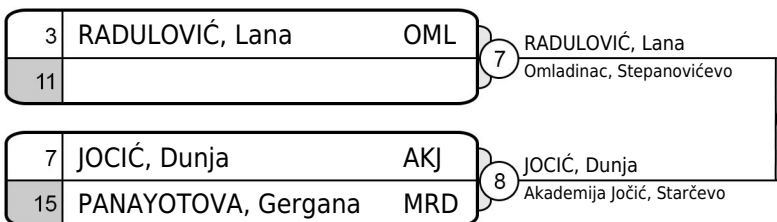

| REZULTAT | |
|----------|---------------------|
| 1. | MRĐA, Elena SLA |
| 2. | UZELAC, Una VRB |
| 3. | VANOVIĆ, Senka OML |
| 5. | RADULOVIĆ, Lana OML |
| 5. | NOVAKOVIĆ, Lana SIR |
| 7. | MIRIĆ, Natalija CEM |
| 7. | GERMAN, Sara VRB |
| 7. | |

REPASAŽ

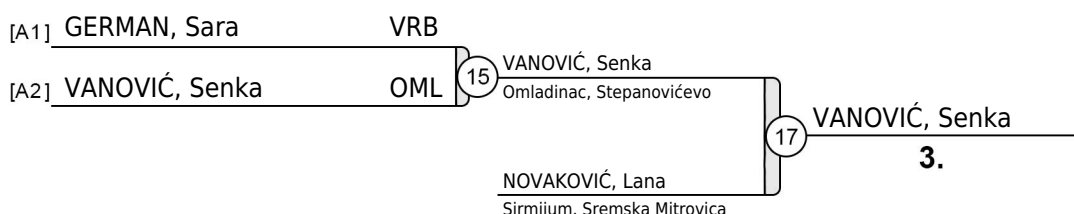

21. Međunarodni džudo turnir TURIJA 2019

Turija, 03.03.2019 - Starije poletarke



-31kg

9 takmičarki

GRUPA A

1 MIJALKOVIĆ, Lara VIN
9

1 MIJALKOVIĆ, Lara
Vinča, Beograd

5 GLIGA, Ana SFC
13

2 GLIGA, Ana
SAMURAI FLORII DE CIRES, Voiniceni

9 GLIGA, Ana
SAMURAI FLORII DE CIRES, Voiniceni

GRUPA A - Pobjednik

GRUPA B

4 SRDANOVIĆ, Nina VRB
12

3 SRDANOVIĆ, Nina
Vrbas, Vrbas

8 ŠIKOPARIJA, Dunja ISH
16

4 ŠIKOPARIJA, Dunja
Ishi, Beograd

10 SRDANOVIĆ, Nina
Vrbas, Vrbas

GRUPA B - Pobjednik

13 GLIGA, Ana
SAMURAI FLORII DE CIRES, Voiniceni

GRUPA C

2 PERIŠIĆ, Petra ISH
10

5 PERIŠIĆ, Petra
Ishi, Beograd

6 ZARIN, Maša VRB
14

6 ZARIN, Maša
Vrbas, Vrbas

11 PERIŠIĆ, Petra
Ishi, Beograd

GRUPA C - Pobjednik

GLIGA, Ana

1.

GRUPA D

3 ARBUTINA, Milica TUR
11

7 ARBUTINA, Milica
Turija, Turija

7 STEFANOVIĆ, Lenka PRO
15 PETROVIĆ, Sofija SLA

8 PETROVIĆ, Sofija
Slavija, Novi Sad

12 PETROVIĆ, Sofija
Slavija, Novi Sad

GRUPA D - Pobjednik

14 PERIŠIĆ, Petra
Ishi, Beograd

19

REZULTAT

- | | | |
|----|------------------|-----|
| 1. | GLIGA, Ana | SFC |
| 2. | PERIŠIĆ, Petra | ISH |
| 3. | SRDANOVIĆ, Nina | VRB |
| 5. | MIJALKOVIĆ, Lara | VIN |
| 5. | ZARIN, Maša | VRB |
| 7. | | |
| 7. | | |

REPASAŽ

[A1] _____
[A2] MIJALKOVIĆ, Lara VIN

15 MIJALKOVIĆ, Lara
Vinča, Beograd

17 SRDANOVIĆ, Nina

3.

SRDANOVIĆ, Nina
Vrbas, Vrbas

[C1] _____
[C2] ZARIN, Maša VRB

16 ZARIN, Maša
Vrbas, Vrbas

18 PETROVIĆ, Sofija

3.

PETROVIĆ, Sofija
Slavija, Novi Sad

21. Međunarodni džudo turnir TURIJJA 2019

Turija, 03.03.2019 - Starije poletarke



-34kg

7 takmičarki

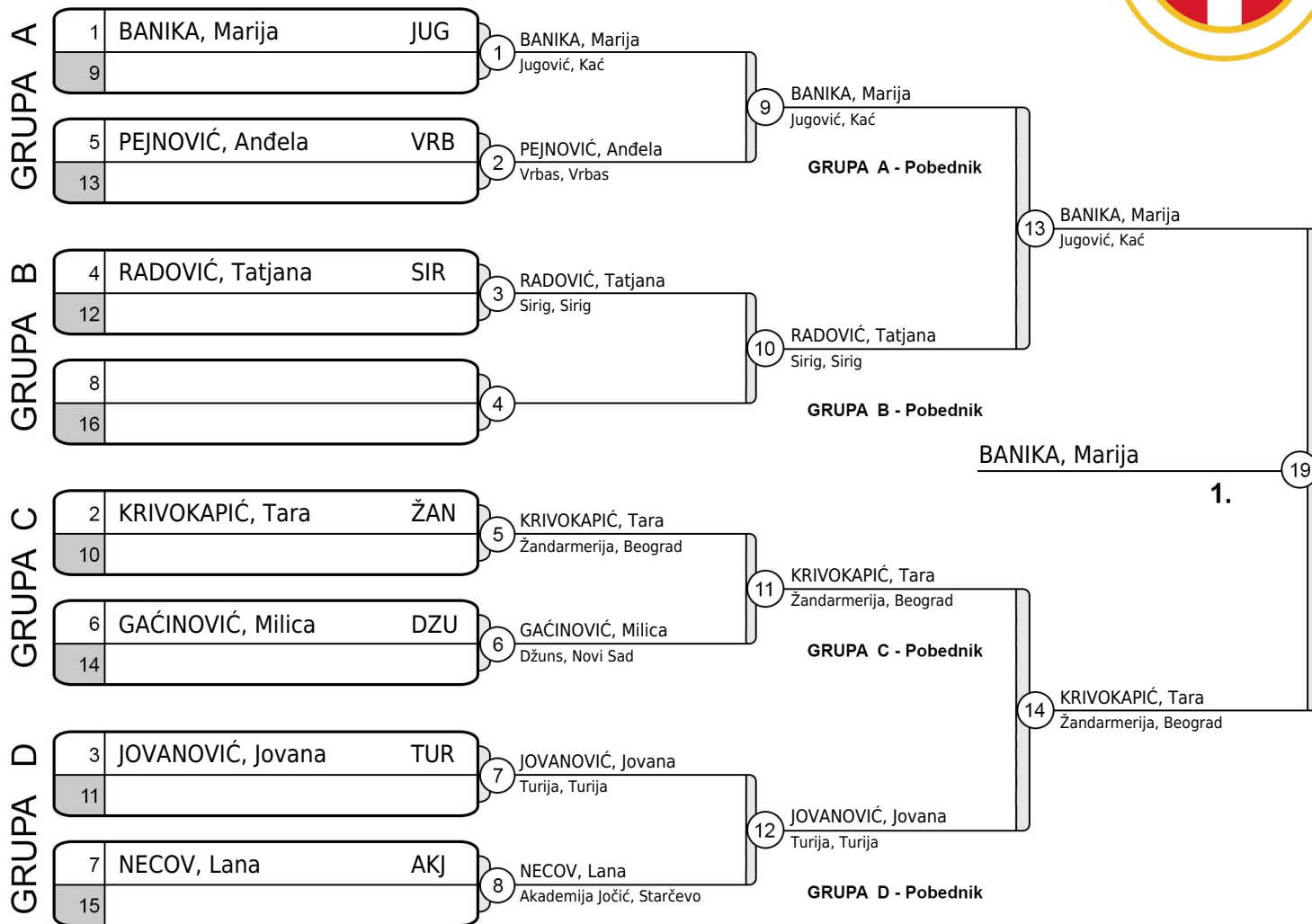

REZULTAT

1. BANIKA, Marija JUG
2. KRIVOKAPIĆ, Tara ŽAN
3. PEJNOVIĆ, Anđela VRB
3. JOVANOVIĆ, Jovana TUR
5. RADOVIĆ, Tatjana SIR
5. GAĆINOVIĆ, Milica DZU
- 7.
- 7.

REPASAŽ

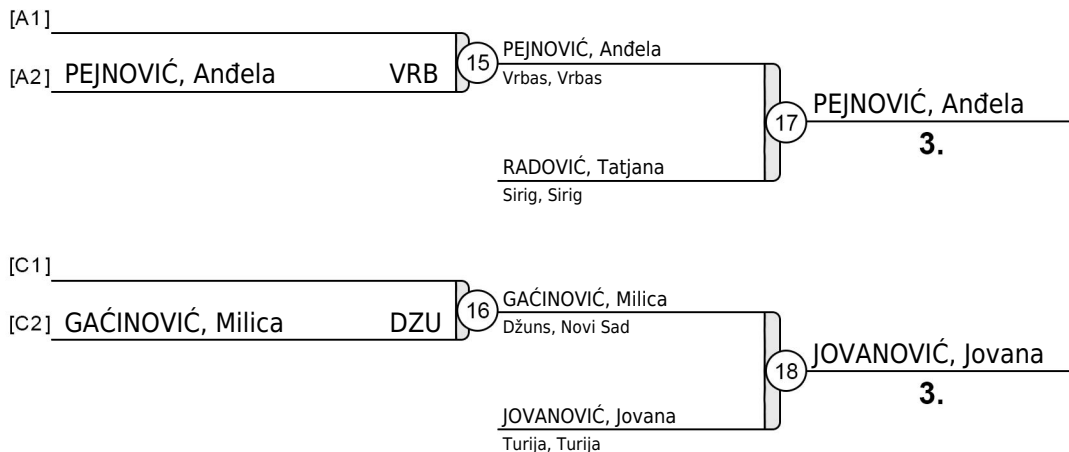

21. Međunarodni džudo turnir TURIJA 2019

Turija, 03.03.2019 - Starije poletarke



-38kg

5 takmičarki

| | TAKMIČAR | POBEDNIČKI BODOVI | | | | | POBEDA | BODOVA | MESTO |
|---|---|-------------------|-----|----|-----|-----|--------|--------|-------|
| | | 1 | 2 | 3 | 4 | 5 | | | |
| 1 | ŽIVANOVIĆ, Tijana Žandarmerija, Beograd | | 100 | 10 | 100 | 100 | 4 | 310 | 1 |
| 2 | ILIESKA, Matea Bušido, Prilep | 0 | | 0 | 0 | 100 | 1 | 100 | 3 |
| 3 | FEHER, Zara SAMURAI FLORII DE CIRES, Voiniceni | 0 | 100 | | 100 | 100 | 3 | 300 | 2 |
| 4 | MALEŠ, Mia TSK Temerin, Temerin | 0 | 100 | 0 | | 100 | 2 | 200 | 3 |
| 5 | TRAJANOVSKI, Teodora Cement, Beočin | 0 | 0 | 0 | 0 | | 0 | 0 | 5 |

Bodovi: Ippon 100 / Wazaari 10 / Kazna 0.5

Redosled borbi: 1 - 2, 3 - 4 / 1 - 5, 2 - 3 / 4 - 5, 1 - 3 / 2 - 4, 3 - 5 / 1 - 4, 2 - 5

| BORBE | TAKMIČAR | BODOVA | BODOVA | TAKMIČAR | VREME |
|-------|---|------------|------------|---|-------|
| 1 - 2 | ŽIVANOVIĆ, Tijana Žandarmerija, Beograd | 100 | 0 | ILIESKA, Matea Bušido, Prilep | 0:06 |
| 3 - 4 | FEHER, Zara SAMURAI FLORII DE CIRES, Voiniceni | 100 | 0 | MALEŠ, Mia TSK Temerin, Temerin | 1:21 |
| 1 - 5 | ŽIVANOVIĆ, Tijana Žandarmerija, Beograd | 100 | 0 | TRAJANOVSKI, Teodora Cement, Beočin | 0:07 |
| 2 - 3 | ILIESKA, Matea Bušido, Prilep | 0 | 100 | FEHER, Zara SAMURAI FLORII DE CIRES, Voiniceni | 0:20 |
| 4 - 5 | MALEŠ, Mia TSK Temerin, Temerin | 100 | 0 | TRAJANOVSKI, Teodora Cement, Beočin | 0:09 |
| 1 - 3 | ŽIVANOVIĆ, Tijana Žandarmerija, Beograd | 10 | 0 | FEHER, Zara SAMURAI FLORII DE CIRES, Voiniceni | 1:59 |
| 2 - 4 | ILIESKA, Matea Bušido, Prilep | 0 | 100 | MALEŠ, Mia TSK Temerin, Temerin | 0:06 |
| 3 - 5 | FEHER, Zara SAMURAI FLORII DE CIRES, Voiniceni | 100 | 0 | TRAJANOVSKI, Teodora Cement, Beočin | 0:06 |
| 1 - 4 | ŽIVANOVIĆ, Tijana Žandarmerija, Beograd | 100 | 0 | MALEŠ, Mia TSK Temerin, Temerin | 0:45 |
| 2 - 5 | ILIESKA, Matea Bušido, Prilep | 100 | 0 | TRAJANOVSKI, Teodora Cement, Beočin | 2:50 |

REZULTAT

| | |
|-------------------------|-----|
| 1. ŽIVANOVIĆ, Tijana | ŽAN |
| 2. FEHER, Zara | SFC |
| 3. MALEŠ, Mia | TSK |
| 3. ILIESKA, Matea | BUS |
| 5. TRAJANOVSKI, Teodora | CEM |

21. Međunarodni džudo turnir TURIJA 2019

Turija, 03.03.2019 - Starije poletarke



-43kg

5 takmičarki

| | TAKMIČAR | POBEDNIČKI BODOVI | | | | | POBEDA | BODOVA | MESTO |
|---|---|-------------------|-----|-----|-----|-----|--------|--------|-------|
| | | 1 | 2 | 3 | 4 | 5 | | | |
| 1 | MRAKOVIĆ, Una Crvena Zvezda, Beograd | | 100 | 100 | 100 | 100 | 4 | 400 | 1 |
| 2 | MEZEI, Emina Spartak, Subotica | 0 | | 100 | 0 | 100 | 2 | 200 | 2 |
| 3 | STEPIĆ, Ana Fajter, Obrenovac | 0 | 0 | | 0 | 100 | 1 | 100 | 3 |
| 4 | ILIĆ, Marija Jedinstvo, Kačarevo | 0 | 100 | 100 | | 0 | 2 | 200 | 3 |
| 5 | CRNJAKOV, Anđelija Turija, Turija | 0 | 0 | 0 | 100 | | 1 | 100 | 5 |

Bodovi: Ippon 100 / Wazaari 10 / Kazna 0.5

Redosled borbi: 1 - 2, 3 - 4 / 1 - 5, 2 - 3 / 4 - 5, 1 - 3 / 2 - 4, 3 - 5 / 1 - 4, 2 - 5

| BORBE | TAKMIČAR | BODOVA | BODOVA | TAKMIČAR | VREME |
|-------|---|--------|--------|--------------------------------------|-------|
| 1 - 2 | MRAKOVIĆ, Una Crvena Zvezda, Beograd | 100 | 0 | MEZEI, Emina Spartak, Subotica | 0:42 |
| 3 - 4 | STEPIĆ, Ana Fajter, Obrenovac | 0 | 100 | ILIĆ, Marija Jedinstvo, Kačarevo | 0:13 |
| 1 - 5 | MRAKOVIĆ, Una Crvena Zvezda, Beograd | 100 | 0 | CRNJAKOV, Anđelija Turija, Turija | 0:18 |
| 2 - 3 | MEZEI, Emina Spartak, Subotica | 100 | 0 | STEPIĆ, Ana Fajter, Obrenovac | 0:34 |
| 4 - 5 | ILIĆ, Marija Jedinstvo, Kačarevo | 0 | 100 | CRNJAKOV, Anđelija Turija, Turija | 1:39 |
| 1 - 3 | MRAKOVIĆ, Una Crvena Zvezda, Beograd | 100 | 0 | STEPIĆ, Ana Fajter, Obrenovac | 0:41 |
| 2 - 4 | MEZEI, Emina Spartak, Subotica | 0 | 100 | ILIĆ, Marija Jedinstvo, Kačarevo | 3:01 |
| 3 - 5 | STEPIĆ, Ana Fajter, Obrenovac | 100 | 0 | CRNJAKOV, Anđelija Turija, Turija | 0:26 |
| 1 - 4 | MRAKOVIĆ, Una Crvena Zvezda, Beograd | 100 | 0 | ILIĆ, Marija Jedinstvo, Kačarevo | 1:05 |
| 2 - 5 | MEZEI, Emina Spartak, Subotica | 100 | 0 | CRNJAKOV, Anđelija Turija, Turija | 0:37 |

REZULTAT

| | |
|-----------------------|-----|
| 1. MRAKOVIĆ, Una | CZB |
| 2. MEZEI, Emina | SPA |
| 3. ILIĆ, Marija | JED |
| 3. STEPIĆ, Ana | FAJ |
| 5. CRNJAKOV, Anđelija | TUR |

21. Međunarodni džudo turnir TURIJA 2019

Turija, 03.03.2019 - Starije poletarke

+43kg

4 takmičarki

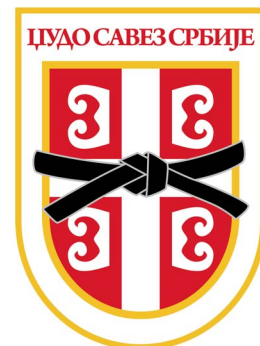

| | TAKMIČAR | POBEDNIČKI BODOVI | | | | POBEDA | BODOVA | MESTO |
|---|---|-------------------|-----|-----|-----|--------|--------|-------|
| | | 1 | 2 | 3 | 4 | | | |
| 1 | PAVIĆ, Lucia Voždovac, Beograd | | 100 | 100 | 100 | 3 | 300 | 1 |
| 2 | KOPRIVICA, Jovana Voždovac, Beograd | 0 | | 100 | 100 | 2 | 200 | 2 |
| 3 | ĆELBABIN, Mirjana Turija, Turija | 0 | 0 | | 0 | 0 | 0 | 3 |
| 4 | GIUCHIN, Nadia Judo Phoenix, Timisoara | 100 | 0 | 0 | | 1 | 100 | 3 |

Bodovi: Ippon 100 / Wazaari 10 / Kazna 0.5

Redosled borbi: 1 - 2, 3 - 4 / 1 - 3, 2 - 4 / 1 - 4, 2 - 3

| BORBE | TAKMIČAR | BODOVA | BODOVA | TAKMIČAR | VREME |
|-------|--|------------|------------|---|-------|
| 1 - 2 | PAVIĆ, Lucia Voždovac, Beograd | 100 | 0 | KOPRIVICA, Jovana Voždovac, Beograd | 0:19 |
| 3 - 4 | ĆELBABIN, Mirjana Turija, Turija | 0 | 100 | GIUCHIN, Nadia Judo Phoenix, Timisoara | 0:22 |
| 1 - 3 | PAVIĆ, Lucia Voždovac, Beograd | 100 | 0 | ĆELBABIN, Mirjana Turija, Turija | 0:05 |
| 2 - 4 | KOPRIVICA, Jovana Voždovac, Beograd | 100 | 0 | GIUCHIN, Nadia Judo Phoenix, Timisoara | 0:28 |
| 1 - 4 | PAVIĆ, Lucia Voždovac, Beograd | 100 | 0 | GIUCHIN, Nadia Judo Phoenix, Timisoara | 0:17 |
| 2 - 3 | KOPRIVICA, Jovana Voždovac, Beograd | 100 | 0 | ĆELBABIN, Mirjana Turija, Turija | 0:13 |

REZULTAT

| | |
|----------------------|-----|
| 1. PAVIĆ, Lucia | VOŽ |
| 2. KOPRIVICA, Jovana | VOŽ |
| 3. GIUCHIN, Nadia | PHO |
| 3. ĆELBABIN, Mirjana | TUR |

21. Međunarodni džudo turnir TURIJA 2019

Turija, 03.03.2019 - Mlađi pioniri

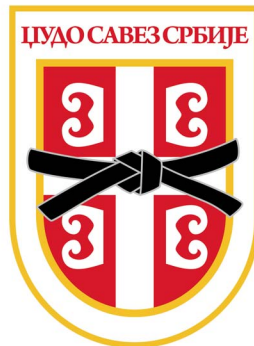

-30kg

16 takmičara

GRUPA A

| | | | | |
|----|--------------------|-----|---|--|
| 1 | NOVAKOVIĆ, Dejan | BAČ | 1 | NOVAKOVIĆ, Dejan Bačka, Sombor |
| 9 | STOKANOVIĆ, Vukan | SPA | | |
| 5 | VERUSEVSKI, Viktor | VOJ | 2 | GEORGIEV, Georgi MAKO RYU - DESANT, Bucharest |
| 13 | GEORGIEV, Georgi | MRD | | |

| | |
|----------------------------|-----------------------------------|
| 9 | NOVAKOVIĆ, Dejan Bačka, Sombor |
| GRUPA A - Pobjednik | |

GRUPA B

| | | | | |
|----|-------------------------|-----|---|---|
| 4 | ĆIRIĆ, Filip | DIN | 3 | ĆIRIĆ, Filip Dinamo, Pančevo |
| 12 | LIVIU, Andrei | MRD | | |
| 8 | MARIJANOVIĆ, Aleksandar | CZB | 4 | MARIJANOVIĆ, Aleksandar Crvena Zvezda, Beograd |
| 16 | BERČEK, Andrej | ZMA | | |

| | |
|----------------------------|---------------------------------|
| 10 | ĆIRIĆ, Filip Dinamo, Pančevo |
| GRUPA B - Pobjednik | |

GRUPA C

| | | | | |
|----|--------------------|-----|---|--|
| 2 | SUDAR, Luka | LOK | 5 | JAKOVLJEVIĆ, Jakša VGSK, Veliko Gradište |
| 10 | JAKOVLJEVIĆ, Jakša | VGS | | |
| 6 | LEHNI, Aleksa | JED | 6 | IANKOV, Teodor MAKO RYU - DESANT, Bucharest |
| 14 | IANKOV, Teodor | MRD | | |

| | |
|----------------------------|---|
| 11 | JAKOVLJEVIĆ, Jakša VGSK, Veliko Gradište |
| GRUPA C - Pobjednik | |

GRUPA D

| | | | | |
|----|---------------------|-----|---|--|
| 3 | SISAK, Daniel | SZJ | 7 | SISAK, Daniel Szatymaz judo, Szatymaz |
| 11 | GASPAR, Radu | PHO | | |
| 7 | JOKSIĆ, Mateja | VOJ | 8 | MLADENOVIĆ, Mihailo Bačka, Sombor |
| 15 | MLADENOVIĆ, Mihailo | BAČ | | |

| | |
|----------------------------|--------------------------------------|
| 12 | MLADENOVIĆ, Mihailo Bačka, Sombor |
| GRUPA D - Pobjednik | |

| | |
|----------------------------|-----------------------------------|
| 13 | NOVAKOVIĆ, Dejan Bačka, Sombor |
| GRUPA A - Pobjednik | |
| 19 | NOVAKOVIĆ, Dejan |
| 1. | |

| REZULTAT | |
|----------|-------------------------|
| 1. | NOVAKOVIĆ, Dejan BAČ |
| 2. | JAKOVLJEVIĆ, Jakša VGS |
| 3. | ĆIRIĆ, Filip DIN |
| 5. | SUDAR, Luka LOK |
| 5. | GEORGIEV, Georgi MRD |
| 5. | MLADENOVIĆ, Mihailo BAČ |
| 7. | STOKANOVIĆ, Vukan SPA |
| 7. | IANKOV, Teodor MRD |

REPASAŽ

| | | | | |
|--------------|-------------------|-----|----|--|
| [A1] | STOKANOVIĆ, Vukan | SPA | 15 | GEORGIEV, Georgi MAKO RYU - DESANT, Bucharest |
| [A2] | GEORGIEV, Georgi | MRD | | |
| 17 | | | | |
| ĆIRIĆ, Filip | | | | |
| 3. | | | | |

| | | | | |
|-------------|----------------|-----|----|----------------------------------|
| [C1] | SUDAR, Luka | LOK | 16 | SUDAR, Luka Lokomotiva, Vršac |
| [C2] | IANKOV, Teodor | MRD | | |
| 18 | | | | |
| SUDAR, Luka | | | | |
| 3. | | | | |

21. Međunarodni džudo turnir TURIJA 2019

Turija, 03.03.2019 - Mlađi pioniri



-34kg

24 takmičara

GRUPA A

| | | |
|----|-------------------|-----|
| 1 | STOKANOVIC, Ilija | SPA |
| 17 | | |
| 9 | ĐURĐEVIĆ, Matija | FAJ |
| 25 | GULIĆ, Sanjin | CEM |
| 5 | SEKULIĆ, Matija | VIN |
| 21 | | |
| 13 | BORKOVIĆ, Sergej | BAČ |
| 29 | LUKAČ, Dragiša | CZB |

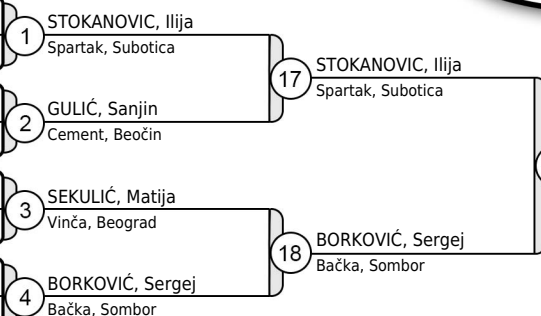

GRUPA A - Pobjednik

GRUPA B

| | | |
|----|---------------------|-----|
| 4 | PEŠIĆ, Ilija | RAK |
| 20 | | |
| 12 | MIJANOVIĆ, Miloš | DZU |
| 28 | PETROVIĆ, Mario | SLA |
| 8 | DRAGOJEVIĆ, Nemanja | BAČ |
| 24 | | |
| 16 | POPOV, Velimir | MRD |
| 32 | MARTINOVIĆ, Aleksa | TUR |

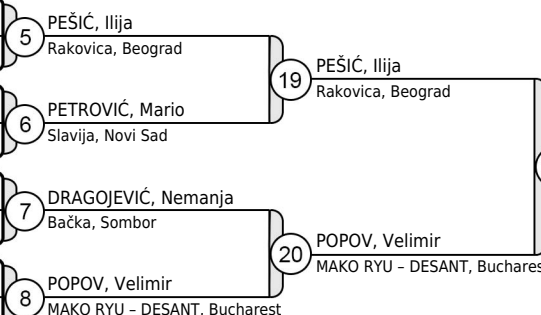

GRUPA B - Pobjednik

GRUPA C

| | | |
|----|------------------|-----|
| 2 | JANKOVIĆ, Boris | TKS |
| 18 | | |
| 10 | DOLINGA, Dejan | DIN |
| 26 | NOVAKOVIĆ, Luka | SIR |
| 6 | AVRAMOVIĆ, Vanja | RAK |
| 22 | | |
| 14 | MILIČIĆ, Mihailo | PKI |
| 30 | KRNDIJA, Aleksa | TSK |

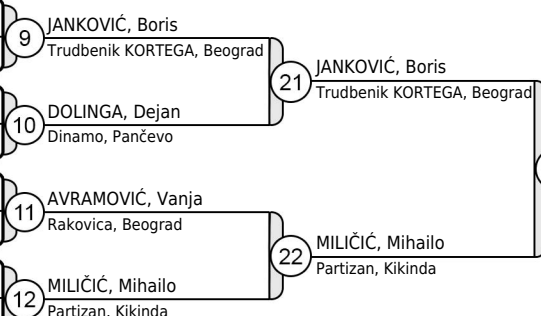

GRUPA C - Pobjednik

GRUPA D

| | | |
|----|--------------------|-----|
| 3 | MILJIĆ, Srđan | CEM |
| 19 | | |
| 11 | STOŠIĆ, Vasilije | JED |
| 27 | MENIČANIN, Radovan | SLA |
| 7 | VITKOVIĆ, Andrej | BAČ |
| 23 | | |
| 15 | SVRAKOV, Emil | MRD |
| 31 | IVANOVIĆ, Filip | SPA |

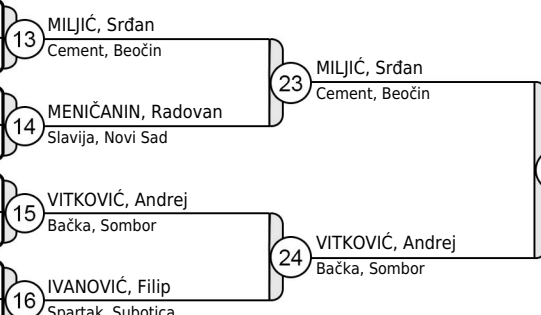

GRUPA D - Pobjednik

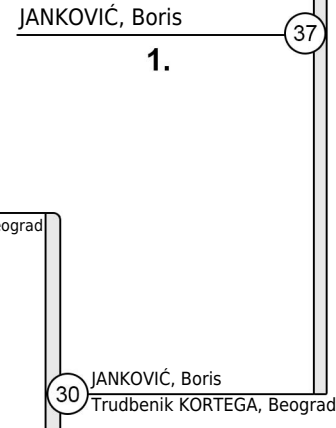

1.

REZULTAT

| | | |
|----|------------------|-----|
| 1. | JANKOVIĆ, Boris | TKS |
| 2. | PEŠIĆ, Ilija | RAK |
| 3. | BORKOVIĆ, Sergej | BAČ |
| 3. | VITKOVIĆ, Andrej | BAČ |
| 5. | POPOV, Velimir | MRD |
| 7. | PETROVIĆ, Mario | SLA |
| 7. | MILIČIĆ, Mihailo | PKI |

REPASAŽ

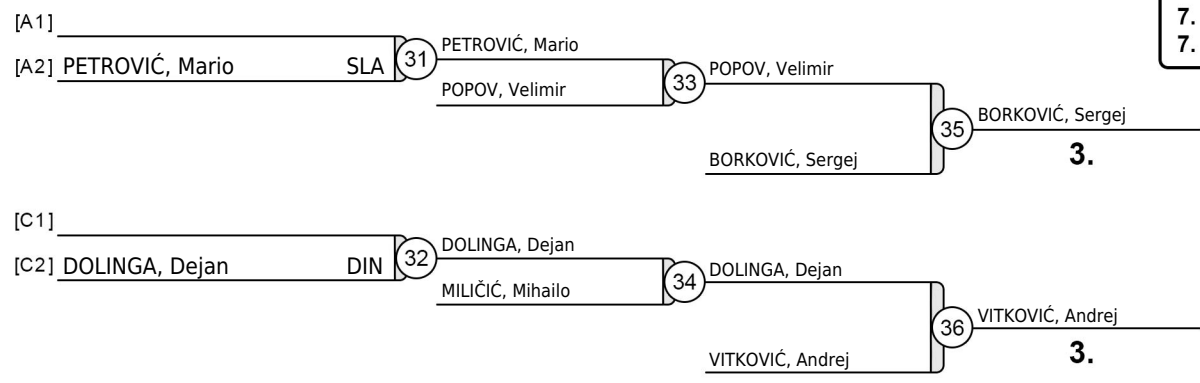

21. Međunarodni džudo turnir TURIJA 2019

Turija, 03.03.2019 - Mlađi pioniri



-38kg

18 takmičara

GRUPA A

| | | |
|----|----------------------|-----|
| 1 | MIRKOVIĆ, Nikola | DIN |
| 17 | | |
| 9 | VUKAŠINOVIĆ, Bogdan | IPO |
| 25 | | |
| 5 | STOJADINOVIĆ, Viktor | FAJ |
| 21 | | |
| 13 | NEACSU, Erik | MRD |
| 29 | | |

| | | |
|----|----------------------|------------------------------|
| 1 | MIRKOVIĆ, Nikola | Dinamo, Pančevo |
| 2 | VUKAŠINOVIĆ, Bogdan | Ipon, Sombor |
| 3 | STOJADINOVIĆ, Viktor | Fajter, Obrenovac |
| 4 | NEACSU, Erik | MAKO RYU - DESANT, Bucharest |
| 17 | MIRKOVIĆ, Nikola | Dinamo, Pančevo |
| 18 | STOJADINOVIĆ, Viktor | Fajter, Obrenovac |
| 25 | MIRKOVIĆ, Nikola | Dinamo, Pančevo |

GRUPA A - Pobjednik

GRUPA B

| | | |
|----|---------------------|-----|
| 4 | JOVANOVIĆ, Nikola | TUR |
| 20 | | |
| 12 | CVETKOVIĆ, Gvozden | VIN |
| 28 | MANOJLOVIĆ, Dušan | CZB |
| 8 | KOLAROV, Aleksandar | VOJ |
| 24 | | |
| 16 | PETROVIĆ, Mihailo | SLA |
| 32 | | |

| | | |
|----|---------------------|---------------------|
| 5 | JOVANOVIĆ, Nikola | Turija, Turija |
| 6 | CVETKOVIĆ, Gvozden | Vinča, Beograd |
| 7 | KOLAROV, Aleksandar | Vojvodina, Novi Sad |
| 8 | PETROVIĆ, Mihailo | Slavija, Novi Sad |
| 19 | JOVANOVIĆ, Nikola | Turija, Turija |
| 20 | KOLAROV, Aleksandar | Vojvodina, Novi Sad |
| 26 | JOVANOVIĆ, Nikola | Turija, Turija |

GRUPA B - Pobjednik

GRUPA C

| | | |
|----|---------------------|-----|
| 2 | LUPULOV, Aleksandar | VIN |
| 18 | | |
| 10 | MARKI, Mario | DZU |
| 26 | | |
| 6 | MITIĆ, Nikola | DIN |
| 22 | | |
| 14 | ADAM, Darko | TSK |
| 30 | | |

| | | |
|----|---------------------|----------------------|
| 9 | LUPULOV, Aleksandar | Vinča, Beograd |
| 10 | MARKI, Mario | Džuns, Novi Sad |
| 11 | MITIĆ, Nikola | Dinamo, Pančevo |
| 12 | ADAM, Darko | TSK Temerin, Temerin |
| 21 | LUPULOV, Aleksandar | Vinča, Beograd |
| 22 | ADAM, Darko | TSK Temerin, Temerin |
| 27 | LUPULOV, Aleksandar | Vinča, Beograd |

GRUPA C - Pobjednik

GRUPA D

| | | |
|----|------------------|-----|
| 3 | TOPIĆ, Dušan | BAČ |
| 19 | | |
| 11 | BENIŠEK, Filip | RAK |
| 27 | MARIĆ, Andrija | CZB |
| 7 | VELIČKOVIĆ, Luka | FAJ |
| 23 | | |
| 15 | DURNEA, Sorin | PHO |
| 31 | | |

| | | |
|----|------------------|-------------------------|
| 13 | TOPIĆ, Dušan | Bačka, Sombor |
| 14 | MARIĆ, Andrija | Crvena Zvezda, Beograd |
| 15 | VELIČKOVIĆ, Luka | Fajter, Obrenovac |
| 16 | DURNEA, Sorin | Judo Phoenix, Timisoara |
| 23 | TOPIĆ, Dušan | Bačka, Sombor |
| 24 | VELIČKOVIĆ, Luka | Fajter, Obrenovac |
| 28 | TOPIĆ, Dušan | Bačka, Sombor |

GRUPA D - Pobjednik

LUPULOV, Aleksandar

1.

LUPULOV, Aleksandar
Vinča, Beograd

REZULTAT

| | | |
|----|---------------------|-----|
| 1. | LUPULOV, Aleksandar | VIN |
| 2. | JOVANOVIĆ, Nikola | TUR |
| 3. | MIRKOVIĆ, Nikola | DIN |
| 3. | ADAM, Darko | TSK |
| 5. | CVETKOVIĆ, Gvozden | VIN |
| 5. | TOPIĆ, Dušan | BAČ |
| 7. | KOLAROV, Aleksandar | VOJ |
| 7. | MARKI, Mario | DZU |

REPASAŽ

| | | |
|------|--------------------|---------------------|
| [A1] | | CVETKOVIĆ, Gvozden |
| [A2] | CVETKOVIĆ, Gvozden | VIN |
| | | KOLAROV, Aleksandar |
| | | CVETKOVIĆ, Gvozden |
| | | MIRKOVIĆ, Nikola |
| | | MIRKOVIĆ, Nikola |
| | | 3. |

| | | |
|------|--------------|--------------|
| [C1] | | MARKI, Mario |
| [C2] | MARKI, Mario | DZU |
| | | ADAM, Darko |
| | | ADAM, Darko |
| | | ADAM, Darko |
| | | TOPIĆ, Dušan |
| | | 3. |

21. Međunarodni džudo turnir TURIJJA 2019

Turija, 03.03.2019 - Mlađi pioniri



-42kg

19 takmičara

GRUPA A

| | | |
|----|-------------------|-----|
| 1 | MILANOVIĆ, Veljko | OML |
| 17 | | |
| 9 | ZOROJA, Sergej | BAČ |
| 25 | MIŠELJIĆ, Miloš | TSK |
| 5 | SAVIĆ, Aleksa | CZB |
| 21 | | |
| 13 | ĐEKIĆ, Jovan | SLA |
| 29 | | |



MILANOVIĆ, Veljko
Omladinac, Stepanovićevo
GRUPA A - Pobjednik

GRUPA B

| | | |
|----|------------------|-----|
| 4 | VARNIČIĆ, Veljko | TKS |
| 20 | | |
| 12 | UGARAK, Uroš | CZB |
| 28 | | |
| 8 | MATIĆ, Nemanja | JUG |
| 24 | | |
| 16 | JEŠIĆ, Filip | SRS |
| 32 | | |

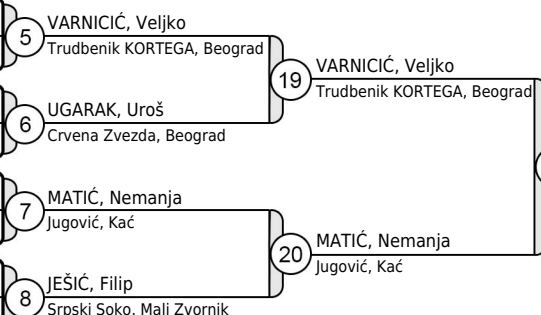

VARNIČIĆ, Veljko
Trudbenik KORTEGA, Beograd
GRUPA B - Pobjednik

GRUPA C

| | | |
|----|-----------------|-----|
| 2 | SOKIĆ, Vukašin | CZB |
| 18 | | |
| 10 | TERENJI, Romeo | PKO |
| 26 | RAKIN, Vladimir | OML |
| 6 | PUPOVAC, Uroš | RAK |
| 22 | | |
| 14 | MAKSIĆ, Stefan | IPO |
| 30 | | |

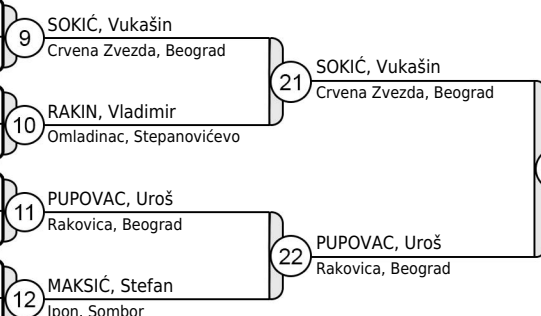

SOKIĆ, Vukašin
Crvena Zvezda, Beograd
GRUPA C - Pobjednik

GRUPA D

| | | |
|----|---------------------|-----|
| 3 | ZABUNOVIĆ, Vasilije | RAK |
| 19 | | |
| 11 | RONČEVIĆ, Aleksej | BAČ |
| 27 | ĆURČIĆ, David | TUR |
| 7 | MUDRIĆ, Aleksa | ŽAN |
| 23 | | |
| 15 | BENEA, Nicolas | PHO |
| 31 | | |

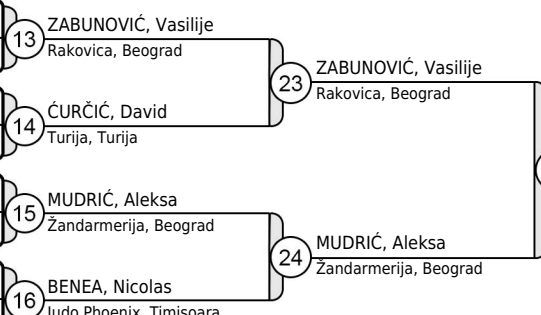

MUDRIĆ, Aleksa
Žandarmerija, Beograd
GRUPA D - Pobjednik

MILANOVIĆ, Veljko
1.

| REZULTAT | |
|----------|-----------------------|
| 1. | MILANOVIĆ, Veljko OML |
| 2. | SOKIĆ, Vukašin CZB |
| 3. | VARNIČIĆ, Veljko TKS |
| 3. | PUPOVAC, Uroš RAK |
| 5. | SAVIĆ, Aleksa CZB |
| 5. | MUDRIĆ, Aleksa ŽAN |
| 7. | MIŠELJIĆ, Miloš TSK |
| 7. | RAKIN, Vladimir OML |

REPASAŽ

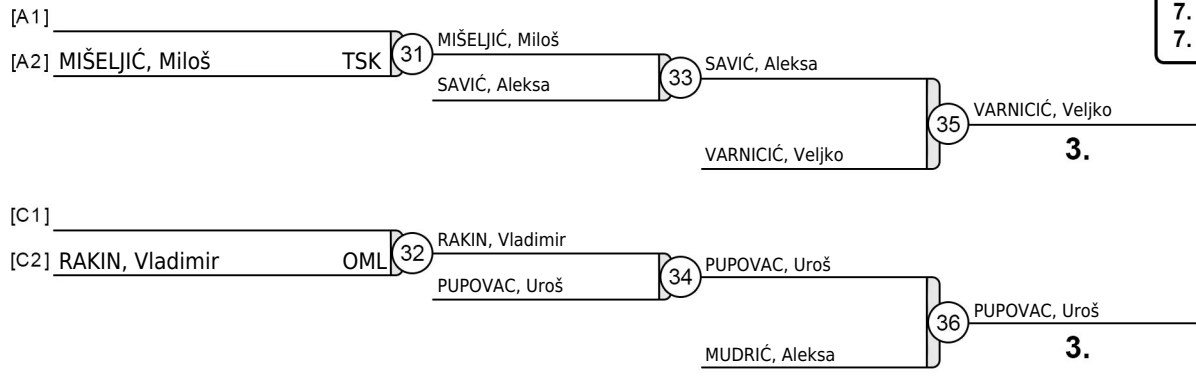

21. Međunarodni džudo turnir TURIJA 2019

Turija, 03.03.2019 - Mlađi pioniri



-46kg

11 takmičara

GRUPA A

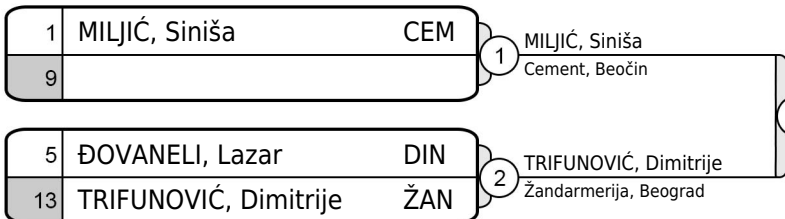

9 MILJIĆ, Siniša
Cement, Beočin
GRUPA A - Pobjednik

GRUPA B

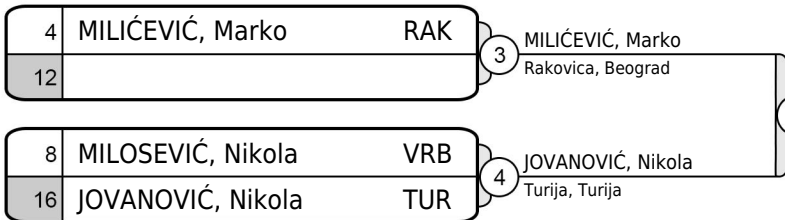

10 MILIĆEVIĆ, Marko
Rakovica, Beograd
GRUPA B - Pobjednik

GRUPA C

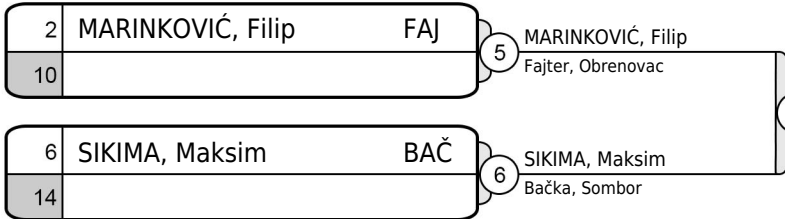

11 SIKIMA, Maksim
Bačka, Sombor
GRUPA C - Pobjednik

GRUPA D

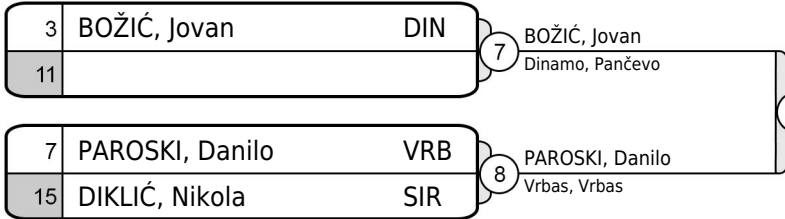

12 PAROSKI, Danilo
Vrbas, Vrbas
GRUPA D - Pobjednik

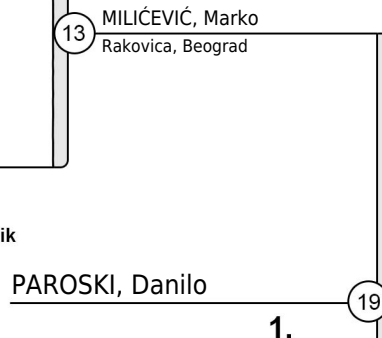

REPASAŽ

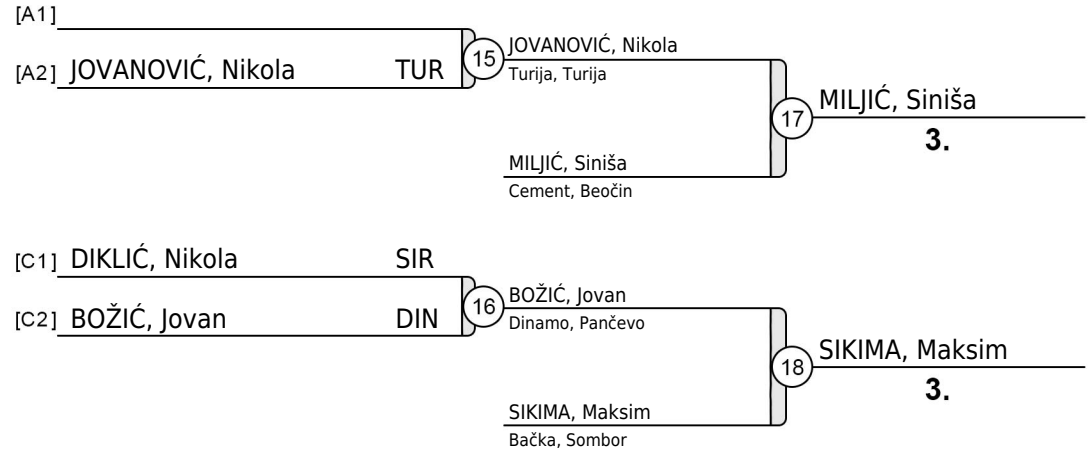

REZULTAT

- | | | |
|----|-------------------|-----|
| 1. | PAROSKI, Danilo | VRB |
| 2. | MILIĆEVIĆ, Marko | RAK |
| 3. | MILJIĆ, Siniša | CEM |
| 3. | SIKIMA, Maksim | BAČ |
| 5. | JOVANOVIĆ, Nikola | TUR |
| 5. | BOŽIĆ, Jovan | DIN |
| 7. | | |
| 7. | DIKLIĆ, Nikola | SIR |

21. Međunarodni džudo turnir TURIJA 2019

Turija, 03.03.2019 - Mlađi pioniri



-50kg

9 takmičara

GRUPA A

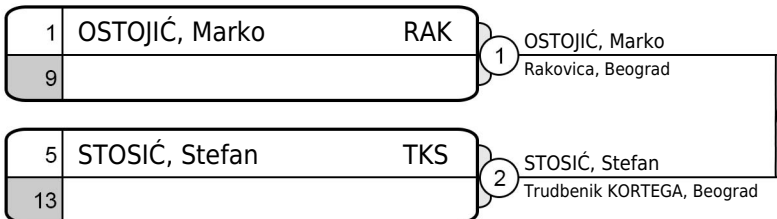

OSTOJIĆ, Marko
Rakovica, Beograd

GRUPA A - Pobjednik

GRUPA B

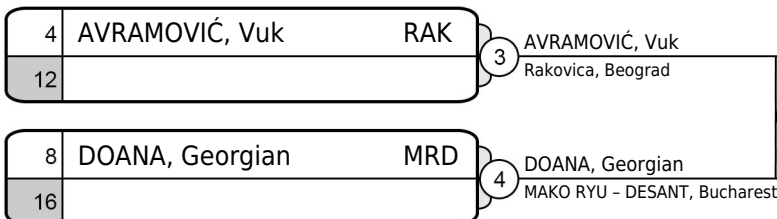

DOANA, Georgian
MAKO RYU - DESANT, Bucharest

GRUPA B - Pobjednik

GRUPA C

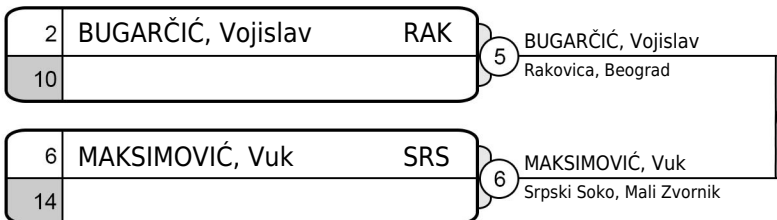

BUGARČIĆ, Vojislav
Rakovica, Beograd

GRUPA C - Pobjednik

GRUPA D

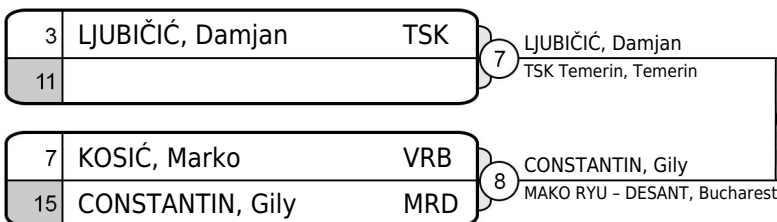

CONSTANTIN, Gily
MAKO RYU - DESANT, Bucharest

GRUPA D - Pobjednik

OSTOJIĆ, Marko

1.

BUGARČIĆ, Vojislav
Rakovica, Beograd

REZULTAT

| | | |
|----|--------------------|-----|
| 1. | OSTOJIĆ, Marko | RAK |
| 2. | BUGARČIĆ, Vojislav | RAK |
| 3. | DOANA, Georgian | MRD |
| 3. | CONSTANTIN, Gily | MRD |
| 5. | STOSIĆ, Stefan | TKS |
| 5. | MAKSIMOVIĆ, Vuk | SRS |
| 7. | | |
| 7. | | |

REPASAŽ

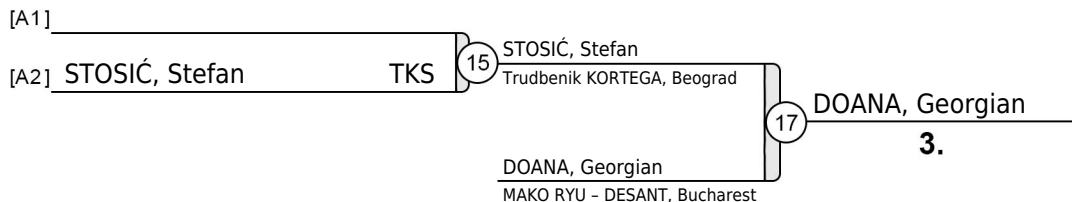

21. Međunarodni džudo turnir TURIJIA 2019

Turija, 03.03.2019 - Mlađi pioniri



-55kg

5 takmičara

| | TAKMIČAR | POBEDNIČKI BODOVI | | | | | POBEDA | BODOVA | MESTO |
|---|---|-------------------|---|-----|-----|-----|--------|--------|-------|
| | | 1 | 2 | 3 | 4 | 5 | | | |
| 1 | RUŠIĆ, Stefan Obrenovac, Obrenovac | | 0 | 100 | 0 | 100 | 2 | 200 | 2 |
| 2 | BUTA, Denis MAKO RYU - DESANT, Bucharest | 100 | | 100 | 100 | 100 | 4 | 400 | 1 |
| 3 | BAJIN, Marko Omladinac, Stepanovićevo | 0 | 0 | | 100 | 100 | 2 | 200 | 3 |
| 4 | MITROVIĆ, Vuk Turija, Turija | 100 | 0 | 0 | | 0 | 1 | 100 | 5 |
| 5 | MARIĆ, Luka Crvena Zvezda, Beograd | 0 | 0 | 0 | 100 | | 1 | 100 | 3 |

Bodovi: Ippon 100 / Wazaari 10 / Kazna 0.5

Redosled borbi: 1 - 2, 3 - 4 / 1 - 5, 2 - 3 / 4 - 5, 1 - 3 / 2 - 4, 3 - 5 / 1 - 4, 2 - 5

| BORBE | TAKMIČAR | BODOVA | BODOVA | TAKMIČAR | VREME |
|-------|---|------------|------------|---|-------|
| 1 - 2 | RUŠIĆ, Stefan Obrenovac, Obrenovac | 0 | 100 | BUTA, Denis MAKO RYU - DESANT, Bucharest | 0:09 |
| 3 - 4 | BAJIN, Marko Omladinac, Stepanovićevo | 100 | 0 | MITROVIĆ, Vuk Turija, Turija | 0:04 |
| 1 - 5 | RUŠIĆ, Stefan Obrenovac, Obrenovac | 100 | 0 | MARIĆ, Luka Crvena Zvezda, Beograd | 2:48 |
| 2 - 3 | BUTA, Denis MAKO RYU - DESANT, Bucharest | 100 | 0 | BAJIN, Marko Omladinac, Stepanovićevo | 0:06 |
| 4 - 5 | MITROVIĆ, Vuk Turija, Turija | 0 | 100 | MARIĆ, Luka Crvena Zvezda, Beograd | 2:36 |
| 1 - 3 | RUŠIĆ, Stefan Obrenovac, Obrenovac | 100 | 0 | BAJIN, Marko Omladinac, Stepanovićevo | 1:16 |
| 2 - 4 | BUTA, Denis MAKO RYU - DESANT, Bucharest | 100 | 0 | MITROVIĆ, Vuk Turija, Turija | 1:34 |
| 3 - 5 | BAJIN, Marko Omladinac, Stepanovićevo | 100 | 0 | MARIĆ, Luka Crvena Zvezda, Beograd | 2:19 |
| 1 - 4 | RUŠIĆ, Stefan Obrenovac, Obrenovac | 0 | 100 | MITROVIĆ, Vuk Turija, Turija | 0:21 |
| 2 - 5 | BUTA, Denis MAKO RYU - DESANT, Bucharest | 100 | 0 | MARIĆ, Luka Crvena Zvezda, Beograd | 1:15 |

REZULTAT

| | |
|------------------|-----|
| 1. BUTA, Denis | MRD |
| 2. RUŠIĆ, Stefan | OBR |
| 3. BAJIN, Marko | OML |
| 3. MARIĆ, Luka | CZB |
| 5. MITROVIĆ, Vuk | TUR |

21. Međunarodni džudo turnir TURIJA 2019

Turija, 03.03.2019 - Mlađi pioniri



-60kg

7 takmičara

GRUPA A

1 MICIĆ, Jovan DZU
9

1 MICIĆ, Jovan
Džuns, Novi Sad

5 MALEŠ, Luka JUG
13

2 MALEŠ, Luka
Jugović, Kač

9 MICIĆ, Jovan
Džuns, Novi Sad

GRUPA A - Pobjednik

GRUPA B

4 OBRADOVIĆ, Nikola TKS
12

3 OBRADOVIĆ, Nikola
Trudbenik KORTEGA, Beograd

8 TOT, Roland TUR
16

4 TOT, Roland
Turija, Turija

10 OBRADOVIĆ, Nikola
Trudbenik KORTEGA, Beograd

GRUPA B - Pobjednik

MICIĆ, Jovan

13 MICIĆ, Jovan
Džuns, Novi Sad

1.

GRUPA C

2 KUKOLJ, Stefan FAJ
10

5 KUKOLJ, Stefan
Fajter, Obrenovac

6 MICESKI, David BUS
14

6 MICESKI, David
Bušido, Prilep

11 KUKOLJ, Stefan
Fajter, Obrenovac

GRUPA C - Pobjednik

14 PETROVIĆ, Kristijan
Zmaj, Srpski Krstur

GRUPA D

3 PETROVIĆ, Kristijan ZMA
11

7 PETROVIĆ, Kristijan
Zmaj, Srpski Krstur

7
15

8

12 PETROVIĆ, Kristijan
Zmaj, Srpski Krstur

GRUPA D - Pobjednik

REZULTAT

- | | | |
|----|---------------------|-----|
| 1. | MICIĆ, Jovan | DZU |
| 2. | PETROVIĆ, Kristijan | ZMA |
| 3. | OBRADOVIĆ, Nikola | TKS |
| 3. | KUKOLJ, Stefan | FAJ |
| 5. | MALEŠ, Luka | JUG |
| 7. | | |
| 7. | | |

REPASAŽ

[A1]
[A2] MALEŠ, Luka JUG

15 MALEŠ, Luka
Jugović, Kač

17 OBRADOVIĆ, Nikola

3.

OBRADOVIĆ, Nikola
Trudbenik KORTEGA, Beograd

[C1]
[C2]

16

18 KUKOLJ, Stefan

3.

KUKOLJ, Stefan
Fajter, Obrenovac

21. Međunarodni džudo turnir TURIJA 2019

Turija, 03.03.2019 - Mlađi pioniri

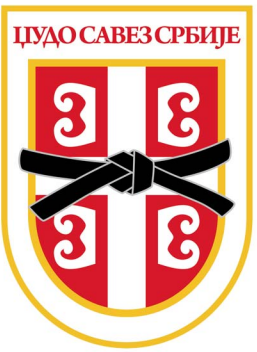

-66kg

3 takmičara

| | TAKMIČAR | POBEDNIČKI BODOVI | | | POBEDA | BODOVA | MESTO |
|---|--|-------------------|-----|-----|--------|--------|-------|
| | | 1 | 2 | 3 | | | |
| 1 | ORLIĆ, Nikola Jugović, Kač | | 100 | 100 | 2 | 200 | 1 |
| 2 | ŠUŠA, Nemanja Ipon, Sombor | 0 | | 0 | 0 | 0 | 3 |
| 3 | VUKOSALJEVIĆ, Tanasko Srpski Soko, Mali Zvornik | 0 | 100 | | 1 | 100 | 2 |

BODOVI: Ippon 100 / Wazaari 10 / Kazna 0.5

Redosled borbi: 1 - 2 / 1 - 3 / 2 - 3

| BORBE | TAKMIČAR | BODOVA | BODOVA | TAKMIČAR | VREME |
|-------|-------------------------------|--------|--------|--|-------|
| 1 - 2 | ORLIĆ, Nikola Jugović, Kač | 100 | 0 | ŠUŠA, Nemanja Ipon, Sombor | 1:06 |
| 1 - 3 | ORLIĆ, Nikola Jugović, Kač | 100 | 0 | VUKOSALJEVIĆ, Tanasko Srpski Soko, Mali Zvornik | 2:08 |
| 2 - 3 | ŠUŠA, Nemanja Ipon, Sombor | 0 | 100 | VUKOSALJEVIĆ, Tanasko Srpski Soko, Mali Zvornik | 1:56 |

REZULTAT

1. ORLIĆ, Nikola JUG
2. VUKOSALJEVIĆ, Tanasko SRS
3. ŠUŠA, Nemanja IPO

21. Međunarodni džudo turnir TURIJA 2019

Turija, 03.03.2019 - Mlađi pioniri



+66kg

5 takmičara

| | TAKMIČAR | POBEDNIČKI BODOVI | | | | | POBEDA | BODOVA | MESTO |
|---|--|-------------------|-----|-----|-----|-----|--------|--------|-------|
| | | 1 | 2 | 3 | 4 | 5 | | | |
| 1 | PETKOVIĆ, Miljan Partizan, Kikinda | | 100 | 100 | 100 | 100 | 4 | 400 | 1 |
| 2 | PERKOVIĆ, David Sirmijum, Sremska Mitrovica | 0 | | 100 | 100 | 100 | 3 | 300 | 2 |
| 3 | PETKOVIĆ, Simon Partizan, Kikinda | 0 | 0 | | 100 | 0 | 1 | 100 | 3 |
| 4 | STEPANOVIĆ, Miloš Tori, Vrbas | 0 | 0 | 0 | | 0 | 0 | 0 | 5 |
| 5 | REPAC, Marko Jugović, Kač | 0 | 0 | 100 | 10 | | 2 | 110 | 3 |

Bodovi: Ippon 100 / Wazaari 10 / Kazna 0.5

Redosled borbi: 1 - 2, 3 - 4 / 1 - 5, 2 - 3 / 4 - 5, 1 - 3 / 2 - 4, 3 - 5 / 1 - 4, 2 - 5

| BORBE | TAKMIČAR | BODOVA | BODOVA | TAKMIČAR | VREME |
|-------|--|------------|------------|--|-------|
| 1 - 2 | PETKOVIĆ, Miljan Partizan, Kikinda | 100 | 0 | PERKOVIĆ, David Sirmijum, Sremska Mitrovica | 1:56 |
| 3 - 4 | PETKOVIĆ, Simon Partizan, Kikinda | 100 | 0 | STEPANOVIĆ, Miloš Tori, Vrbas | 1:47 |
| 1 - 5 | PETKOVIĆ, Miljan Partizan, Kikinda | 100 | 0 | REPAC, Marko Jugović, Kač | 0:43 |
| 2 - 3 | PERKOVIĆ, David Sirmijum, Sremska Mitrovica | 100 | 0 | PETKOVIĆ, Simon Partizan, Kikinda | 1:59 |
| 4 - 5 | STEPANOVIĆ, Miloš Tori, Vrbas | 0 | 10 | REPAC, Marko Jugović, Kač | 2:36 |
| 1 - 3 | PETKOVIĆ, Miljan Partizan, Kikinda | 100 | 0 | PETKOVIĆ, Simon Partizan, Kikinda | 1:05 |
| 2 - 4 | PERKOVIĆ, David Sirmijum, Sremska Mitrovica | 100 | 0 | STEPANOVIĆ, Miloš Tori, Vrbas | 0:34 |
| 3 - 5 | PETKOVIĆ, Simon Partizan, Kikinda | 0 | 100 | REPAC, Marko Jugović, Kač | 1:02 |
| 1 - 4 | PETKOVIĆ, Miljan Partizan, Kikinda | 100 | 0 | STEPANOVIĆ, Miloš Tori, Vrbas | 0:36 |
| 2 - 5 | PERKOVIĆ, David Sirmijum, Sremska Mitrovica | 100 | 0 | REPAC, Marko Jugović, Kač | 0:37 |

REZULTAT

- | | |
|----------------------|-----|
| 1. PETKOVIĆ, Miljan | PKI |
| 2. PERKOVIĆ, David | SIR |
| 3. REPAC, Marko | JUG |
| 3. PETKOVIĆ, Simon | PKI |
| 5. STEPANOVIĆ, Miloš | TOR |

21. Međunarodni džudo turnir TURIJA 2019

Turija, 03.03.2019 - Mlađe pionirke



-32kg

9 takmičarki

GRUPA A

1 PROLIĆ, Natalija CEM
9

1 PROLIĆ, Natalija
Cement, Beočin

5 HERŠČAK, Andreja PNS
13

2 HERŠČAK, Andreja
Partizan, Novi Sad

9 PROLIĆ, Natalija
Cement, Beočin

GRUPA A - Pobjednik

GRUPA B

4 TOMIĆ, Katarina SIR
12

3 TOMIĆ, Katarina
Sirmijum, Sremska Mitrovica

8 JOVANOVIĆ, Anja ŽAN
16

4 JOVANOVIĆ, Anja
Žandarmerija, Beograd

10 JOVANOVIĆ, Anja
Žandarmerija, Beograd

GRUPA B - Pobjednik

13 PROLIĆ, Natalija
Cement, Beočin

SAVIĆ, Bojana

1.

GRUPA C

2 SAVIĆ, Bojana RAK
10

5 SAVIĆ, Bojana
Rakovica, Beograd

6 SAMARDŽIĆ, Adrijana TUR
14

6 SAMARDŽIĆ, Adrijana
Turija, Turija

11 SAVIĆ, Bojana
Rakovica, Beograd

GRUPA C - Pobjednik

14 SAVIĆ, Bojana
Rakovica, Beograd

GRUPA D

3 POZNANOVIĆ, Ekaterina CZB
11

7 POZNANOVIĆ, Ekaterina
Crvena Zvezda, Beograd

7 SPERLEA, Briana PHO
15
MILICA, Katona CEM

8 SPERLEA, Briana
Judo Phoenix, Timisoara

12 SPERLEA, Briana
Judo Phoenix, Timisoara

GRUPA D - Pobjednik

REZULTAT

- | | | |
|----|---------------------|-----|
| 1. | SAVIĆ, Bojana | RAK |
| 2. | PROLIĆ, Natalija | CEM |
| 3. | JOVANOVIĆ, Anja | ŽAN |
| 3. | SPERLEA, Briana | PHO |
| 5. | HERŠČAK, Andreja | PNS |
| 5. | SAMARDŽIĆ, Adrijana | TUR |
| 7. | | |
| 7. | | |

REPASAŽ

[A1] _____
[A2] HERŠČAK, Andreja PNS

15 HERŠČAK, Andreja
Partizan, Novi Sad

17 JOVANOVIĆ, Anja

3.

JOVANOVIĆ, Anja
Žandarmerija, Beograd

[C1] _____
[C2] SAMARDŽIĆ, Adrijana TUR

16 SAMARDŽIĆ, Adrijana
Turija, Turija

18 SPERLEA, Briana

3.

SPERLEA, Briana
Judo Phoenix, Timisoara

21. Međunarodni džudo turnir TURIJA 2019

Turija, 03.03.2019 - Mlađe pionirke



-36kg

6 takmičarki

| BORBE | TAKMIČAR | BODOVA | BODOVA | TAKMIČAR | VREME |
|-------|-------------------------------------|--------|--------|--|-------|
| 1 - 2 | ORLOVIĆ, Olga Partizan, Novi Sad | 100 | 0 | ŠIBUL, Milana Partizan, Kikinda | 0:08 |
| 1 - 3 | ORLOVIĆ, Olga Partizan, Novi Sad | 100 | 0 | ŠTAJNFELD, Sara Zmaj, Srpski Krstur | 1:07 |
| 2 - 3 | ŠIBUL, Milana Partizan, Kikinda | 100 | 0 | ŠTAJNFELD, Sara Zmaj, Srpski Krstur | 0:10 |



| BORBE | TAKMIČAR | BODOVA | BODOVA | TAKMIČAR | VREME |
|-------|--|--------|--------|--|-------|
| 4 - 5 | JOVOVIĆ, Jovana Rakovica, Beograd | 100 | 0 | STOJIĆEVIĆ, Teodora VGSK, Veliko Gradište | 2:03 |
| 4 - 6 | JOVOVIĆ, Jovana Rakovica, Beograd | 100 | 0 | CAZACU, Andrea MAKO RYU - DESANT, Bucharest | 0:59 |
| 5 - 6 | STOJIĆEVIĆ, Teodora VGSK, Veliko Gradište | 100 | 0 | CAZACU, Andrea MAKO RYU - DESANT, Bucharest | 0:30 |

BODOVI: Ippon 100 / Wazaari 10 / Kazna 0.5

Redosled borbi: 1 - 2 / 4 - 5 / 1 - 3 / 4 - 6 / 2 - 3 / 5 - 6

REZULTAT

| | |
|------------------------|-----|
| 1. ORLOVIĆ, Olga | PNS |
| 2. JOVOVIĆ, Jovana | RAK |
| 3. STOJIĆEVIĆ, Teodora | VGS |
| 3. ŠIBUL, Milana | PKI |
| 5. ŠTAJNFELD, Sara | ZMA |
| 5. CAZACU, Andrea | MRD |

21. Međunarodni džudo turnir TURIJA 2019

Turija, 03.03.2019 - Mlađe pionirke

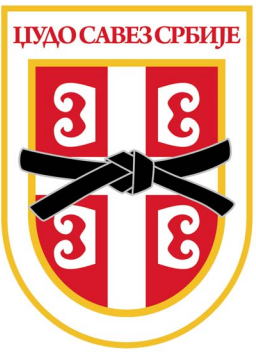

-40kg

11 takmičarki

GRUPA A

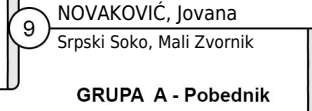
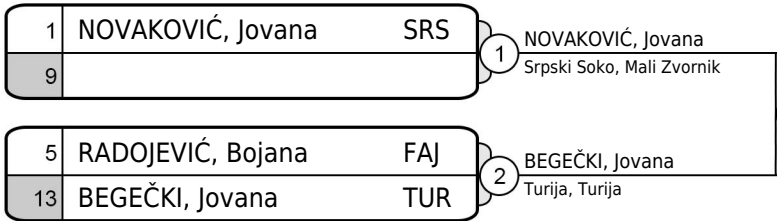

GRUPA B

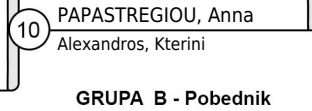
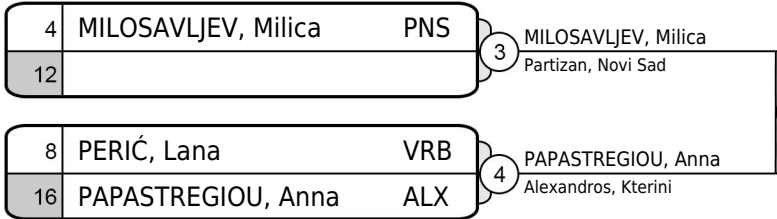

GRUPA C

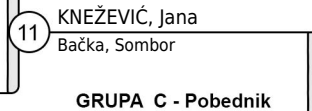
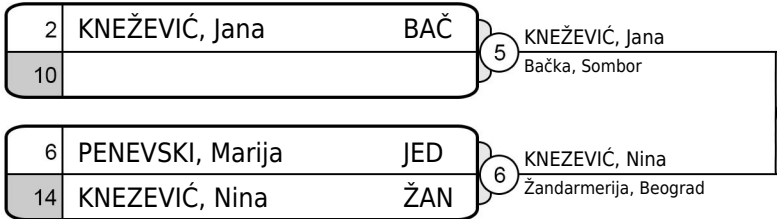

GRUPA D

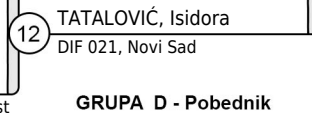
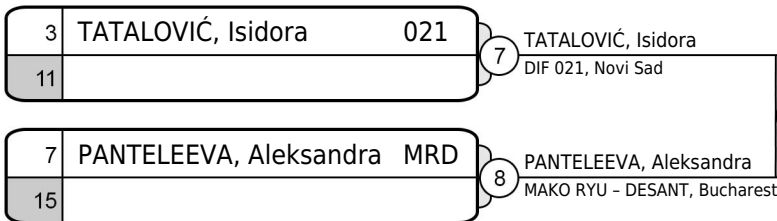

NOVAKOVIĆ, Jovana
1.

| REZULTAT | | |
|----------|------------------------|-----|
| 1. | NOVAKOVIĆ, Jovana | SRS |
| 2. | TATALOVIĆ, Isidora | 021 |
| 3. | PAPASTREGIOU, Anna | ALX |
| 3. | KNEŽEVIĆ, Jana | BAČ |
| 5. | BEGEČKI, Jovana | TUR |
| 5. | PANTELEEVA, Aleksandra | MRD |
| 7. | | |
| 7. | | |

REPASAŽ

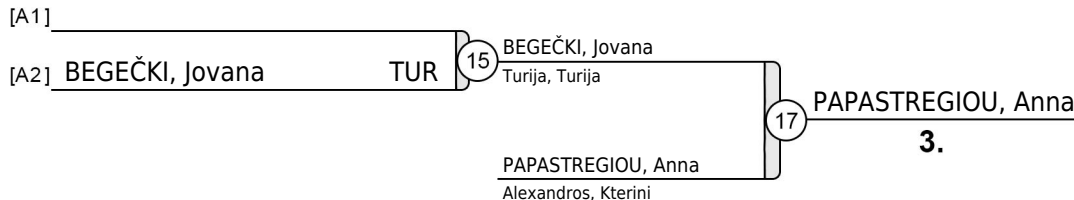

21. Međunarodni džudo turnir TURIJA 2019

Turija, 03.03.2019 - Mlađe pionirke

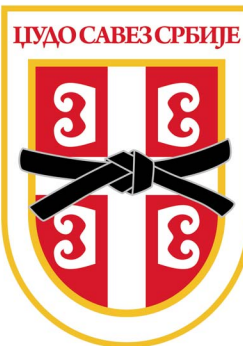

-44kg

7 takmičarki

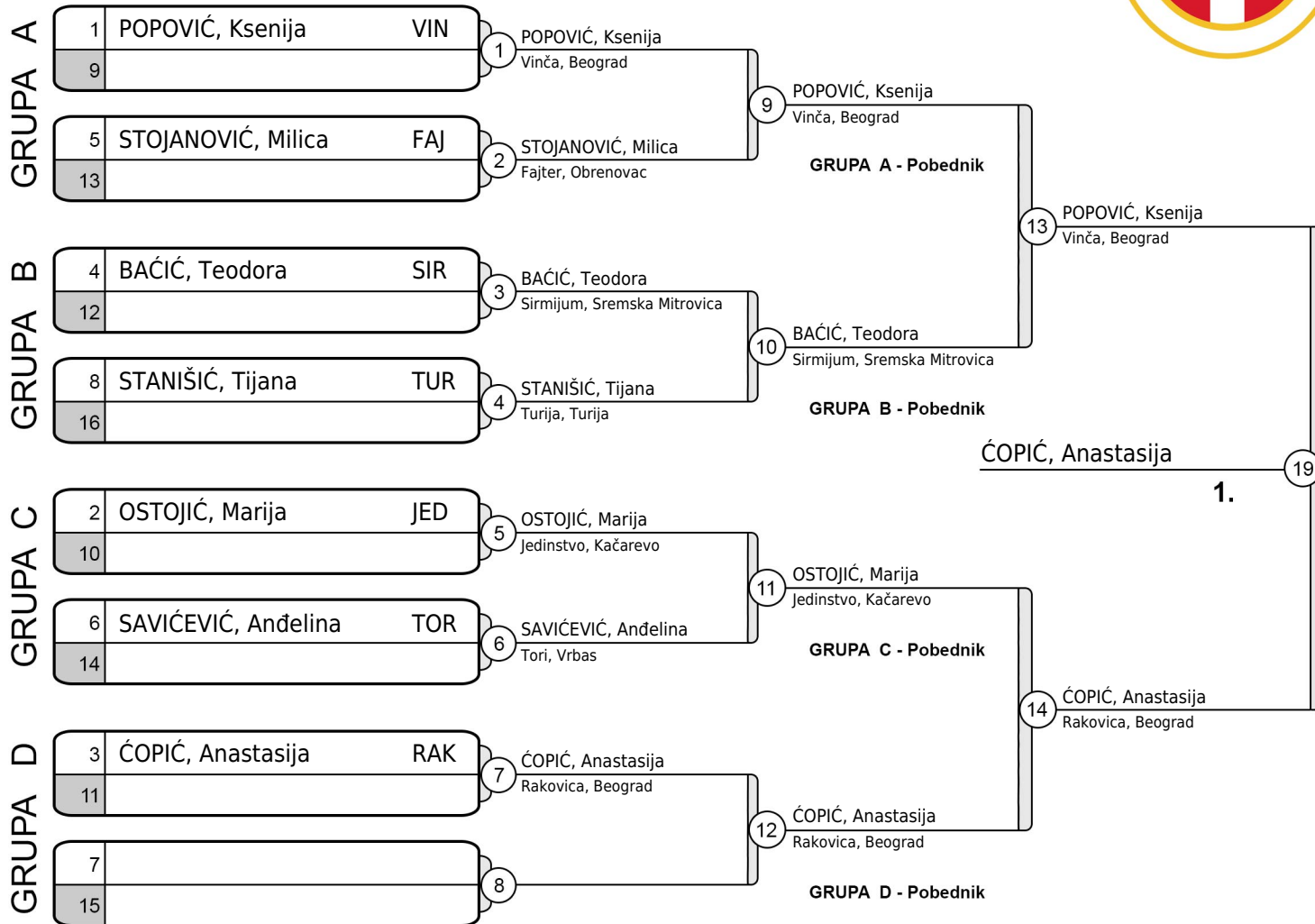

REZULTAT

- | | | |
|----|--------------------|-----|
| 1. | ČOPIĆ, Anastasija | RAK |
| 2. | POPOVIĆ, Ksenija | VIN |
| 3. | BAČIĆ, Teodora | SIR |
| 3. | OSTOJIC, Marija | JED |
| 5. | STOJANOVIĆ, Milica | FAJ |
| 7. | | |
| 7. | | |

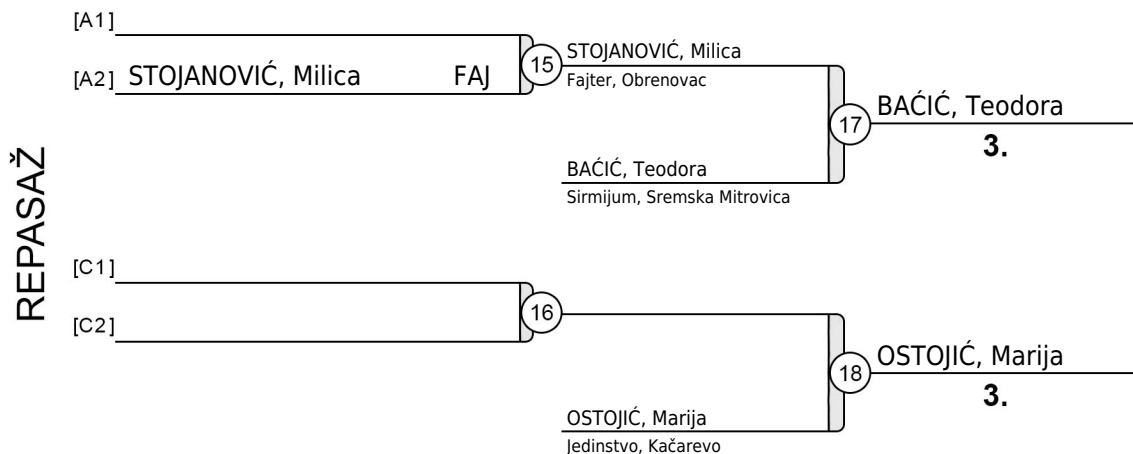

21. Međunarodni džudo turnir TURIJA 2019

Turija, 03.03.2019 - Mlađe pionirke



-48kg

5 takmičarki

| | TAKMIČAR | POBEDNIČKI BODOVI | | | | | POBEDA | BODOVA | MESTO |
|---|---|-------------------|-----|-----|-----|---|--------|--------|-------|
| | | 1 | 2 | 3 | 4 | 5 | | | |
| 1 | BEKVALAC, Duška Jugović, Kać | | 100 | 0 | 0 | 0 | 1 | 100 | 5 |
| 2 | IVANOVIĆ, Ivona Vinča, Beograd | 0 | | 100 | 100 | 0 | 2 | 200 | 3 |
| 3 | ĐUROVIĆ, Helena Jedinstvo, Kačarevo | 100 | 0 | | 0 | 0 | 1 | 100 | 3 |
| 4 | FRENTIU, Raluca SENTOKI, Temeswar | 100 | 0 | 100 | | 0 | 2 | 200 | 2 |
| 5 | SOARE, Alexia MAKO RYU - DESANT, Bucharest | 100 | 100 | 100 | 100 | | 4 | 400 | 1 |

Bodovi: Ippon 100 / Wazaari 10 / Kazna 0.5

Redosled borbi: 1 - 2, 3 - 4 / 1 - 5, 2 - 3 / 4 - 5, 1 - 3 / 2 - 4, 3 - 5 / 1 - 4, 2 - 5

| BORBE | TAKMIČAR | BODOVA | BODOVA | TAKMIČAR | VREME |
|-------|--|------------|------------|---|-------|
| 1 - 2 | BEKVALAC, Duška Jugović, Kać | 100 | 0 | IVANOVIĆ, Ivona Vinča, Beograd | 1:39 |
| 3 - 4 | ĐUROVIĆ, Helena Jedinstvo, Kačarevo | 0 | 100 | FRENTIU, Raluca SENTOKI, Temeswar | 0:37 |
| 1 - 5 | BEKVALAC, Duška Jugović, Kać | 0 | 100 | SOARE, Alexia MAKO RYU - DESANT, Bucharest | 4:29 |
| 2 - 3 | IVANOVIĆ, Ivona Vinča, Beograd | 100 | 0 | ĐUROVIĆ, Helena Jedinstvo, Kačarevo | 0:29 |
| 4 - 5 | FRENTIU, Raluca SENTOKI, Temeswar | 0 | 100 | SOARE, Alexia MAKO RYU - DESANT, Bucharest | 0:21 |
| 1 - 3 | BEKVALAC, Duška Jugović, Kać | 0 | 100 | ĐUROVIĆ, Helena Jedinstvo, Kačarevo | 0:00 |
| 2 - 4 | IVANOVIĆ, Ivona Vinča, Beograd | 100 | 0 | FRENTIU, Raluca SENTOKI, Temeswar | 0:30 |
| 3 - 5 | ĐUROVIĆ, Helena Jedinstvo, Kačarevo | 0 | 100 | SOARE, Alexia MAKO RYU - DESANT, Bucharest | 0:12 |
| 1 - 4 | BEKVALAC, Duška Jugović, Kać | 0 | 100 | FRENTIU, Raluca SENTOKI, Temeswar | 0:00 |
| 2 - 5 | IVANOVIĆ, Ivona Vinča, Beograd | 0 | 100 | SOARE, Alexia MAKO RYU - DESANT, Bucharest | 0:36 |

REZULTAT

| | |
|--------------------|-----|
| 1. SOARE, Alexia | MRD |
| 2. FRENTIU, Raluca | SEN |
| 3. IVANOVIĆ, Ivona | VIN |
| 3. ĐUROVIĆ, Helena | JED |
| 5. BEKVALAC, Duška | JUG |

21. Međunarodni džudo turnir TUR IJA 2019

Turija, 03.03.2019 - Mlađe pionirke

-52kg

4 takmičarki



| | TAKMIČAR | POBEDNIČKI BODOVI | | | | POBEDA | BODOVA | MESTO |
|---|---|-------------------|-----|-----|-----|--------|--------|-------|
| | | 1 | 2 | 3 | 4 | | | |
| 1 | STOJKOVIĆ, Anastasija Kučevo, Kučevo | | 100 | 100 | 100 | 3 | 300 | 1 |
| 2 | GADŽIĆ, Nataša Turija, Turija | 0 | | 100 | 100 | 2 | 200 | 3 |
| 3 | SEKULOVIĆ, Milena Dinamo, Pančevo | 0 | 0 | | 100 | 1 | 100 | 2 |
| 4 | PANTELIĆ, Ivana Vojvodina, Novi Sad | 0 | 0 | 0 | | 0 | 0 | |

Bodovi: Ippon 100 / Wazaari 10 / Kazna 0.5

Redosled borbi: 1 - 2, 3 - 4 / 1 - 3, 2 - 4 / 1 - 4, 2 - 3

| BORBE | TAKMIČAR | BODOVA | BODOVA | TAKMIČAR | VREME |
|-------|---|------------|----------|--|-------|
| 1 - 2 | STOJKOVIĆ, Anastasija Kučevo, Kučevo | 100 | 0 | GADŽIĆ, Nataša Turija, Turija | 1:02 |
| 3 - 4 | SEKULOVIĆ, Milena Dinamo, Pančevo | 100 | 0 | PANTELIĆ, Ivana Vojvodina, Novi Sad | 0:07 |
| 1 - 3 | STOJKOVIĆ, Anastasija Kučevo, Kučevo | 100 | 0 | SEKULOVIĆ, Milena Dinamo, Pančevo | 0:08 |
| 2 - 4 | GADŽIĆ, Nataša Turija, Turija | 100 | 0 | PANTELIĆ, Ivana Vojvodina, Novi Sad | 0:05 |
| 1 - 4 | STOJKOVIĆ, Anastasija Kučevo, Kučevo | 100 | 0 | PANTELIĆ, Ivana Vojvodina, Novi Sad | 0:07 |
| 2 - 3 | GADŽIĆ, Nataša Turija, Turija | 100 | 0 | SEKULOVIĆ, Milena Dinamo, Pančevo | 0:37 |

REZULTAT

1. STOJKOVIĆ, Anastasija KUC
2. SEKULOVIĆ, Milena DIN
3. GADŽIĆ, Nataša TUR
3. GADŽIĆ, Nataša TUR

21. Međunarodni džudo turnir TURIJA 2019

Turija, 03.03.2019 - Mlađe pionirke

-56kg

2 takmičarke



| BORBE | TAKMIČAR | BODOVA | BODOVA | TAKMIČAR | VREME |
|------------------|---|--------|--------|---|-------|
| 1 - 2 | JEVTOVIĆ, Stanislava Džuns, Novi Sad | 100 | 0 | NIŠAVIĆ, Andrea Turija, Turija | 0:05 |
| 1 - 2 | JEVTOVIĆ, Stanislava Džuns, Novi Sad | 100 | 0 | NIŠAVIĆ, Andrea Turija, Turija | 1:49 |
| 1 - 2 | JEVTOVIĆ, Stanislava Džuns, Novi Sad | | | NIŠAVIĆ, Andrea Turija, Turija | |

Bodovi: Ippon 100 / Wazaari 10 / Kazna 0.5

Kriterijum za određivanje pobednika: Dve pobeđe

REZULTAT

1. JEVTOVIĆ, Stanislava DZU
2. NIŠAVIĆ, Andrea TUR

21. Međunarodni džudo turnir TURIJJA 2019

Turija, 03.03.2019 - Mlađe pionirke

+56kg

3 takmičarke



| | TAKMIČAR | POBEDNIČKI BODOVI | | | POBEDA | BODOVA | MESTO |
|---|--|-------------------|---|-----|--------|--------|-------|
| | | 1 | 2 | 3 | | | |
| 1 | ĐUROVIĆ, Milica DIF 021, Novi Sad | | 0 | 0 | 0 | 0 | 3 |
| 2 | SAVIĆ, Valerija Vinča, Beograd | 100 | | 100 | 2 | 200 | 1 |
| 3 | LULEDŽIJA, Marija Srpski Soko, Mali Zvornik | 100 | 0 | | 1 | 100 | 2 |

BODOVI: Ippon 100 / Wazaari 10 / Kazna 0.5

Redosled borbi: 1 - 2 / 1 - 3 / 2 - 3

| BORBE | TAKMIČAR | BODOVA | BODOVA | TAKMIČAR | VREME |
|-------|--------------------------------------|--------|--------|--|-------|
| 1 - 2 | ĐUROVIĆ, Milica DIF 021, Novi Sad | 0 | 100 | SAVIĆ, Valerija Vinča, Beograd | 0:49 |
| 1 - 3 | ĐUROVIĆ, Milica DIF 021, Novi Sad | 0 | 100 | LULEDŽIJA, Marija Srpski Soko, Mali Zvornik | 2:46 |
| 2 - 3 | SAVIĆ, Valerija Vinča, Beograd | 100 | 0 | LULEDŽIJA, Marija Srpski Soko, Mali Zvornik | 1:57 |

REZULTAT

1. SAVIĆ, Valerija VIN
2. LULEDŽIJA, Marija SRS
3. ĐUROVIĆ, Milica 021

21. Međunarodni džudo turnir TURIJA 2019

Turija, 03.03.2019 - Stariji pioniri

-34kg

2 takmičara



| BORBE | TAKMIČAR | BODOVA | BODOVA | TAKMIČAR | VREME |
|------------------|---|--------|--------|---|-------|
| 1 - 2 | BARANJ, Tivadar Obrenovac, Obrenovac | 0 | 100 | TROBONJAČA, Vukašin Turija, Turija | 1:21 |
| 1 - 2 | BARANJ, Tivadar Obrenovac, Obrenovac | 0 | 100 | TROBONJAČA, Vukašin Turija, Turija | 0:50 |
| 1 - 2 | BARANJ, Tivadar Obrenovac, Obrenovac | | | TROBONJAČA, Vukašin Turija, Turija | |

Bodovi: Ippon 100 / Wazaari 10 / Kazna 0.5

Kriterijum za određivanje pobednika: Dve pobeđe

REZULTAT

1. TROBONJAČA, Vukašin TUR
2. BARANJ, Tivadar OBR

21. Međunarodni džudo turnir TURIJIA 2019

Turija, 03.03.2019 - Stariji pioniri



-38kg

9 takmičara

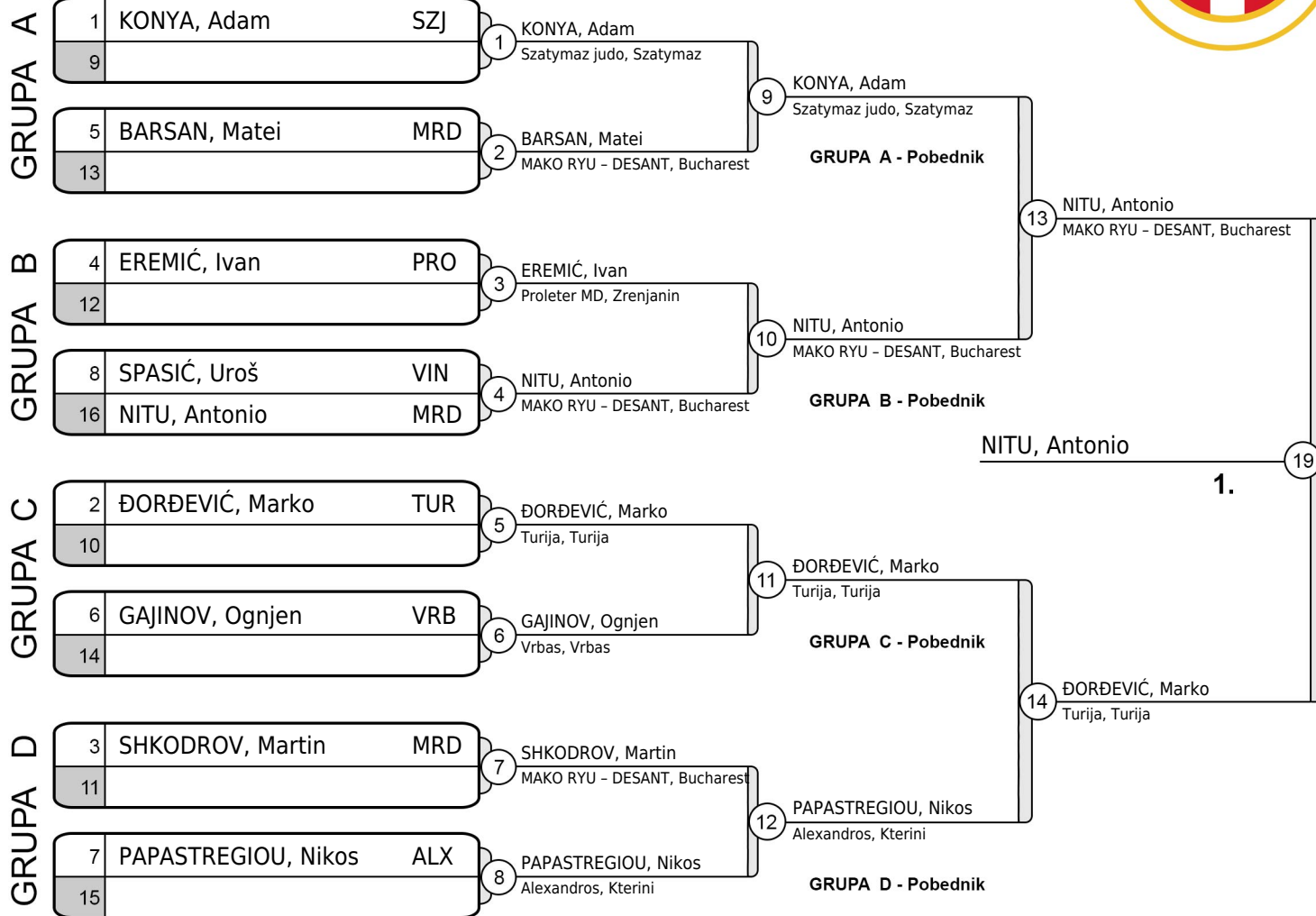

REZULTAT

| | | |
|----|---------------------|-----|
| 1. | NITU, Antonio | MRD |
| 2. | ĐORĐEVIĆ, Marko | TUR |
| 3. | EREMIĆ, Ivan | PRO |
| 3. | PAPASTREGIOU, Nikos | ALX |
| 5. | KONYA, Adam | SZJ |
| 5. | GAJINOV, Ognjen | VRB |
| 7. | SPASIĆ, Uroš | VIN |
| 7. | | |

REPASAŽ

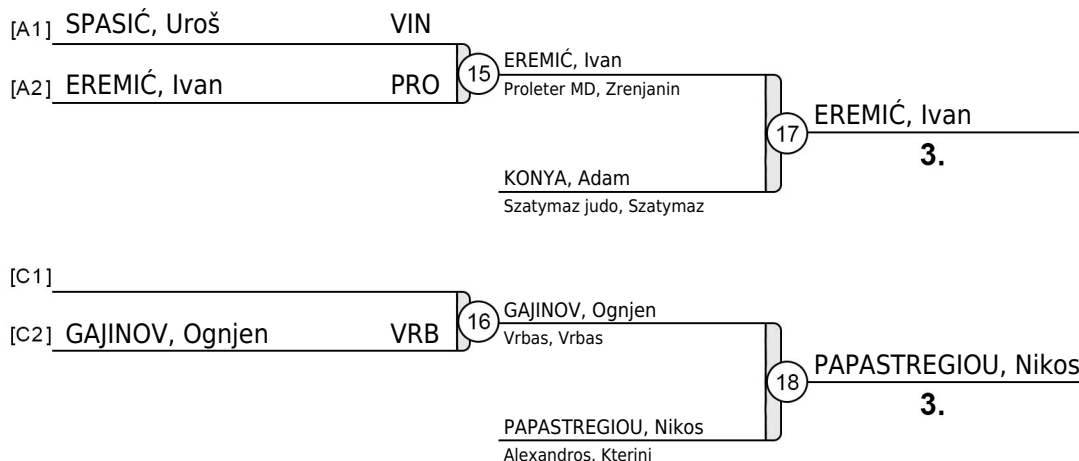

21. Međunarodni džudo turnir TURIJA 2019

Turija, 03.03.2019 - Stariji pioniri

-42kg

4 takmičara

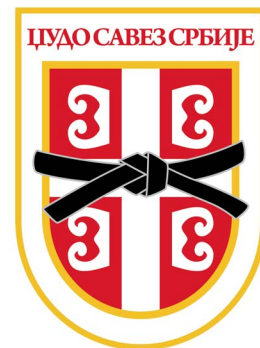

| | TAKMIČAR | POBEDNIČKI BODOVI | | | | POBEDA | BODOVA | MESTO |
|---|--|-------------------|-----|-----|-----|--------|--------|-------|
| | | 1 | 2 | 3 | 4 | | | |
| 1 | MARKOVIĆ, Milan Obrenovac, Obrenovac | | 100 | 100 | 100 | 3 | 300 | 1 |
| 2 | ĐURĐEVIĆ, Vukašin Fajter, Obrenovac | 0 | | 0 | 0 | 0 | 0 | 3 |
| 3 | OSTOJIĆ, Luka TSK Temerin, Temerin | 0 | 100 | | 0 | 1 | 100 | 3 |
| 4 | JOVANOVIĆ, Stefan Žandarmerija, Beograd | 100 | 100 | 0 | | 2 | 200 | 2 |

Bodovi: Ippon 100 / Wazaari 10 / Kazna 0.5

Redosled borbi: 1 - 2, 3 - 4 / 1 - 3, 2 - 4 / 1 - 4, 2 - 3

| BORBE | TAKMIČAR | BODOVA | BODOVA | TAKMIČAR | VREME |
|-------|---|------------|------------|--|-------|
| 1 - 2 | MARKOVIĆ, Milan Obrenovac, Obrenovac | 100 | 0 | ĐURĐEVIĆ, Vukašin Fajter, Obrenovac | 3:09 |
| 3 - 4 | OSTOJIĆ, Luka TSK Temerin, Temerin | 0 | 100 | JOVANOVIĆ, Stefan Žandarmerija, Beograd | 0:57 |
| 1 - 3 | MARKOVIĆ, Milan Obrenovac, Obrenovac | 100 | 0 | OSTOJIĆ, Luka TSK Temerin, Temerin | 1:24 |
| 2 - 4 | ĐURĐEVIĆ, Vukašin Fajter, Obrenovac | 0 | 100 | JOVANOVIĆ, Stefan Žandarmerija, Beograd | 0:57 |
| 1 - 4 | MARKOVIĆ, Milan Obrenovac, Obrenovac | 100 | 0 | JOVANOVIĆ, Stefan Žandarmerija, Beograd | 2:45 |
| 2 - 3 | ĐURĐEVIĆ, Vukašin Fajter, Obrenovac | 0 | 100 | OSTOJIĆ, Luka TSK Temerin, Temerin | 1:32 |

REZULTAT

| | |
|----------------------|-----|
| 1. MARKOVIĆ, Milan | OBR |
| 2. JOVANOVIĆ, Stefan | ŽAN |
| 3. OSTOJIĆ, Luka | TSK |
| 3. ĐURĐEVIĆ, Vukašin | FAJ |

21. Međunarodni džudo turnir TURIJA 2019

Turija, 03.03.2019 - Stariji pioniri



-46kg

17 takmičara

GRUPA A

| | | |
|----|------------------------|-----|
| 1 | PETROVIĆ, Pavle | RAK |
| 17 | | |
| 9 | TATALOVIĆ, Nikola | SPA |
| 25 | | |
| 5 | MIKIN, Ilija | PRO |
| 21 | | |
| 13 | VUKADINOVIĆ, Branislav | ISH |
| 29 | | |

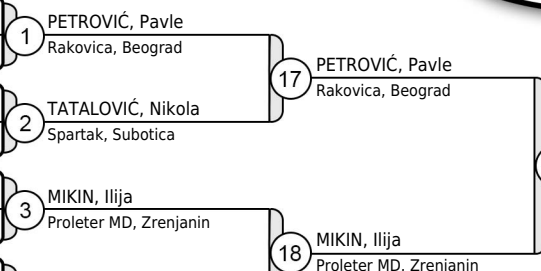

GRUPA B

| | | |
|----|----------------------|-----|
| 4 | VUCKOVIĆ, Andrej | ŽAN |
| 20 | | |
| 12 | VILCU, Sabin | MRD |
| 28 | | |
| 8 | STOJANOVIĆ, Miroslav | MLA |
| 24 | | |
| 16 | VOLAKOV, Danijel | LOK |
| 32 | | |

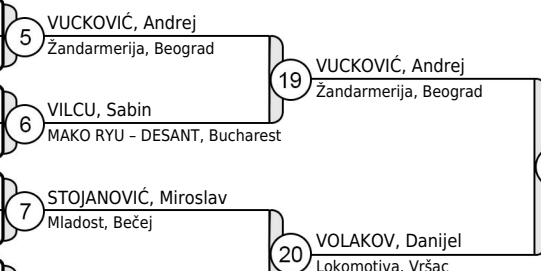

GRUPA C

| | | |
|----|--------------------|-----|
| 2 | NOVAKOVIĆ, Nikola | BAČ |
| 18 | | |
| 10 | BURAZIN, Leo | SPA |
| 26 | BRANKOVIĆ, Luka | CZB |
| 6 | PALIĆ, Nataniyel | ZMA |
| 22 | | |
| 14 | VIŠEKRUNA, Andrija | TSK |
| 30 | | |

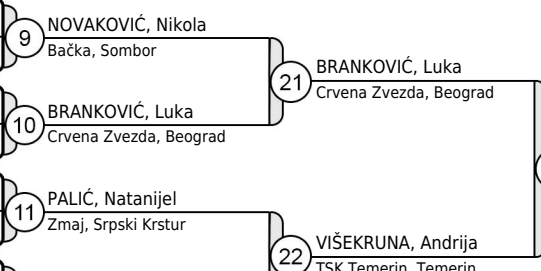

GRUPA D

| | | |
|----|--------------------|-----|
| 3 | ADI, Georgiu | SEN |
| 19 | | |
| 11 | PETROVIĆ, Vladimir | CEM |
| 27 | | |
| 7 | IONESKU, Darius | MRD |
| 23 | | |
| 15 | OŽEGOVIĆ, Vuk | LOK |
| 31 | | |

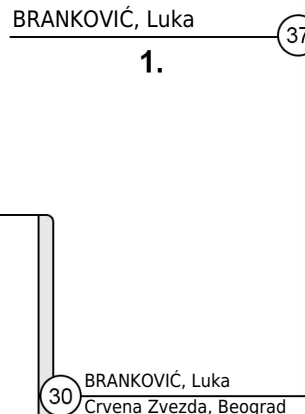
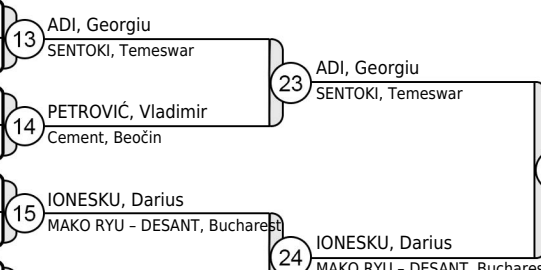

| REZULTAT | |
|----------|------------------------|
| 1. | BRANKOVIĆ, Luka CZB |
| 2. | PETROVIĆ, Pavle RAK |
| 3. | MIKIN, Ilija PRO |
| 3. | ADI, Georgiu SEN |
| 5. | VOLAKOV, Danijel LOK |
| 7. | TATALOVIĆ, Nikola SPA |
| 7. | VIŠEKRUNA, Andrija TSK |

REPASAŽ

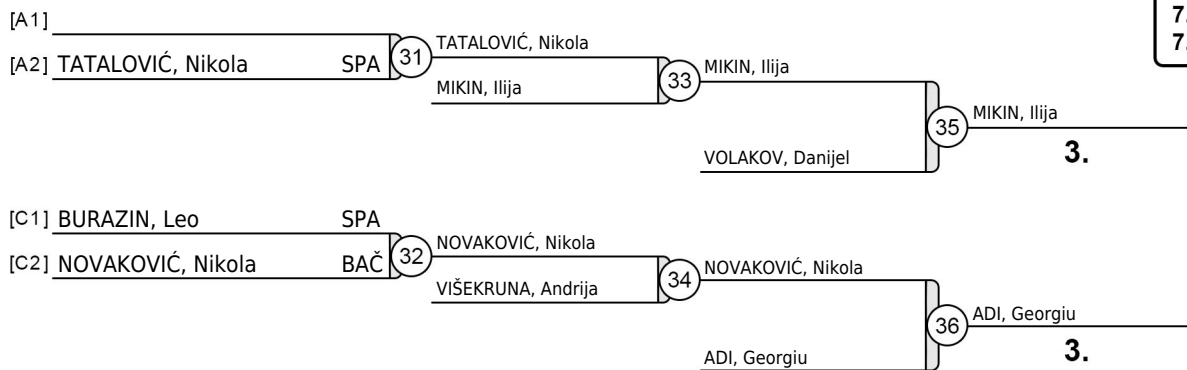

21. Međunarodni džudo turnir TURIGA 2019

Turija, 03.03.2019 - Stariji pioniri

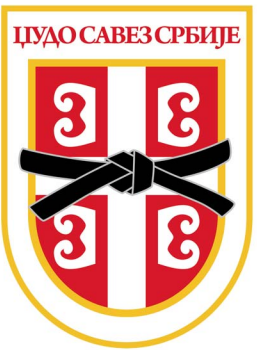

-50kg

16 takmičara

GRUPA A

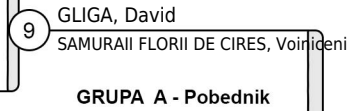
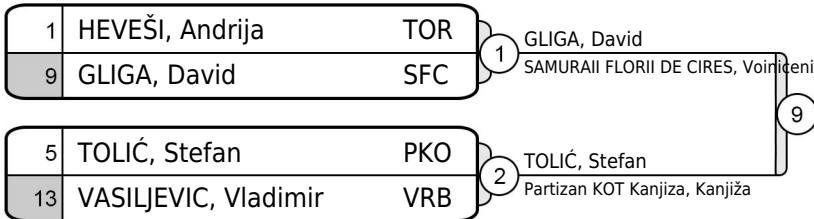

GRUPA A - Pobjednik

GRUPA B

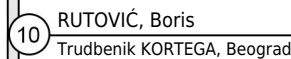
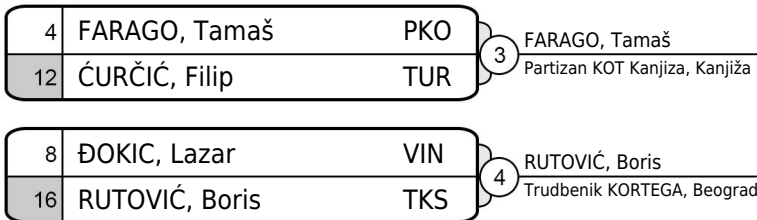

GRUPA B - Pobjednik

GRUPA C

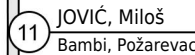
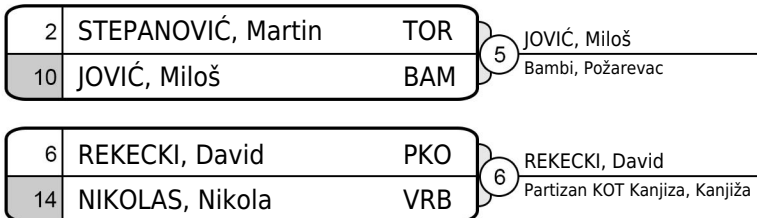

GRUPA C - Pobjednik

GRUPA D

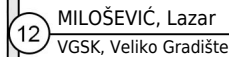
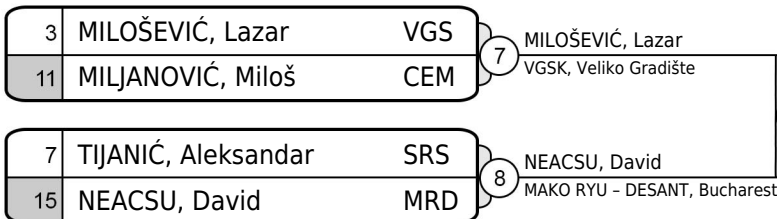

GRUPA D - Pobjednik

MILOŠEVIĆ, Lazar

1.

14 MILOŠEVIĆ, Lazar
VGSK, Veliko Gradište

REZULTAT

| | | |
|----|-------------------|-----|
| 1. | MILOŠEVIĆ, Lazar | VGS |
| 2. | GLIGA, David | SFC |
| 3. | RUTOVIĆ, Boris | TKS |
| 3. | MILJANOVIĆ, Miloš | CEM |
| 5. | TOLIĆ, Stefan | PKO |
| 5. | JOVIĆ, Miloš | BAM |
| 7. | HEVEŠI, Andrija | TOR |
| 7. | NEACSU, David | MRD |

REPASAŽ

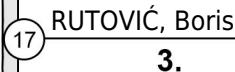
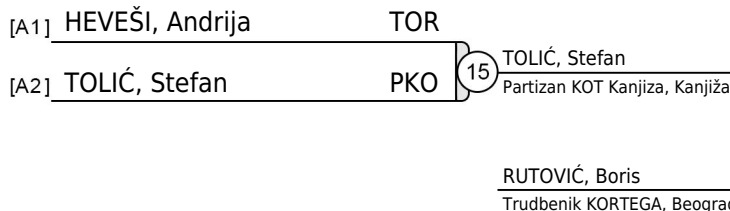

3.

RUTOVIĆ, Boris
Trudbenik KORTEGA, Beograd

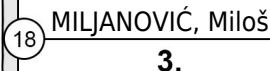
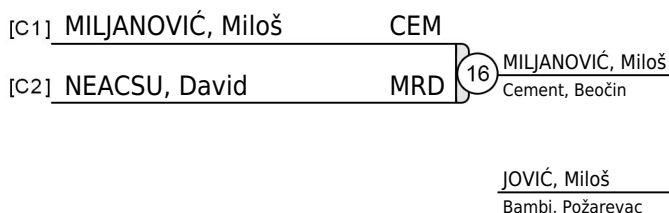

3.

JOVIĆ, Miloš
Bambi, Požarevac

21. Međunarodni džudo turnir TURIJA 2019

Turija, 03.03.2019 - Stariji pioniri

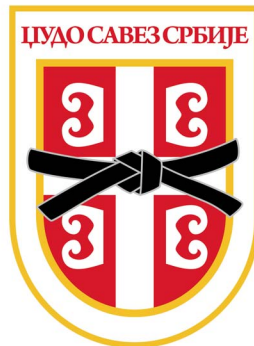

-55kg

18 takmičara

GRUPA A

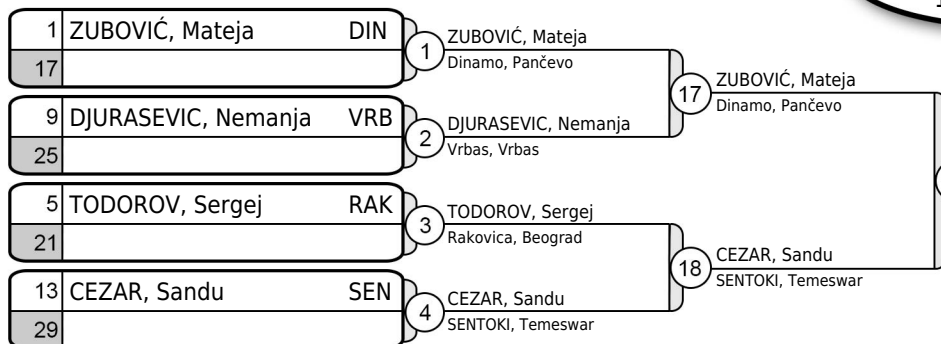

GRUPA A - Pobjednik

GRUPA B

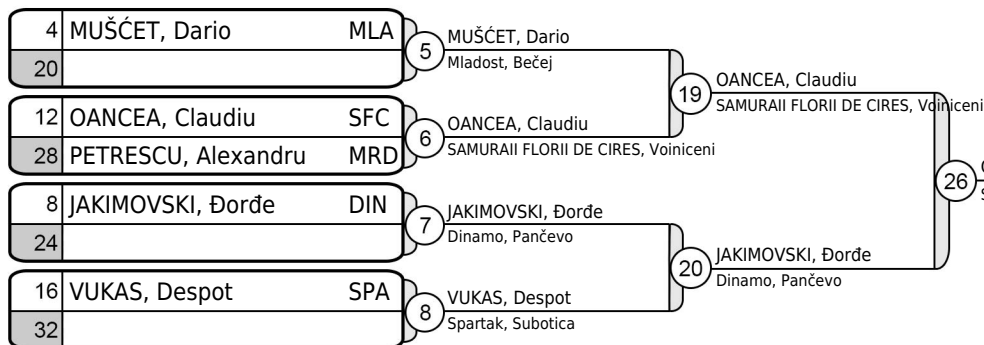

GRUPA B - Pobjednik

GRUPA C

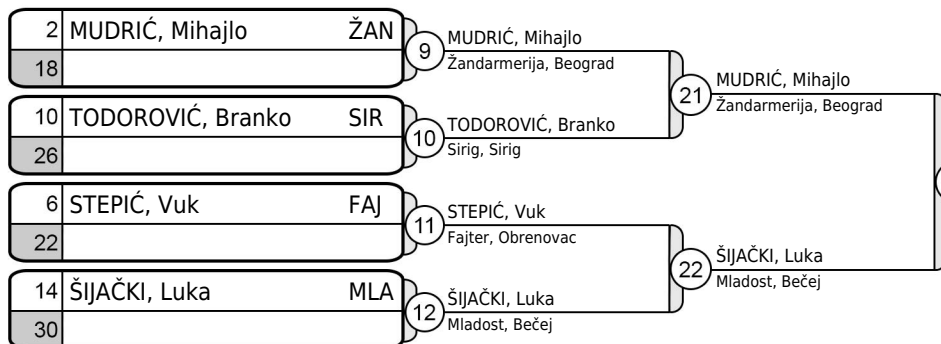

GRUPA C - Pobjednik

GRUPA D

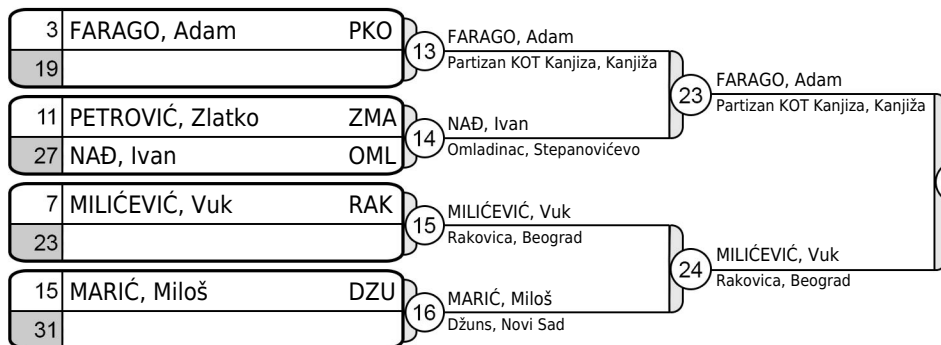

GRUPA D - Pobjednik

OANCEA, Claudiu

1.

MILIĆEVIĆ, Vuk
Rakovica, Beograd

REZULTAT

- | | | |
|----|---------------------|-----|
| 1. | OANCEA, Claudiu | SFC |
| 2. | MILIĆEVIĆ, Vuk | RAK |
| 3. | PETRESCU, Alexandru | MRD |
| 3. | FARAGO, Adam | PKO |
| 5. | CEZAR, Sandu | SEN |
| 5. | MUDRIĆ, Mihajlo | ŽAN |
| 7. | JAKIMOVSKI, Đorđe | DIN |
| 7. | MARIĆ, Miloš | DZU |

REPASAŽ

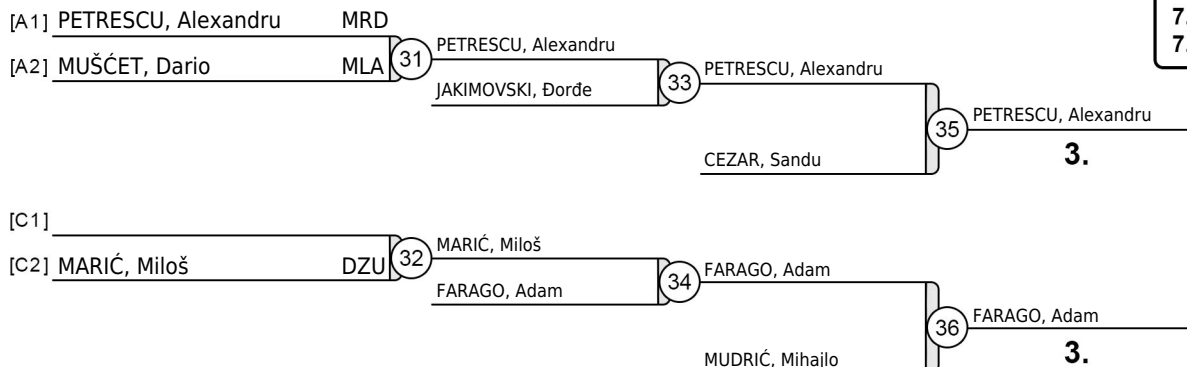

3.

3.

21. Međunarodni džudo turnir TURIJIA 2019

Turija, 03.03.2019 - Stariji pioniri



-60kg

10 takmičara

GRUPA A

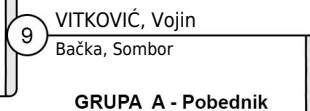
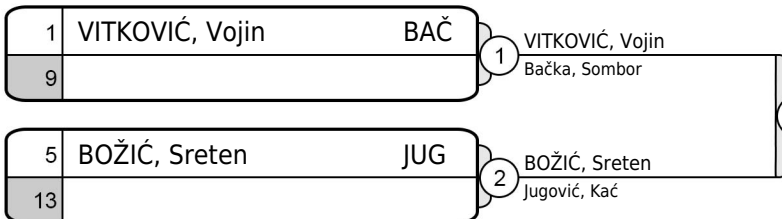

GRUPA B

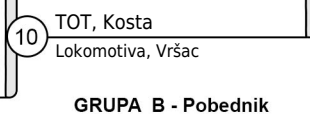
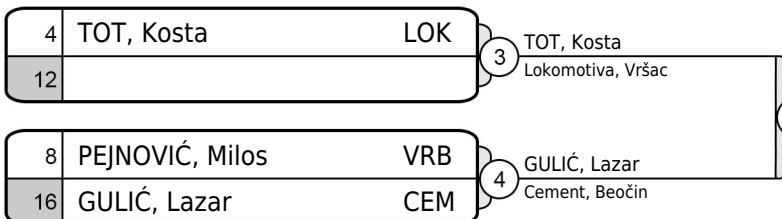

GRUPA C

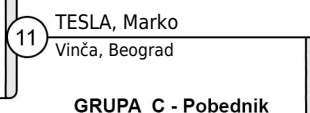
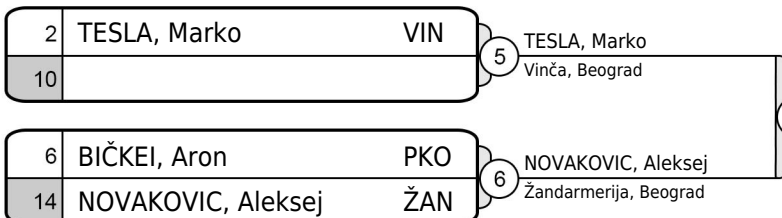

GRUPA D

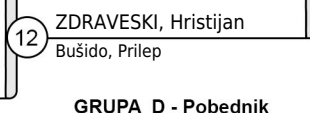
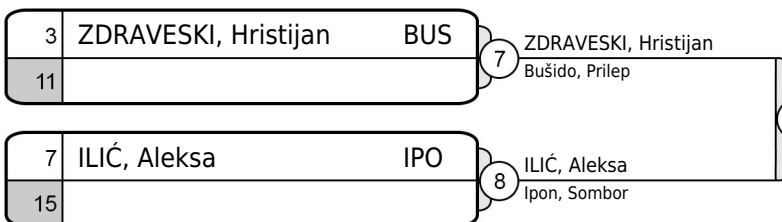

VITKOVIĆ, Vojin

1.

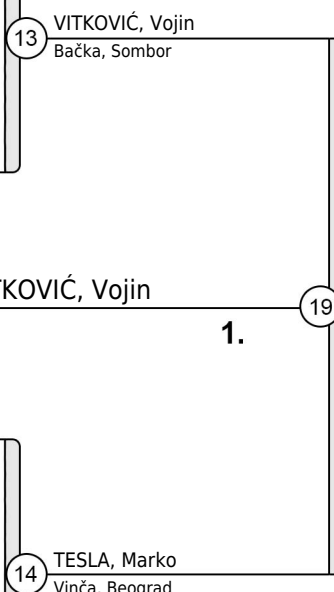

REZULTAT

- | | | |
|----|----------------------|-----|
| 1. | VITKOVIĆ, Vojin | BAČ |
| 2. | TESLA, Marko | VIN |
| 3. | BOŽIĆ, Sreten | JUG |
| 3. | ZDRAVESKI, Hristijan | BUS |
| 5. | TOT, Kosta | LOK |
| 5. | NOVAKOVIC, Aleksej | ŽAN |
| 7. | | |
| 7. | | |

REPASAŽ

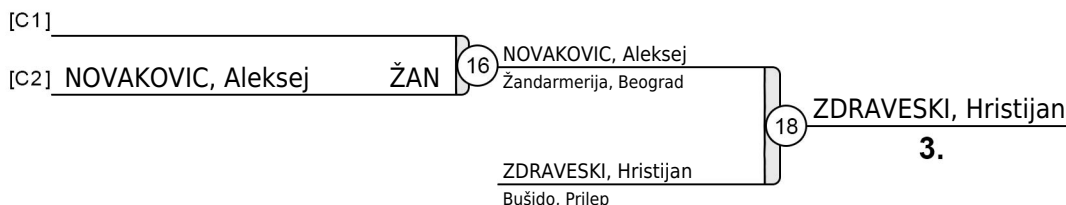

21. Međunarodni džudo turnir TURIJA 2019

Turija, 03.03.2019 - Stariji pioniri

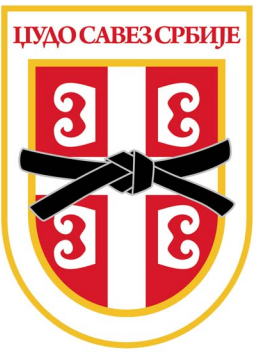

-66kg

13 takmičara

GRUPA A

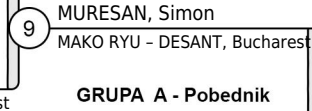
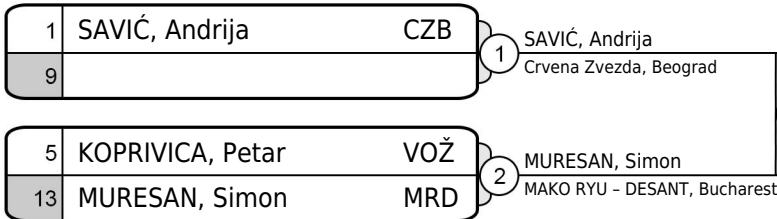

GRUPA B

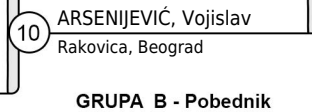
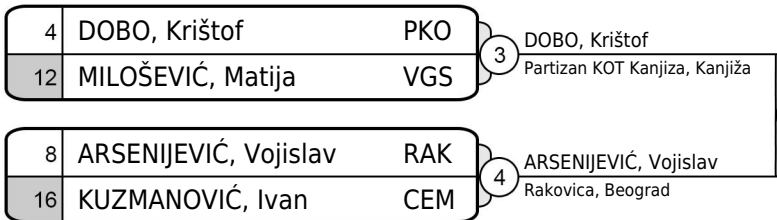

GRUPA C

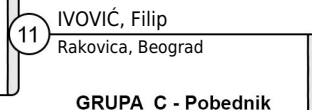
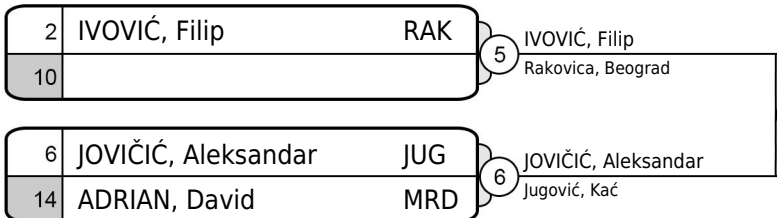

GRUPA D

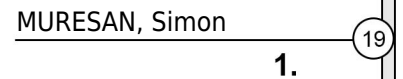
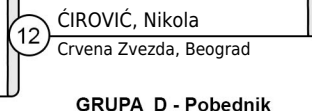
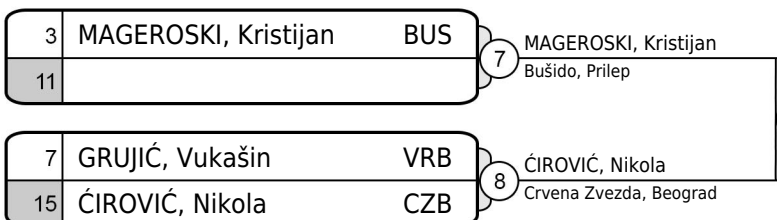

REPASAŽ

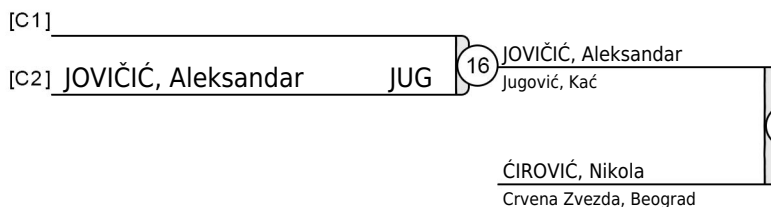
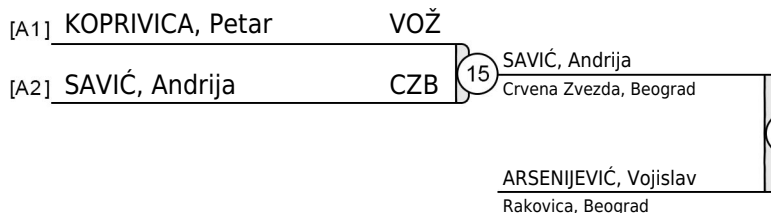

REZULTAT

- | | | |
|----|-----------------------|-----|
| 1. | MURESAN, Simon | MRD |
| 2. | IVOVIĆ, Filip | RAK |
| 3. | SAVIĆ, Andrija | CZB |
| 4. | ĆIROVIĆ, Nikola | CZB |
| 5. | ARSENIJEVIĆ, Vojislav | RAK |
| 6. | JOVIČIĆ, Aleksandar | JUG |
| 7. | KOPRIVICA, Petar | VOŽ |

21. Međunarodni džudo turnir TURIJIA 2019

Turija, 03.03.2019 - Stariji pioniri



-73kg

7 takmičara

GRUPA A

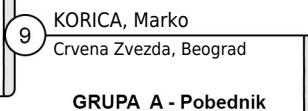
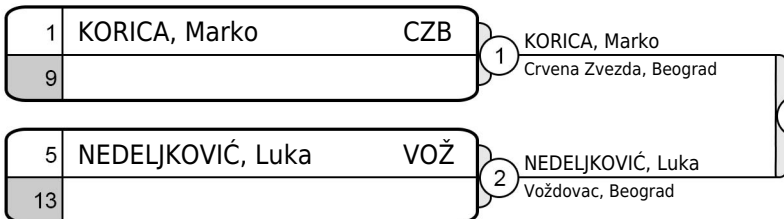

GRUPA B

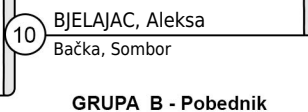
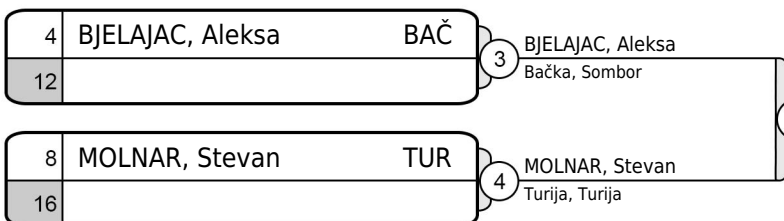

GRUPA C

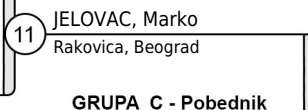
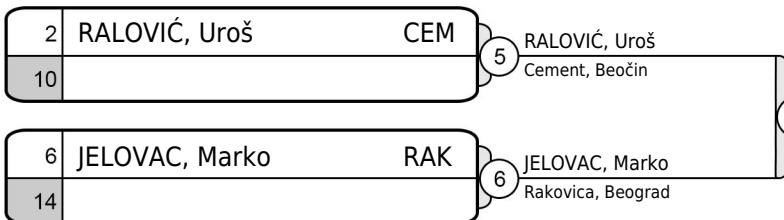

GRUPA D

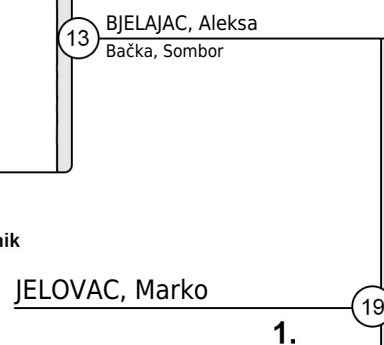
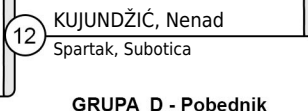
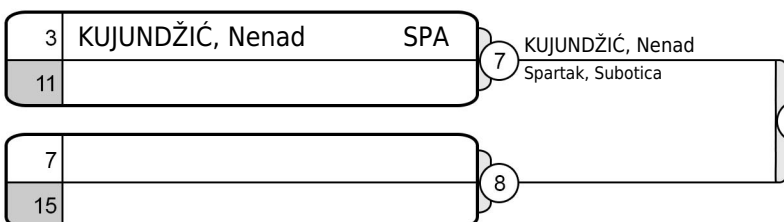

REPASAŽ

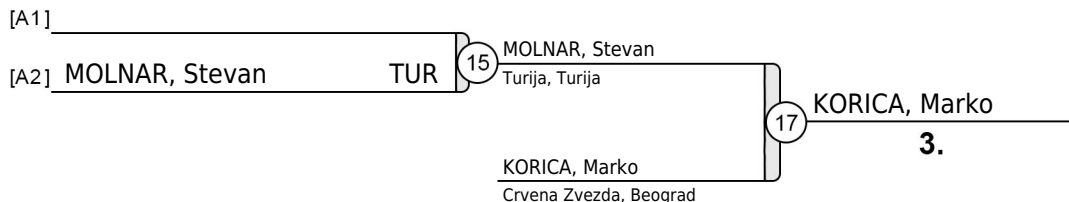

REZULTAT

- | | | |
|----|------------------|-----|
| 1. | JELOVAC, Marko | RAK |
| 2. | BJELAJAC, Aleksa | BAČ |
| 3. | KORICA, Marko | CZB |
| 5. | MOLNAR, Stevan | TUR |
| 5. | KUJUNDŽIĆ, Nenad | SPA |
| 7. | | |
| 7. | | |

21. Međunarodni džudo turnir TURIJA 2019

Turija, 03.03.2019 - Stariji pioniri

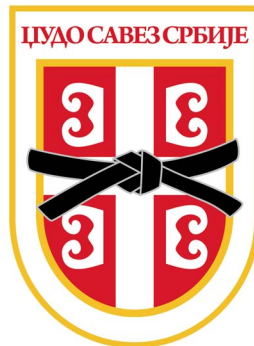

+73kg

9 takmičara

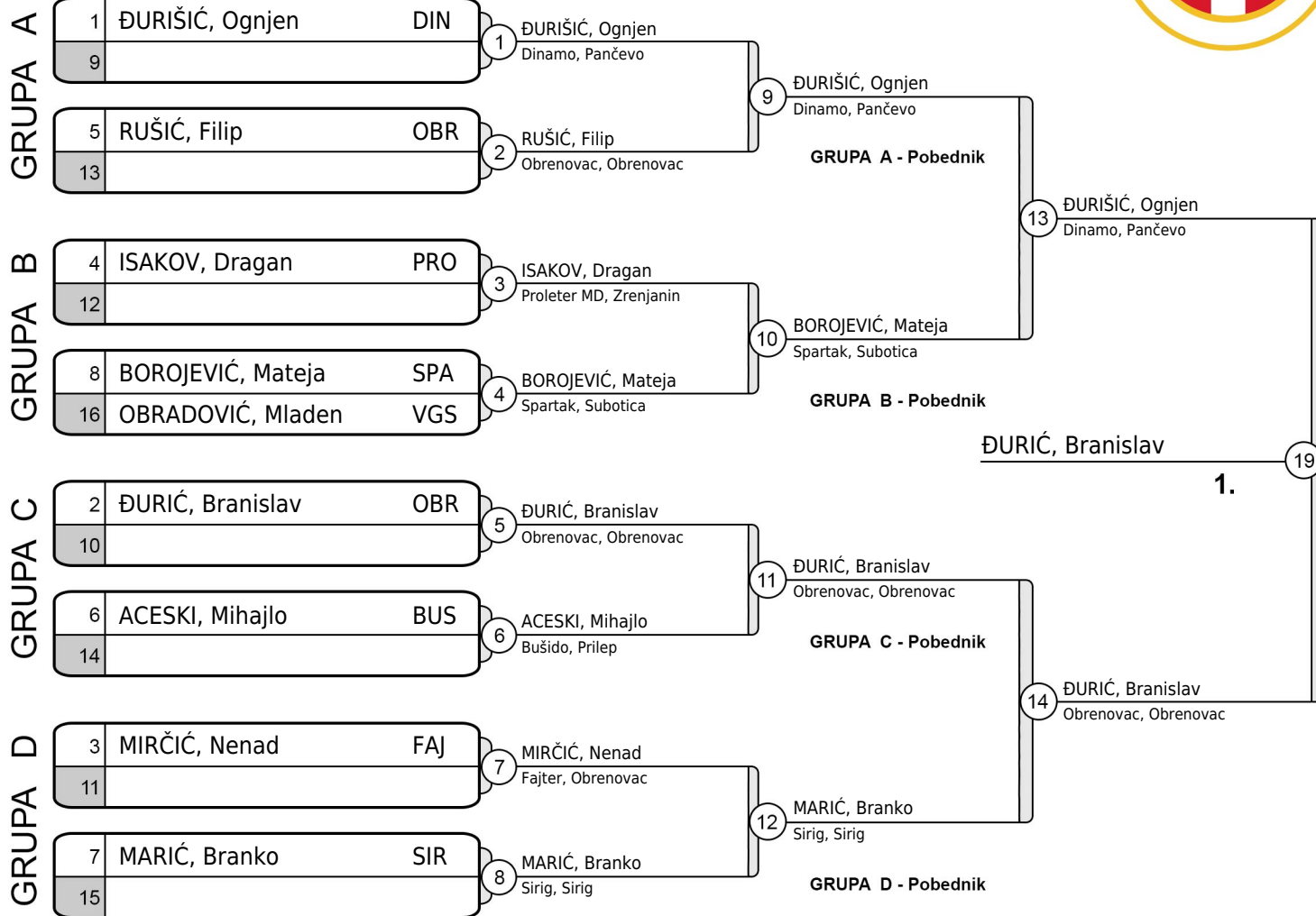

REZULTAT

1. ĐURIĆ, Branislav OBR
2. ĐURIŠIĆ, Ognjen DIN
3. BOROJEVIĆ, Mateja SPA
3. MARIĆ, Branko SIR
5. RUŠIĆ, Filip OBR
5. ACESKI, Mihajlo BUS
- 7.
- 7.

REPASAŽ

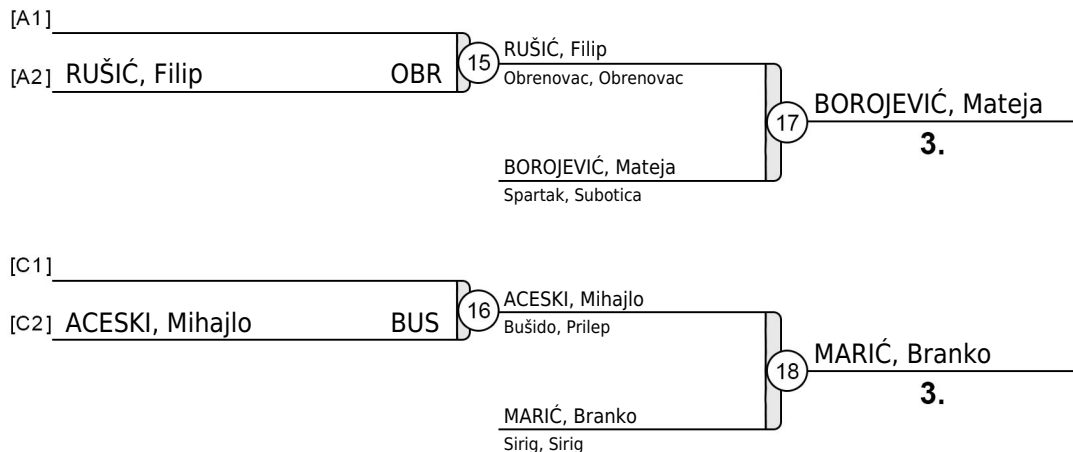

21. Međunarodni džudo turnir TURIJA 2019

Turija, 03.03.2019 - Starije pionirke



-32kg

0 takmičarki

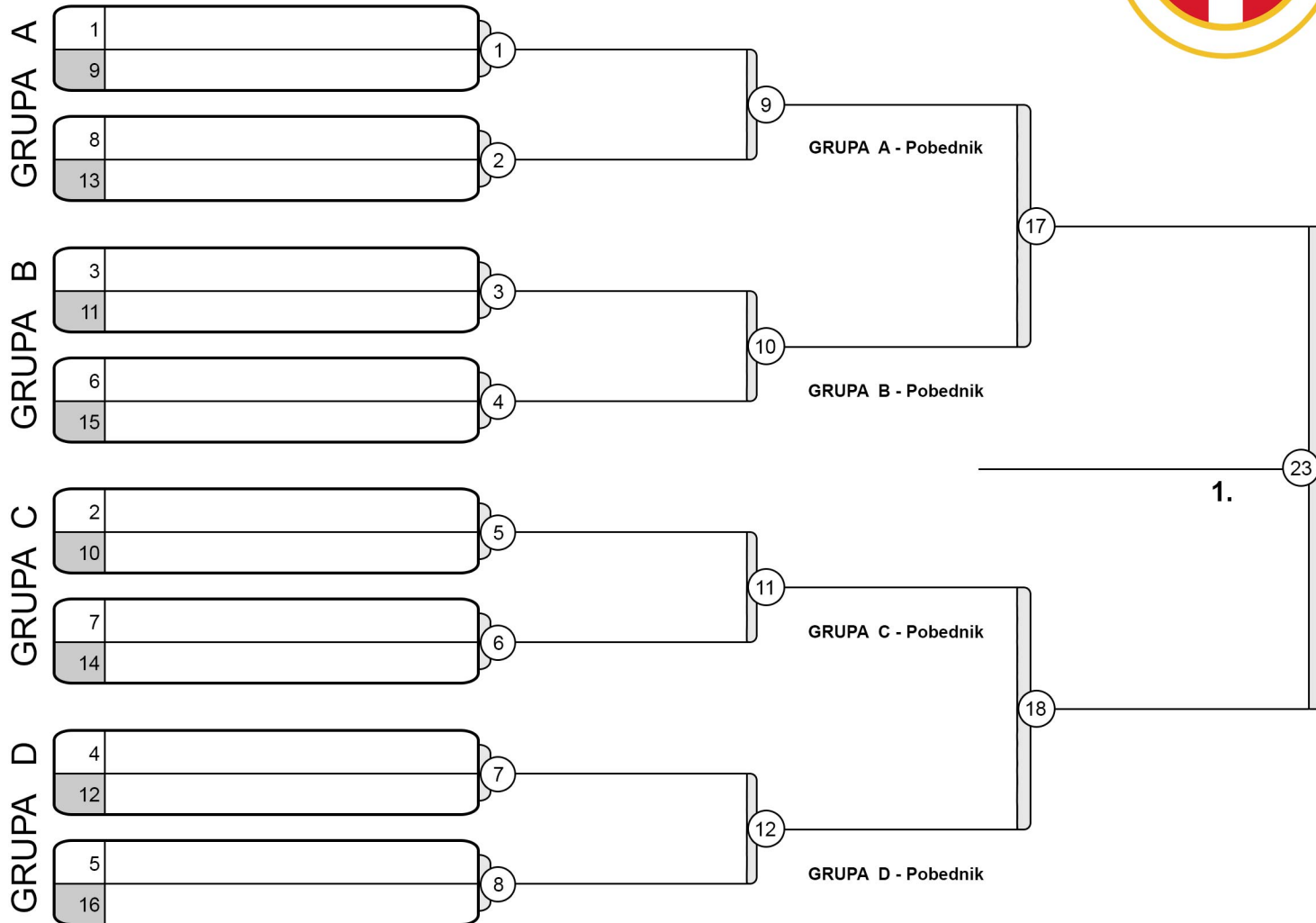

REZULTAT

- 1.
- 2.
- 3.
- 3.
- 5.
- 7.
- 7.

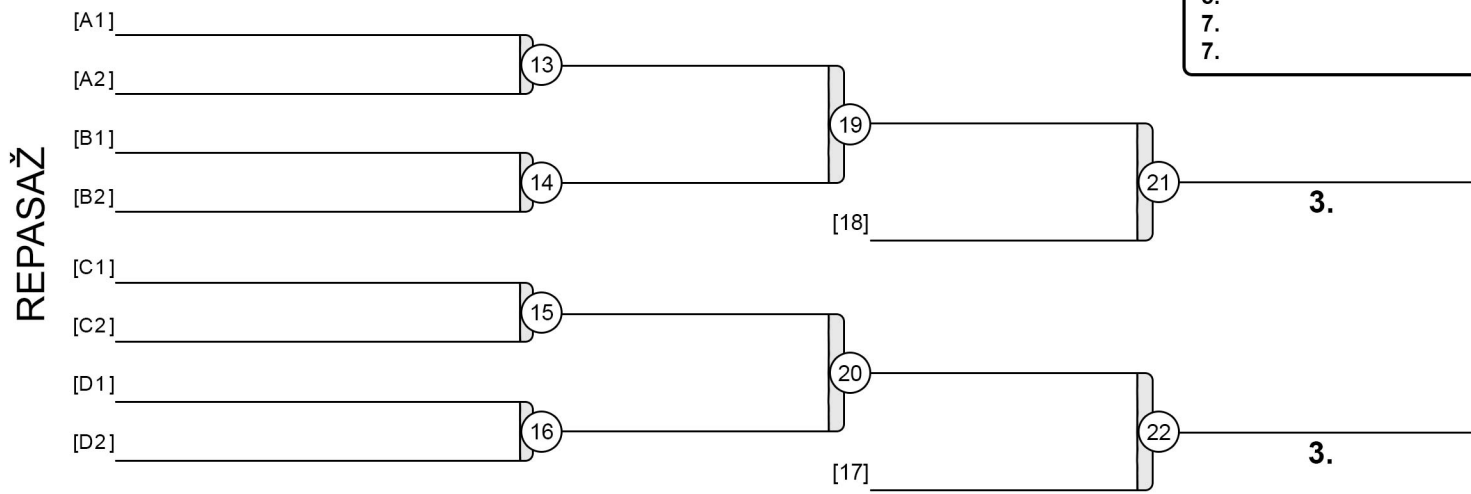

21. Međunarodni džudo turnir TURIJA 2019

Turija, 03.03.2019 - Starije pionirke

-36kg

2 takmičarke



| BORBE | TAKMIČAR | BODOVA | BODOVA | TAKMIČAR | VREME |
|------------------|---|--------|--------|---|-------|
| 1 - 2 | KRTENIĆ, Andrijana Jedinstvo, Kačarevo | 100 | 0 | KOVAČ, Ana Jedinstvo, Kačarevo | 0:37 |
| 1 - 2 | KRTENIĆ, Andrijana Jedinstvo, Kačarevo | 100 | 0 | KOVAČ, Ana Jedinstvo, Kačarevo | 2:29 |
| 1 - 2 | KRTENIĆ, Andrijana Jedinstvo, Kačarevo | | | KOVAČ, Ana Jedinstvo, Kačarevo | |

Bodovi: Ippon 100 / Wazaari 10 / Kazna 0.5

Kriterijum za određivanje pobednika: Dve pobeđe

REZULTAT

1. KRTENIĆ, Andrijana JED
2. KOVAČ, Ana JED

21. Međunarodni džudo turnir TURIJA 2019

Turija, 03.03.2019 - Starije pionirke



-40kg

5 takmičarki

| | TAKMIČAR | POBEDNIČKI BODOVI | | | | | POBEDA | BODOVA | MESTO |
|---|--|-------------------|----|-----|-----|---|--------|--------|-------|
| | | 1 | 2 | 3 | 4 | 5 | | | |
| 1 | LUKIĆ, Sara Obrenovac, Obrenovac | | 0 | 0 | 0 | 0 | 0 | 0 | 5 |
| 2 | STOJANOVSKI, Jelena Dinamo, Pančevo | 100 | | 100 | 100 | 0 | 3 | 300 | 2 |
| 3 | MALINOSKA, Elena Bušido, Prilep | 100 | 0 | | 100 | 0 | 2 | 200 | 3 |
| 4 | KAHRIMANOVIĆ, Aida Ipon, Sombor | 100 | 0 | 0 | | 0 | 1 | 100 | 3 |
| 5 | OSTOJIĆ, Sara TSK Temerin, Temerin | 100 | 10 | 10 | 100 | | 4 | 220 | 1 |

Bodovi: Ippon 100 / Wazaari 10 / Kazna 0.5

Redosled borbi: 1 - 2, 3 - 4 / 1 - 5, 2 - 3 / 4 - 5, 1 - 3 / 2 - 4, 3 - 5 / 1 - 4, 2 - 5

| BORBE | TAKMIČAR | BODOVA | BODOVA | TAKMIČAR | VREME |
|-------|--|------------|------------|--|-------|
| 1 - 2 | LUKIĆ, Sara Obrenovac, Obrenovac | 0 | 100 | STOJANOVSKI, Jelena Dinamo, Pančevo | 0:47 |
| 3 - 4 | MALINOSKA, Elena Bušido, Prilep | 100 | 0 | KAHRIMANOVIĆ, Aida Ipon, Sombor | 1:51 |
| 1 - 5 | LUKIĆ, Sara Obrenovac, Obrenovac | 0 | 100 | OSTOJIĆ, Sara TSK Temerin, Temerin | 0:02 |
| 2 - 3 | STOJANOVSKI, Jelena Dinamo, Pančevo | 100 | 0 | MALINOSKA, Elena Bušido, Prilep | 1:22 |
| 4 - 5 | KAHRIMANOVIĆ, Aida Ipon, Sombor | 0 | 100 | OSTOJIĆ, Sara TSK Temerin, Temerin | 0:43 |
| 1 - 3 | LUKIĆ, Sara Obrenovac, Obrenovac | 0 | 100 | MALINOSKA, Elena Bušido, Prilep | 0:01 |
| 2 - 4 | STOJANOVSKI, Jelena Dinamo, Pančevo | 100 | 0 | KAHRIMANOVIĆ, Aida Ipon, Sombor | 0:51 |
| 3 - 5 | MALINOSKA, Elena Bušido, Prilep | 0 | 10 | OSTOJIĆ, Sara TSK Temerin, Temerin | 2:59 |
| 1 - 4 | LUKIĆ, Sara Obrenovac, Obrenovac | 0 | 100 | KAHRIMANOVIĆ, Aida Ipon, Sombor | 0:02 |
| 2 - 5 | STOJANOVSKI, Jelena Dinamo, Pančevo | 0 | 10 | OSTOJIĆ, Sara TSK Temerin, Temerin | 2:59 |

REZULTAT

| | |
|------------------------|-----|
| 1. OSTOJIĆ, Sara | TSK |
| 2. STOJANOVSKI, Jelena | DIN |
| 3. MALINOSKA, Elena | BUS |
| 3. KAHRIMANOVIĆ, Aida | IPO |
| 5. LUKIĆ, Sara | OBR |

21. Međunarodni džudo turnir TURIJA 2019

Turija, 03.03.2019 - Starije pionirke



-44kg

5 takmičarki

| | TAKMIČAR | POBEDNIČKI BODOVI | | | | | POBEDA | BODOVA | MESTO |
|---|--|-------------------|-----|-----|-----|---|--------|--------|-------|
| | | 1 | 2 | 3 | 4 | 5 | | | |
| 1 | VELIČKOVIĆ, Staša Fajter, Obrenovac | | 10 | 100 | 100 | 0 | 3 | 210 | 2 |
| 2 | PEŠIĆ, Marta Jedinstvo, Kačarevo | 0 | | 100 | 100 | 0 | 2 | 200 | 3 |
| 3 | ILIESKA, Stefani Bušido, Prilep | 0 | 0 | | 0 | 0 | 0 | 0 | 5 |
| 4 | VIŠNIĆ, Nađa Sirig, Sirig | 0 | 0 | 100 | | 0 | 1 | 100 | 3 |
| 5 | VUKADINOVIĆ, Đurđa Ishi, Beograd | 100 | 100 | 100 | 10 | | 4 | 310 | 1 |

Bodovi: Ippon 100 / Wazaari 10 / Kazna 0.5

Redosled borbi: 1 - 2, 3 - 4 / 1 - 5, 2 - 3 / 4 - 5, 1 - 3 / 2 - 4, 3 - 5 / 1 - 4, 2 - 5

| BORBE | TAKMIČAR | BODOVA | BODOVA | TAKMIČAR | VREME |
|-------|--|------------|------------|-------------------------------------|-------|
| 1 - 2 | VELIČKOVIĆ, Staša Fajter, Obrenovac | 10 | 0 | PEŠIĆ, Marta Jedinstvo, Kačarevo | 2:59 |
| 3 - 4 | ILIESKA, Stefani Bušido, Prilep | 0 | 100 | VIŠNIĆ, Nađa Sirig, Sirig | 0:10 |
| 1 - 5 | VELIČKOVIĆ, Staša Fajter, Obrenovac | 0 | 100 | VUKADINOVIĆ, Đurđa Ishi, Beograd | 0:42 |
| 2 - 3 | PEŠIĆ, Marta Jedinstvo, Kačarevo | 100 | 0 | ILIESKA, Stefani Bušido, Prilep | 0:05 |
| 4 - 5 | VIŠNIĆ, Nađa Sirig, Sirig | 0 | 10 | VUKADINOVIĆ, Đurđa Ishi, Beograd | 2:59 |
| 1 - 3 | VELIČKOVIĆ, Staša Fajter, Obrenovac | 100 | 0 | ILIESKA, Stefani Bušido, Prilep | 0:21 |
| 2 - 4 | PEŠIĆ, Marta Jedinstvo, Kačarevo | 100 | 0 | VIŠNIĆ, Nađa Sirig, Sirig | 2:30 |
| 3 - 5 | ILIESKA, Stefani Bušido, Prilep | 0 | 100 | VUKADINOVIĆ, Đurđa Ishi, Beograd | 0:28 |
| 1 - 4 | VELIČKOVIĆ, Staša Fajter, Obrenovac | 100 | 0 | VIŠNIĆ, Nađa Sirig, Sirig | 1:18 |
| 2 - 5 | PEŠIĆ, Marta Jedinstvo, Kačarevo | 0 | 100 | VUKADINOVIĆ, Đurđa Ishi, Beograd | 0:59 |

REZULTAT

1. VUKADINOVIĆ, Đurđa ISH
2. VELIČKOVIĆ, Staša FAJ
3. PEŠIĆ, Marta JED
3. VIŠNIĆ, Nađa SIR
5. ILIESKA, Stefani BUS

21. Međunarodni džudo turnir TURIJIA 2019

Turija, 03.03.2019 - Starije pionirke



-48kg

10 takmičarki

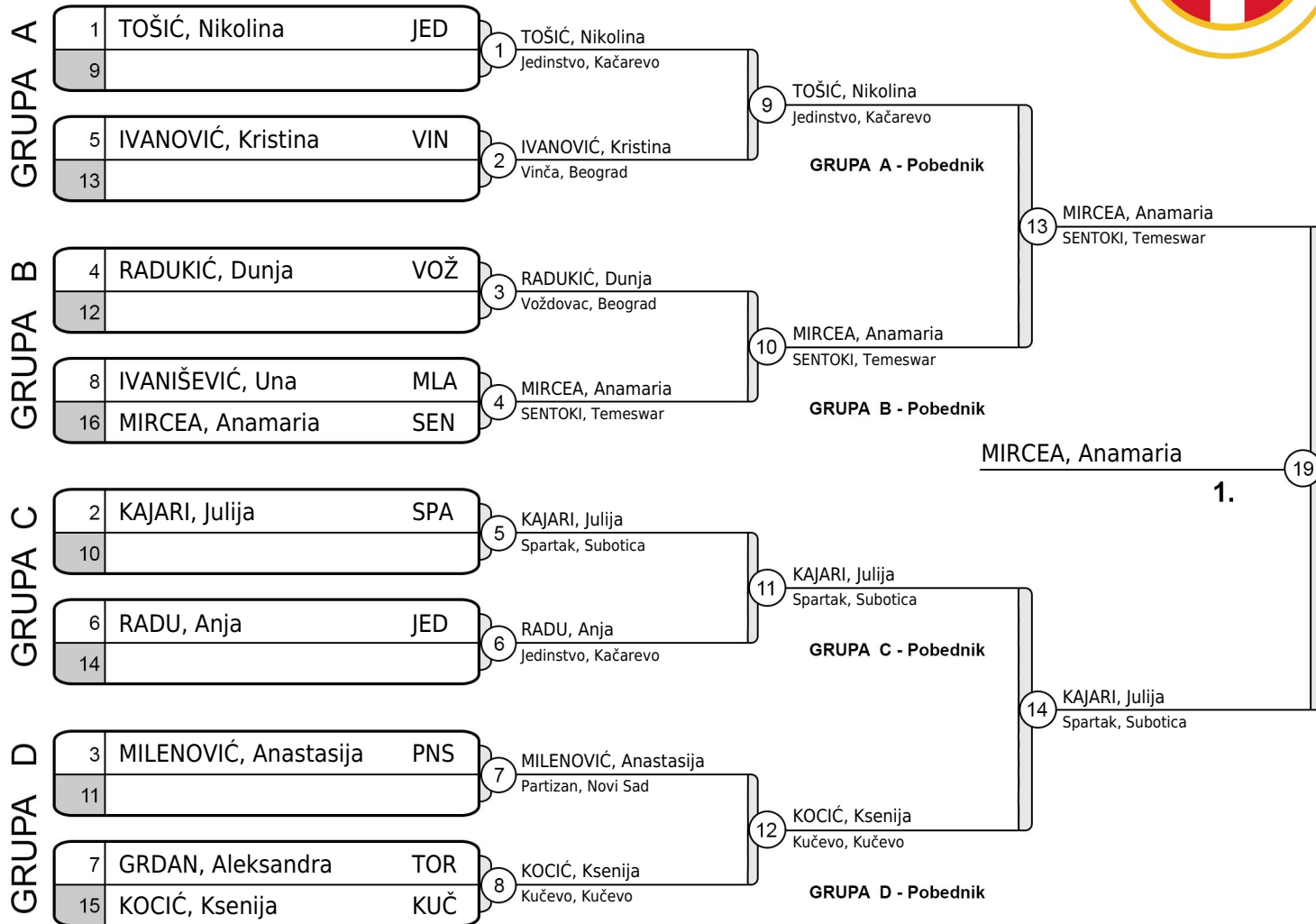

REZULTAT

- | | | |
|----|------------------|-----|
| 1. | MIRCEA, Anamaria | SEN |
| 2. | KAJARI, Julija | SPA |
| 3. | RADUKIĆ, Dunja | VOŽ |
| 3. | KOCIĆ, Ksenija | KUČ |
| 5. | TOŠIĆ, Nikolina | JED |
| 5. | RADU, Anja | JED |
| 7. | IVANIŠEVIĆ, Una | MLA |
| 7. | | |

REPASAŽ

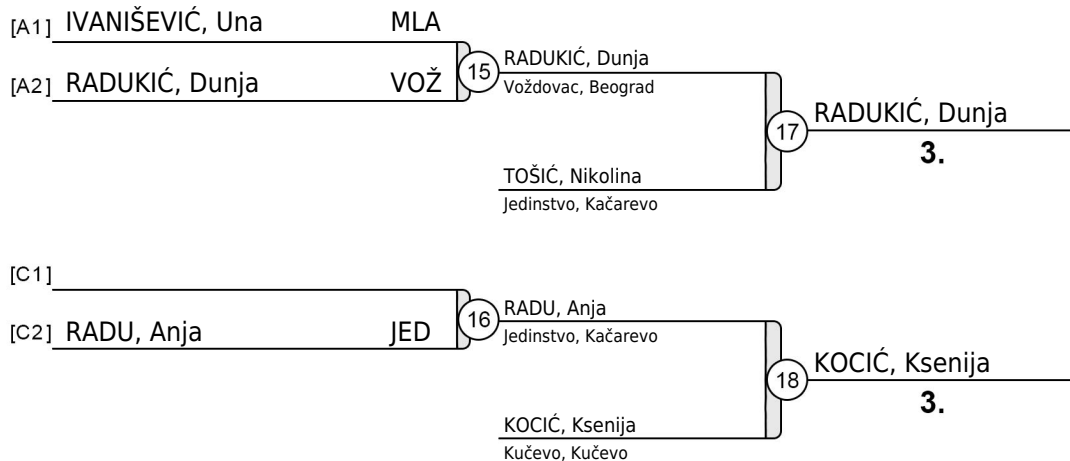

21. Međunarodni džudo turnir TURIJA 2019

Turija, 03.03.2019 - Starije pionirke



-52kg

6 takmičarki

| BORBE | TAKMIČAR | BODOVA | BODOVA | TAKMIČAR | VREME |
|-------|---|--------|--------|--|-------|
| 1 - 2 | KRŠIĆ, Marija Rakovica, Beograd | 100 | 0 | LOLIĆ, Anđela Crvena Zvezda, Beograd | 1:13 |
| 1 - 3 | KRŠIĆ, Marija Rakovica, Beograd | 100 | 0 | POPOVIĆ, Sandra Srpski Soko, Mali Zvornik | 1:40 |
| 2 - 3 | LOLIĆ, Anđela Crvena Zvezda, Beograd | 100 | 0 | POPOVIĆ, Sandra Srpski Soko, Mali Zvornik | 0:39 |

| | | | |
|----------------------|-----|---|---|
| [A1] KRŠIĆ, Marija | RAK | 7 | KRŠIĆ, Marija Rakovica, Beograd |
| [B2] OANA, Georgia | PHO | | |
| [B1] DOHORE, Jakline | MRD | 8 | DOHORE, Jakline MAKO RYU - DESANT, Bucharest |
| [A2] LOLIĆ, Anđela | CZB | | |
| | | 9 | KRŠIĆ, Marija Rakovica, Beograd |

| BORBE | TAKMIČAR | BODOVA | BODOVA | TAKMIČAR | VREME |
|-------|--|--------|--------|---|-------|
| 4 - 5 | OANA, Georgia Judo Phoenix, Timisoara | 100 | 0 | PRODANOV, Anđela Mladost, Bečej | 1:17 |
| 4 - 6 | OANA, Georgia Judo Phoenix, Timisoara | 0 | 100 | DOHORE, Jakline MAKO RYU - DESANT, Bucharest | 0:58 |
| 5 - 6 | PRODANOV, Anđela Mladost, Bečej | 0 | 100 | DOHORE, Jakline MAKO RYU - DESANT, Bucharest | 1:11 |

BODOVI: Ippon 100 / Wazaari 10 / Kazna 0.5

Redosled borbi: 1 - 2 / 4 - 5 / 1 - 3 / 4 - 6 / 2 - 3 / 5 - 6

REZULTAT

| | |
|---------------------|-----|
| 1. KRŠIĆ, Marija | RAK |
| 2. DOHORE, Jakline | MRD |
| 3. OANA, Georgia | PHO |
| 3. LOLIĆ, Anđela | CZB |
| 5. POPOVIĆ, Sandra | SRS |
| 5. PRODANOV, Anđela | MLA |

21. Međunarodni džudo turnir TURIJA 2019

Turija, 03.03.2019 - Starije pionirke



-57kg

15 takmičarki

GRUPA A

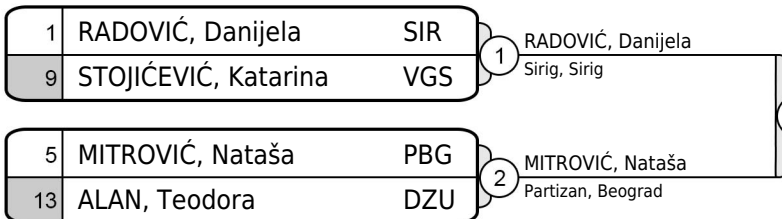

RADOVIĆ, Danijela

Sirig, Sirig

GRUPA A - Pobjednik

GRUPA B

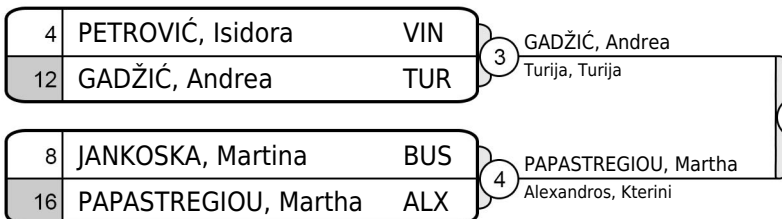

GADŽIĆ, Andrea

Turija, Turija

GRUPA B - Pobjednik

JOVANOVIĆ, Milica

1.

GRUPA C

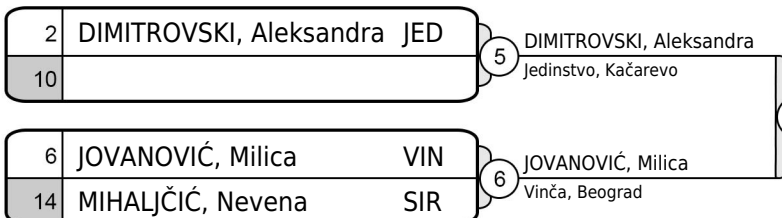

JOVANOVIĆ, Milica

Vinča, Beograd

GRUPA C - Pobjednik

JOVANOVIĆ, Milica

Vinča, Beograd

GRUPA D

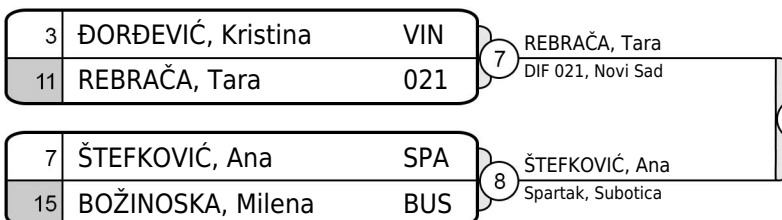

ŠTEFKOVIĆ, Ana

Spartak, Subotica

GRUPA D - Pobjednik

REZULTAT

- | | | |
|----|-------------------------|-----|
| 1. | JOVANOVIĆ, Milica | VIN |
| 2. | RADOVIĆ, Danijela | SIR |
| 3. | MITROVIĆ, Nataša | PBG |
| 4. | MIHALJČIĆ, Nevena | SIR |
| 5. | GADŽIĆ, Andrea | TUR |
| 6. | ŠTEFKOVIĆ, Ana | SPA |
| 7. | STOJIĆEVIĆ, Katarina | VGS |
| 8. | DIMITROVSKI, Aleksandra | JED |

REPASAŽ

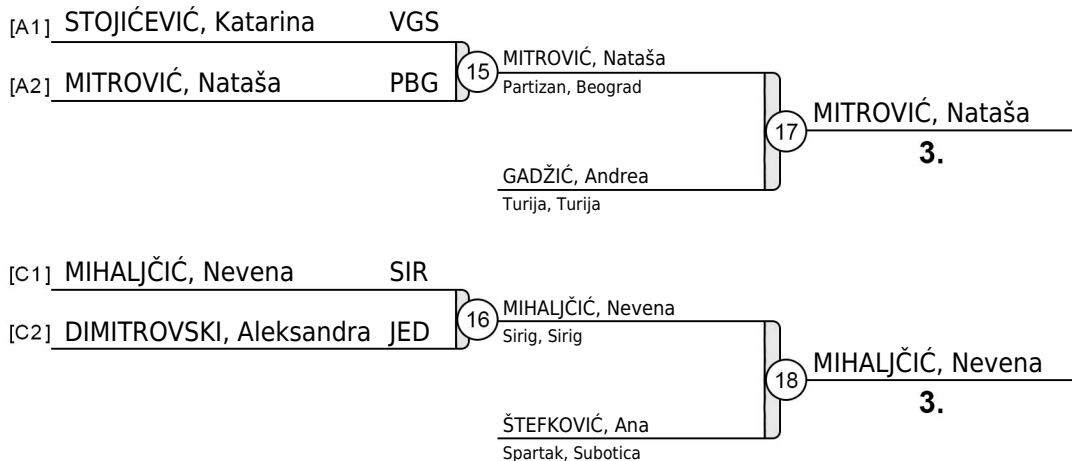

21. Međunarodni džudo turnir TURIJA 2019

Turija, 03.03.2019 - Starije pionirke



-63kg

5 takmičarki

| | TAKMIČAR | POBEDNIČKI BODOVI | | | | | POBEDA | BODOVA | MESTO |
|---|-------------------------------------|-------------------|-----|-----|-----|-----|--------|--------|-------|
| | | 1 | 2 | 3 | 4 | 5 | | | |
| 1 | ĐEKIĆ, Tara Lokomotiva, Vršac | | 100 | 100 | 100 | 10 | 4 | 310 | 1 |
| 2 | BELIĆ, Anastasija Turija, Turija | 0 | | 100 | 100 | 100 | 3 | 300 | 2 |
| 3 | ĆERAN, Lana Bačka, Sombor | 0 | 0 | | 100 | 100 | 2 | 200 | 3 |
| 4 | GORGIESKA, Teona Bušido, Prilep | 0 | 0 | 0 | | 100 | 1 | 100 | 3 |
| 5 | DIZDAR, Sara Vrbas, Vrbas | 0 | 0 | 0 | 0 | | 0 | 0 | 5 |

Bodovi: Ippon 100 / Wazaari 10 / Kazna 0.5

Redosled borbi: 1 - 2, 3 - 4 / 1 - 5, 2 - 3 / 4 - 5, 1 - 3 / 2 - 4, 3 - 5 / 1 - 4, 2 - 5

| BORBE | TAKMIČAR | BODOVA | BODOVA | TAKMIČAR | VREME |
|-------|-------------------------------------|------------|----------|-------------------------------------|-------|
| 1 - 2 | ĐEKIĆ, Tara Lokomotiva, Vršac | 100 | 0 | BELIĆ, Anastasija Turija, Turija | 1:03 |
| 3 - 4 | ĆERAN, Lana Bačka, Sombor | 100 | 0 | GORGIESKA, Teona Bušido, Prilep | 0:54 |
| 1 - 5 | ĐEKIĆ, Tara Lokomotiva, Vršac | 10 | 0 | DIZDAR, Sara Vrbas, Vrbas | 0:00 |
| 2 - 3 | BELIĆ, Anastasija Turija, Turija | 100 | 0 | ĆERAN, Lana Bačka, Sombor | 0:05 |
| 4 - 5 | GORGIESKA, Teona Bušido, Prilep | 100 | 0 | DIZDAR, Sara Vrbas, Vrbas | 0:00 |
| 1 - 3 | ĐEKIĆ, Tara Lokomotiva, Vršac | 100 | 0 | ĆERAN, Lana Bačka, Sombor | 0:56 |
| 2 - 4 | BELIĆ, Anastasija Turija, Turija | 100 | 0 | GORGIESKA, Teona Bušido, Prilep | 0:07 |
| 3 - 5 | ĆERAN, Lana Bačka, Sombor | 100 | 0 | DIZDAR, Sara Vrbas, Vrbas | 0:00 |
| 1 - 4 | ĐEKIĆ, Tara Lokomotiva, Vršac | 100 | 0 | GORGIESKA, Teona Bušido, Prilep | 0:14 |
| 2 - 5 | BELIĆ, Anastasija Turija, Turija | 100 | 0 | DIZDAR, Sara Vrbas, Vrbas | 0:00 |

REZULTAT

| | |
|----------------------|-----|
| 1. ĐEKIĆ, Tara | LOK |
| 2. BELIĆ, Anastasija | TUR |
| 3. ĆERAN, Lana | BAČ |
| 3. GORGIESKA, Teona | BUS |
| 5. DIZDAR, Sara | VRB |

21. Međunarodni džudo turnir TURIJA 2019

Turija, 03.03.2019 - Starije pionirke

+63kg

2 takmičarke



| BORBE | TAKMIČAR | BODOVA | BODOVA | TAKMIČAR | VREME |
|------------------|--|--------|--------|---|-------|
| 1 - 2 | TMUŠIĆ, Maša Partizan, Novi Sad | 100 | 0 | JANESKA, Sara Bušido, Prilep | 1:48 |
| 1 - 2 | TMUŠIĆ, Maša Partizan, Novi Sad | 100 | 0 | JANESKA, Sara Bušido, Prilep | 0:25 |
| 1 - 2 | TMUŠIĆ, Maša Partizan, Novi Sad | | | JANESKA, Sara Bušido, Prilep | |

Bodovi: Ippon 100 / Wazaari 10 / Kazna 0.5

Kriterijum za određivanje pobednika: Dve pobeđe

REZULTAT

1. TMUŠIĆ, Maša PNS
2. JANESKA, Sara BUS