



REGIONALNO CS KADETI

Niš, 13.02.2021.

KADETI
-50KG
6 takmičara

	TAKMIČAR I KLUB	POBEDA	BODOVA
1	RADOJKOVIĆ, Đorđe Niš, Niš	2	20
2	SAVOVIĆ, Dušan Župa Aleksandrovac, Aleksandrovac	0	0
3	LOŽAJIĆ, Ilija Vuk, Niš	1	10

GRUPA A	TAKMIČAR I KLUB	POBEDA	BODOVA
GRUPA A	RADOJKOVIĆ, Đorđe NIŠ	1	RADOJKOVIĆ, Đorđe Niš, Niš
	SAVOVIĆ, Dušan ŽAL		
	RADOJKOVIĆ, Đorđe NIŠ	2	RADOJKOVIĆ, Đorđe Niš, Niš
	LOŽAJIĆ, Ilija VUK		
	SAVOVIĆ, Dušan ŽAL	3	LOŽAJIĆ, Ilija Vuk, Niš
	LOŽAJIĆ, Ilija VUK		

	TAKMIČAR I KLUB	POBEDA	BODOVA
4	VARINAC, Filip Župa Aleksandrovac, Aleksandrovac	1	10
5	SIMIĆ, Ognjen UDŽK Kinezis, Niš	2	20
6	ZDRAVKOVIĆ, Petar Šogun, Niš	0	0

GRUPA B	TAKMIČAR I KLUB	POBEDA	BODOVA
GRUPA B	VARINAC, Filip ŽAL	4	SIMIĆ, Ognjen UDŽK Kinezis, Niš
	SIMIĆ, Ognjen KIN		
	VARINAC, Filip ŽAL	5	VARINAC, Filip Župa Aleksandrovac, Aleksandrovac
	ZDRAVKOVIĆ, Petar ŠOG		
	SIMIĆ, Ognjen KIN	6	SIMIĆ, Ognjen UDŽK Kinezis, Niš
	ZDRAVKOVIĆ, Petar ŠOG		

FINALE	TAKMIČAR I KLUB	POBEDA	BODOVA
FINALE	RADOJKOVIĆ, Đorđe NIŠ	7	RADOJKOVIĆ, Đorđe Niš, Niš
	VARINAC, Filip ŽAL		
	SIMIĆ, Ognjen KIN	8	LOŽAJIĆ, Ilija Vuk, Niš
	LOŽAJIĆ, Ilija VUK		
		9	RADOJKOVIĆ, Đorđe Niš, Niš

Rezultati

1. RADOJKOVIĆ, Đorđe NIŠ
2. LOŽAJIĆ, Ilija VUK
3. VARINAC, Filip ŽAL
3. SIMIĆ, Ognjen KIN
5. SAVOVIĆ, Dušan ŽAL
5. ZDRAVKOVIĆ, Petar ŠOG



REGIONALNO CS KADETI

Niš, 13.02.2021.

KADETI
-55KG
6 takmičara

	TAKMIČAR I KLUB	POBEDA	BODOVA
1	HOT, Said Mladost, Tutin	2	20
2	POPOVIĆ, Nemanja Bor, Bor	0	0
3	DEDEIĆ, Adnan Tutin, Tutin	1	10

GRUPA A	HOT, Said MTU		1	HOT, Said	
	POPOVIĆ, Nemanja BOR			Mladost, Tutin	
	HOT, Said MTU		2	HOT, Said	
	DEDEIĆ, Adnan TUT			Mladost, Tutin	
	POPOVIĆ, Nemanja BOR		3	DEDEIĆ, Adnan	
	DEDEIĆ, Adnan TUT			Tutin, Tutin	

	TAKMIČAR I KLUB	POBEDA	BODOVA
4	SIMIĆ, Veljko UDŽK Kinezis, Niš	1	10
5	NIKOLIĆ, Aleksa Niš, Niš	2	20
6	POPOVIĆ, Lazar Šogun, Niš	0	0

GRUPA B	SIMIĆ, Veljko KIN		4	NIKOLIĆ, Aleksa	
	NIKOLIĆ, Aleksa NIŠ			Niš, Niš	
	SIMIĆ, Veljko KIN		5	SIMIĆ, Veljko	
	POPOVIĆ, Lazar ŠOG			UDŽK Kinezis, Niš	
	NIKOLIĆ, Aleksa NIŠ		6	NIKOLIĆ, Aleksa	
	POPOVIĆ, Lazar ŠOG			Niš, Niš	

FINALE	HOT, Said MTU		7	SIMIĆ, Veljko	
	SIMIĆ, Veljko KIN			UDŽK Kinezis, Niš	
	NIKOLIĆ, Aleksa NIŠ		8	NIKOLIĆ, Aleksa	
	DEDEIĆ, Adnan TUT			Niš, Niš	
			9	NIKOLIĆ, Aleksa	
				Niš, Niš	

Rezultati

- NIKOLIĆ, Aleksa NIŠ
- SIMIĆ, Veljko KIN
- HOT, Said MTU
- DEDEIĆ, Adnan TUT
- POPOVIĆ, Nemanja BOR
- POPOVIĆ, Lazar ŠOG



REGIONALNO CS KADETI

Niš, 13.02.2021.

KADETI
-60KG
8 takmičara

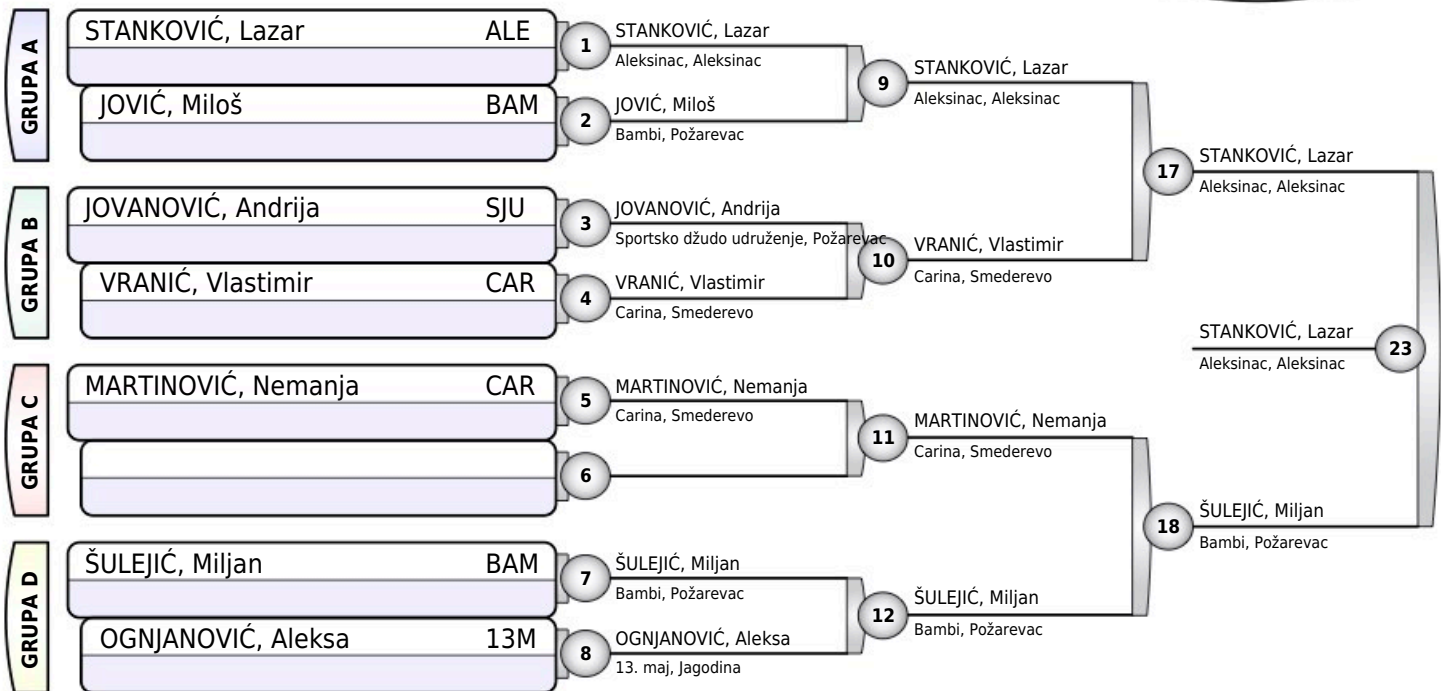

Rezultati

1. STANKOVIĆ, Lazar ALE
2. ŠULEJIĆ, Miljan BAM
3. JOVANOVIĆ, Andrija SJU
3. VRANIĆ, Vlastimir CAR
5. MARTINOVIĆ, Nemanja CAR
5. OGNJANOVIĆ, Aleksa 13M
7. JOVIĆ, Miloš BAM
- 7.

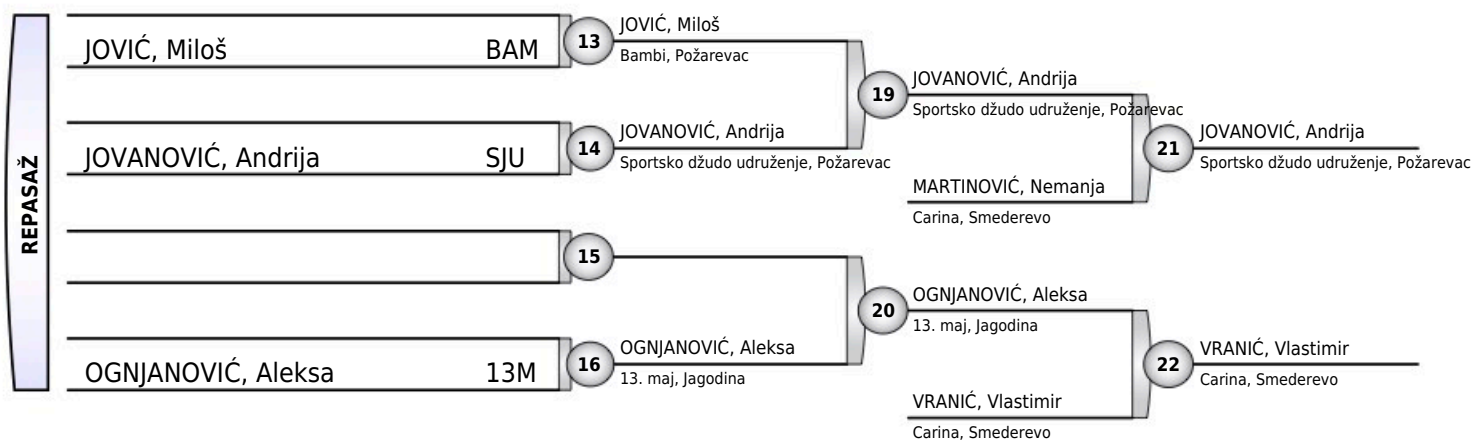



REGIONALNO CS KADETI

Niš, 13.02.2021.

KADETI
-66KG
11 takmičara

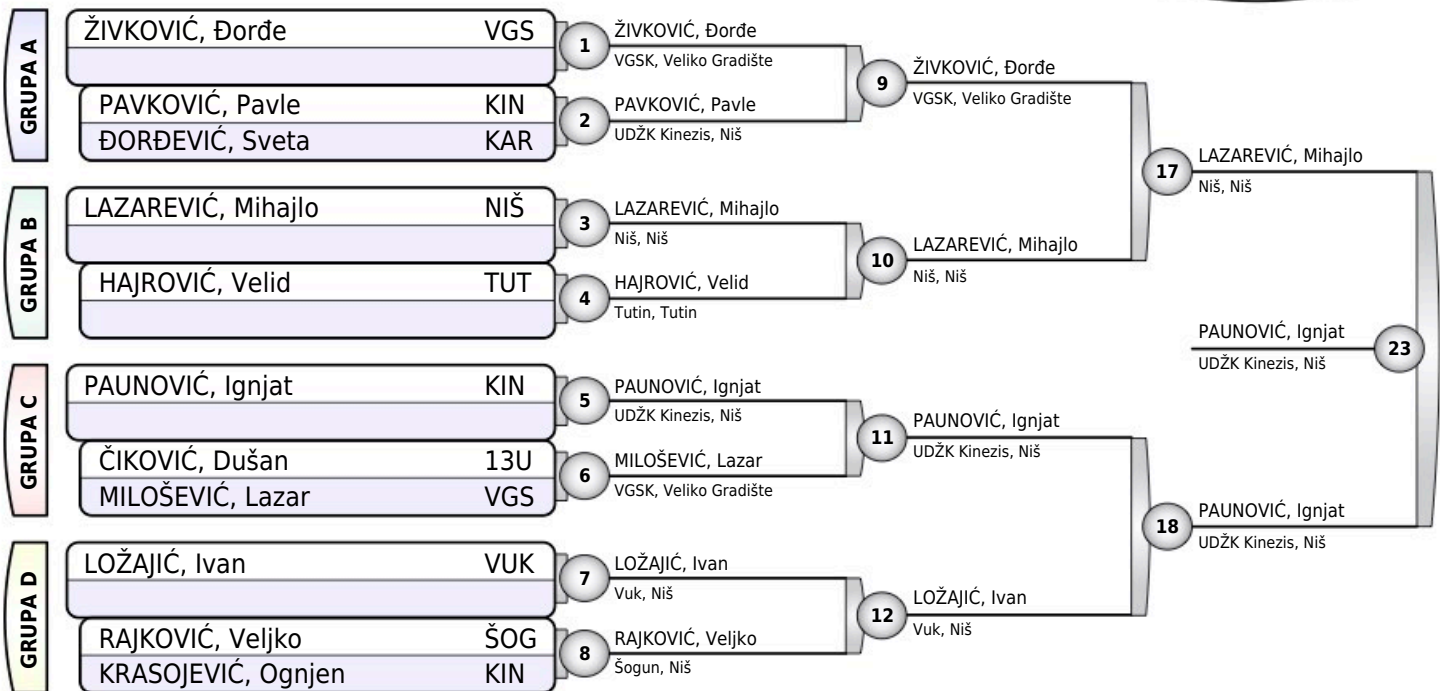

Rezultati

- | | | |
|----|--------------------|-----|
| 1. | PAUNOVIĆ, Ignjat | KIN |
| 2. | LAZAREVIĆ, Mihajlo | NIŠ |
| 3. | LOŽAJIĆ, Ivan | VUK |
| 3. | ŽIVKOVIĆ, Đorđe | VGS |
| 5. | HAJROVIĆ, Velid | TUT |
| 5. | MILOŠEVIĆ, Lazar | VGS |
| 7. | PAVKOVIĆ, Pavle | KIN |
| 7. | RAJKOVIĆ, Veljko | ŠOG |

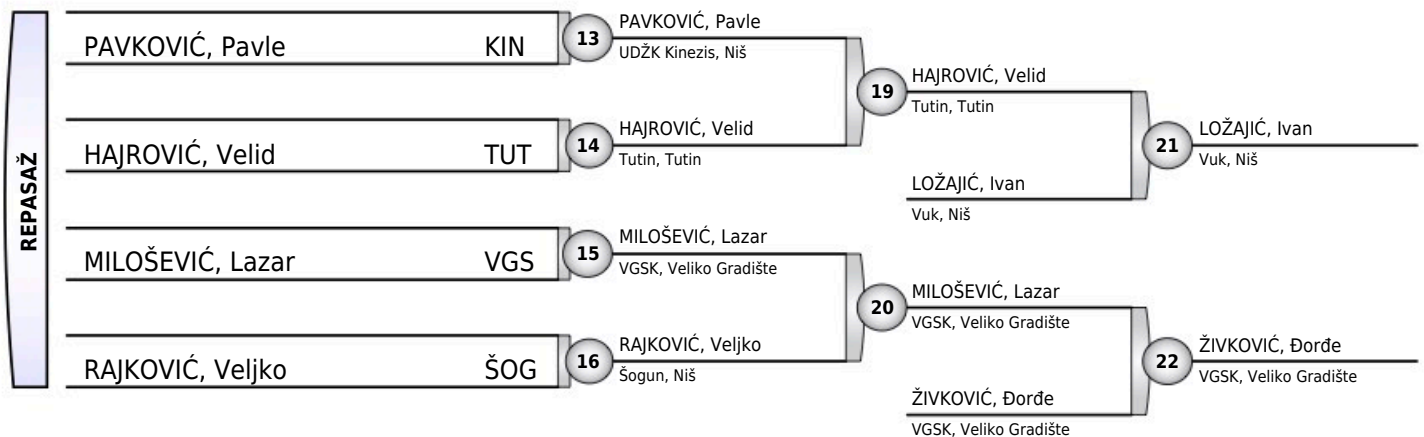



REGIONALNO CS KADETI

Niš, 13.02.2021.

KADETI
-73KG
8 takmičara

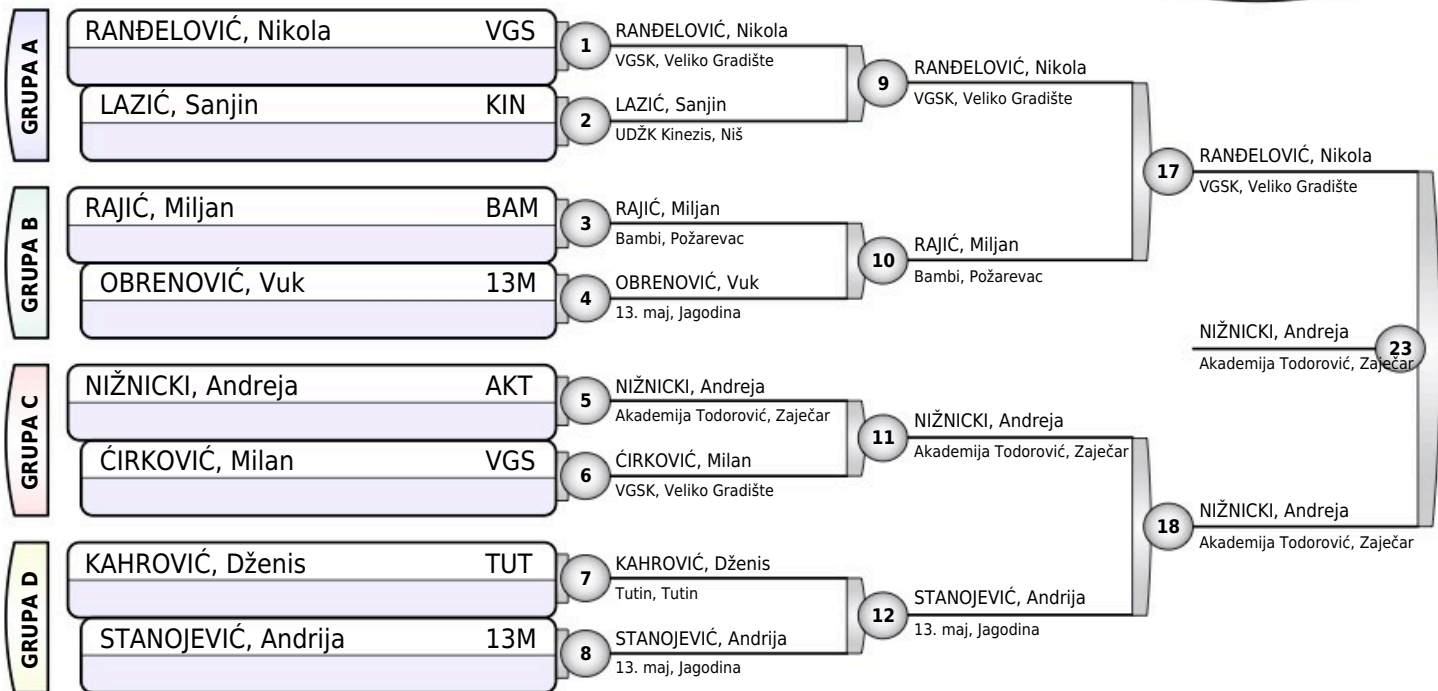

Rezultati

1. NIŽNICKI, Andreja (AKT)
2. RANĐELOVIĆ, Nikola (VGS)
3. OBRENOVIĆ, Vuk (13M)
3. ĆIRKOVIĆ, Milan (VGS)
5. STANOJEVIĆ, Andrija (13M)
5. RAJIĆ, Miljan (BAM)
7. LAZIĆ, Sanjin (KIN)
7. KAHROVIĆ, Dženis (TUT)

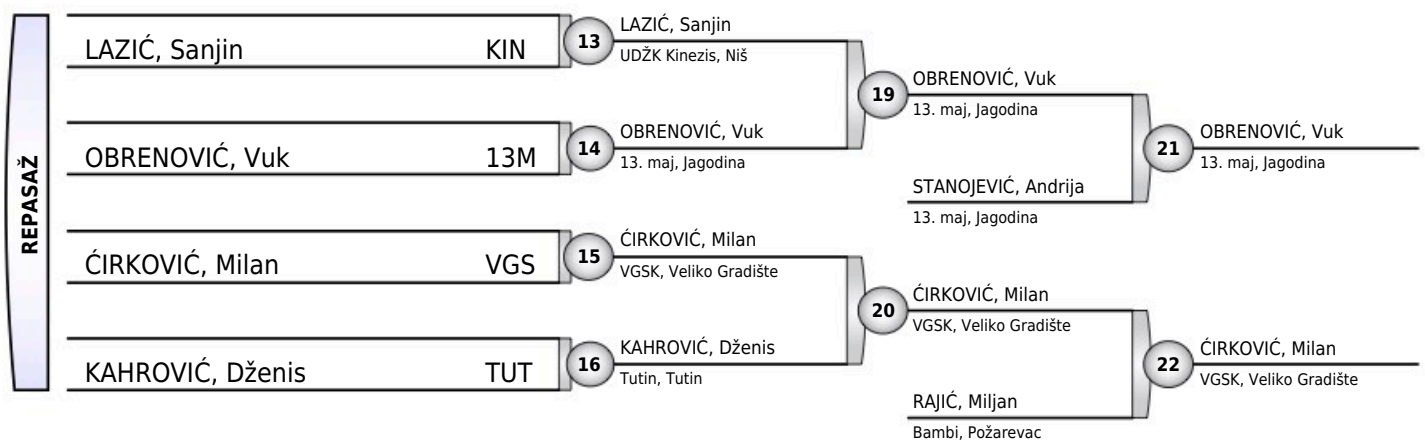



REGIONALNO CS KADETI

Niš, 13.02.2021.

KADETI
-81KG
5 takmičara

TAKMIČAR I KLUB	1	2	3	4	5	POBEDA	BODOVA	MESTO
1 PETROVIĆ, Ognjen UDŽK Kinezis, Niš		0	10	10	10	3	30	2
2 MISIĆ, Milan Leskovac, Leskovac	10		10	10	10	4	40	1
3 IVANOVIĆ, David Šogun, Niš	0	0		1	0	1	1	3
4 MILOJKOVIĆ, Mihajlo Aleksinac, Aleksinac	0	0	0		0	0	0	5
5 MILOŠEVIĆ, Matija VGSK, Veliko Gradište	0	0	10	10		2	20	3

PETROVIĆ, Ognjen	KIN	1	MISIĆ, Milan
MISIĆ, Milan	LES		Leskovac, Leskovac
IVANOVIĆ, David	ŠOG	2	IVANOVIĆ, David
MILOJKOVIĆ, Mihajlo	ALE		Šogun, Niš
PETROVIĆ, Ognjen	KIN	3	PETROVIĆ, Ognjen
MILOŠEVIĆ, Matija	VGS		UDŽK Kinezis, Niš
MISIĆ, Milan	LES	4	MISIĆ, Milan
IVANOVIĆ, David	ŠOG		Leskovac, Leskovac
MILOJKOVIĆ, Mihajlo	ALE	5	MILOŠEVIĆ, Matija
MILOŠEVIĆ, Matija	VGS		VGSK, Veliko Gradište
PETROVIĆ, Ognjen	KIN	6	PETROVIĆ, Ognjen
IVANOVIĆ, David	ŠOG		UDŽK Kinezis, Niš
MISIĆ, Milan	LES	7	MISIĆ, Milan
MILOJKOVIĆ, Mihajlo	ALE		Leskovac, Leskovac
IVANOVIĆ, David	ŠOG	8	MILOŠEVIĆ, Matija
MILOŠEVIĆ, Matija	VGS		VGSK, Veliko Gradište
PETROVIĆ, Ognjen	KIN	9	PETROVIĆ, Ognjen
MILOJKOVIĆ, Mihajlo	ALE		UDŽK Kinezis, Niš
MISIĆ, Milan	LES	10	MISIĆ, Milan
MILOŠEVIĆ, Matija	VGS		Leskovac, Leskovac

Rezultati

1. MISIĆ, Milan LES
2. PETROVIĆ, Ognjen KIN
3. MILOŠEVIĆ, Matija VGS
3. IVANOVIĆ, David ŠOG
5. MILOJKOVIĆ, Mihajlo ALE



REGIONALNO CS KADETI

Niš, 13.02.2021.

KADETI
-90KG
8 takmičara

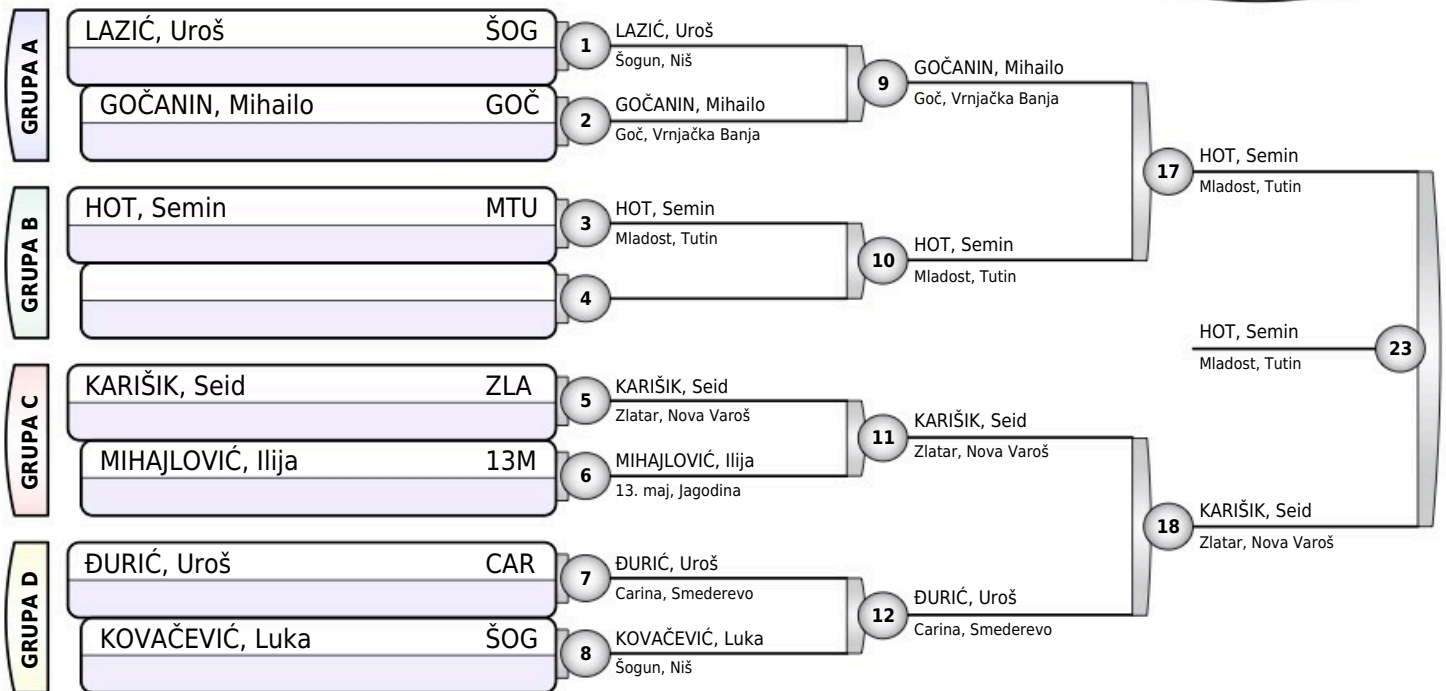

Rezultati

- | | |
|----------------------|-----|
| 1. HOT, Semin | MTU |
| 2. KARIŠIK, Seid | ZLA |
| 3. ĐURIĆ, Uroš | CAR |
| 3. MIHAJLOVIĆ, Ilija | 13M |
| 5. LAZIĆ, Uroš | ŠOG |
| 5. GOČANIN, Mihailo | GOČ |
| 7. KOVAČEVIĆ, Luka | ŠOG |
| 7. | |

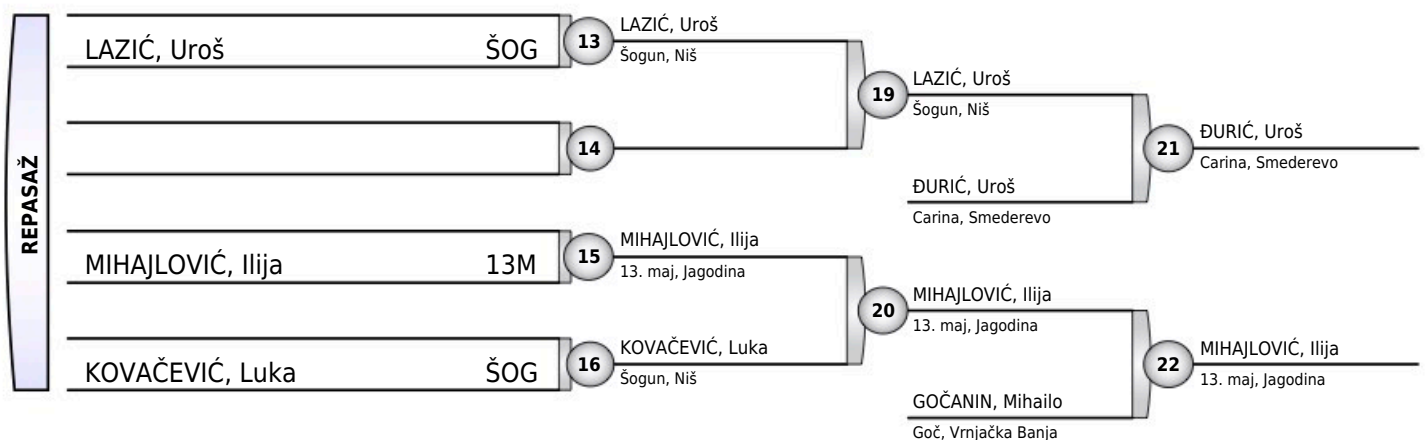



REGIONALNO CS KADETI

Niš, 13.02.2021.

KADETI
+90KG
3 takmičara

TAKMIČAR I KLUB	1	2	3	POBEDA	BODOVA	MESTO
1 GLIGORIJEVIĆ, Jovan Džudo udruženje Karađorđević, Sokobanja		10	0	1	10	2
2 ĐORĐEVIĆ, Sreten Džudo udruženje Karađorđević, Sokobanja	0		0	0	0	3
3 ČAUŠEVIĆ, Rijad Tutin, Tutin	10	10		2	20	1

GLIGORIJEVIĆ, Jovan	KAR	1	GLIGORIJEVIĆ, Jovan
ĐORĐEVIĆ, Sreten	KAR		Džudo udruženje Karađorđević, Sokobanja
GLIGORIJEVIĆ, Jovan	KAR	2	ČAUŠEVIĆ, Rijad
ČAUŠEVIĆ, Rijad	TUT		Tutin, Tutin
ĐORĐEVIĆ, Sreten	KAR	3	ČAUŠEVIĆ, Rijad
ČAUŠEVIĆ, Rijad	TUT		Tutin, Tutin

Rezultati

- | | |
|------------------------|-----|
| 1. ČAUŠEVIĆ, Rijad | TUT |
| 2. GLIGORIJEVIĆ, Jovan | KAR |
| 3. ĐORĐEVIĆ, Sreten | KAR |



REGIONALNO CS KADETI

Niš, 13.02.2021.

KADETKINJE

-44KG

1 takmičarka

ARITONVIĆ, Nikolina

OBO

1

ARITONVIĆ, Nikolina

OJK Bor, Bor

Rezultati

1. ARITONVIĆ, Nikolina

OBO



REGIONALNO CS KADETI

Niš, 13.02.2021.

KADETKINJE

-48KG

4 takmičarki

TAKMIČAR I KLUB	1	2	3	4	POBEDA	BODOVA	MESTO
1 KOS, Ines Akademija Todorović, Zaječar		0	10	10	2	20	2
2 MILOVANOVIĆ, Jastra Niš, Niš	10		10	10	3	30	1
3 JAGODIĆ, Anastasija 13. maj, Ub	0	0		10	1	10	3
4 STANIMIROVIĆ, Nikolina Carina, Smederevo	0	0	0		0	0	3

KOS, Ines	AKT	1	MILOVANOVIĆ, Jastra
MILOVANOVIĆ, Jastra	NIŠ		Niš, Niš
JAGODIĆ, Anastasija	13U	2	JAGODIĆ, Anastasija
STANIMIROVIĆ, Nikolina	CAR		13. maj, Ub
KOS, Ines	AKT	3	KOS, Ines
JAGODIĆ, Anastasija	13U		Akademija Todorović, Zaječar
MILOVANOVIĆ, Jastra	NIŠ	4	MILOVANOVIĆ, Jastra
STANIMIROVIĆ, Nikolina	CAR		Niš, Niš
KOS, Ines	AKT	5	KOS, Ines
STANIMIROVIĆ, Nikolina	CAR		Akademija Todorović, Zaječar
MILOVANOVIĆ, Jastra	NIŠ	6	MILOVANOVIĆ, Jastra
JAGODIĆ, Anastasija	13U		Niš, Niš

Rezultati

1. MILOVANOVIĆ, Jastra NIŠ
2. KOS, Ines AKT
3. JAGODIĆ, Anastasija 13U
3. STANIMIROVIĆ, Nikolina CAR



REGIONALNO CS KADETI

Niš, 13.02.2021.

KADETKINJE

-52KG

5 takmičarki

TAKMIČAR I KLUB	1	2	3	4	5	POBEDA	BODOVA	MESTO
1 KOCIĆ, Ksenija Kučevo, Kučevo		10	10	10	10	4	40	1
2 LAZIĆ, Natalija Brus, Brus	0		10	10	0	2	20	3
3 IVKOVIĆ, Milica Župa Aleksandrovac, Aleksandrovac	0	0		10	10	2	20	2
4 ARSIĆ, Tijana Župa Aleksandrovac, Aleksandrovac	0	0	0		0	0	0	5
5 VASILJEVIĆ, Anđela Bambi, Požarevac	0	10	0	10		2	20	3

KOCIĆ, Ksenija	KUČ	1	KOCIĆ, Ksenija
LAZIĆ, Natalija	BRU		Kučevo, Kučevo
IVKOVIĆ, Milica	ŽAL	2	IVKOVIĆ, Milica
ARSIĆ, Tijana	ŽAL		Župa Aleksandrovac, Aleksandrovac
KOCIĆ, Ksenija	KUČ	3	KOCIĆ, Ksenija
VASILJEVIĆ, Anđela	BAM		Kučevo, Kučevo
LAZIĆ, Natalija	BRU	4	LAZIĆ, Natalija
IVKOVIĆ, Milica	ŽAL		Brus, Brus
ARSIĆ, Tijana	ŽAL	5	VASILJEVIĆ, Anđela
VASILJEVIĆ, Anđela	BAM		Bambi, Požarevac
KOCIĆ, Ksenija	KUČ	6	KOCIĆ, Ksenija
IVKOVIĆ, Milica	ŽAL		Kučevo, Kučevo
LAZIĆ, Natalija	BRU	7	LAZIĆ, Natalija
ARSIĆ, Tijana	ŽAL		Brus, Brus
IVKOVIĆ, Milica	ŽAL	8	IVKOVIĆ, Milica
VASILJEVIĆ, Anđela	BAM		Župa Aleksandrovac, Aleksandrovac
KOCIĆ, Ksenija	KUČ	9	KOCIĆ, Ksenija
ARSIĆ, Tijana	ŽAL		Kučevo, Kučevo
LAZIĆ, Natalija	BRU	10	VASILJEVIĆ, Anđela
VASILJEVIĆ, Anđela	BAM		Bambi, Požarevac

Rezultati

- | | |
|-----------------------|-----|
| 1. KOCIĆ, Ksenija | KUČ |
| 2. IVKOVIĆ, Milica | ŽAL |
| 3. VASILJEVIĆ, Anđela | BAM |
| 3. LAZIĆ, Natalija | BRU |
| 5. ARSIĆ, Tijana | ŽAL |



REGIONALNO CS KADETI

Niš, 13.02.2021.

KADETKINJE
-57KG
4 takmičarki

TAKMIČAR I KLUB	1	2	3	4	POBEDA	BODOVA	MESTO
1 STOJIČIĆ, Kristina Vuk, Niš		10	0	0	1	10	3
2 RAJIĆ, Tamara Sportsko džudo udruženje, Požarevac	0		10	0	1	10	2
3 ĐORĐEVIĆ, Tamara 13. maj, Ub	10	0		0	1	10	3
4 IVANOVIĆ, Anđela Šogun, Niš	10	10	10		3	30	1

STOJIČIĆ, Kristina	VUK	1	STOJIČIĆ, Kristina
RAJIĆ, Tamara	SJU		Vuk, Niš
ĐORĐEVIĆ, Tamara	13U	2	IVANOVIĆ, Anđela
IVANOVIĆ, Anđela	ŠOG		Šogun, Niš
STOJIČIĆ, Kristina	VUK	3	ĐORĐEVIĆ, Tamara
ĐORĐEVIĆ, Tamara	13U		13. maj, Ub
RAJIĆ, Tamara	SJU	4	IVANOVIĆ, Anđela
IVANOVIĆ, Anđela	ŠOG		Šogun, Niš
STOJIČIĆ, Kristina	VUK	5	IVANOVIĆ, Anđela
IVANOVIĆ, Anđela	ŠOG		Šogun, Niš
RAJIĆ, Tamara	SJU	6	RAJIĆ, Tamara
ĐORĐEVIĆ, Tamara	13U		Sportsko džudo udruženje, Požarevac

Rezultati

1. IVANOVIĆ, Anđela ŠOG
2. RAJIĆ, Tamara SJU
3. STOJIČIĆ, Kristina VUK
3. ĐORĐEVIĆ, Tamara 13U



REGIONALNO CS KADETI

Niš, 13.02.2021.

KADETKINJE

-63KG

4 takmičarki

TAKMIČAR I KLUB	1	2	3	4	POBEDA	BODOVA	MESTO
1 JOVIĆ, Milica Bambi, Požarevac		0	10	10	2	20	2
2 MARKOVIĆ, Kristina Mladost Carina, Smederevo	1		10	10	3	21	1
3 JOVANOVIĆ, Milica Bor, Bor	0	0		1	1	1	3
4 MILOVANOVIĆ, Anđela UDŽK Kinezis, Niš	0	0	0		0	0	3

JOVIĆ, Milica	BAM	1	MARKOVIĆ, Kristina
MARKOVIĆ, Kristina	MLC		Mladost Carina, Smederevo
JOVANOVIĆ, Milica	BOR	2	JOVANOVIĆ, Milica
MILOVANOVIĆ, Anđela	KIN		Bor, Bor
JOVIĆ, Milica	BAM	3	JOVIĆ, Milica
JOVANOVIĆ, Milica	BOR		Bambi, Požarevac
MARKOVIĆ, Kristina	MLC	4	MARKOVIĆ, Kristina
MILOVANOVIĆ, Anđela	KIN		Mladost Carina, Smederevo
JOVIĆ, Milica	BAM	5	JOVIĆ, Milica
MILOVANOVIĆ, Anđela	KIN		Bambi, Požarevac
MARKOVIĆ, Kristina	MLC	6	MARKOVIĆ, Kristina
JOVANOVIĆ, Milica	BOR		Mladost Carina, Smederevo

Rezultati

1. MARKOVIĆ, Kristina MLC
2. JOVIĆ, Milica BAM
3. JOVANOVIĆ, Milica BOR
3. MILOVANOVIĆ, Anđela KIN



REGIONALNO CS KADETI

Niš, 13.02.2021.

KADETKINJE

-70KG

2 takmičarke

CVETKOVIĆ, Ana	ŠOG	1	ŽIVKOVIĆ, Sofija 13. maj, Jagodina
ŽIVKOVIĆ, Sofija	13M		
CVETKOVIĆ, Ana	ŠOG	2	ŽIVKOVIĆ, Sofija 13. maj, Jagodina
ŽIVKOVIĆ, Sofija	13M		
		3	

Rezultati

- | | |
|---------------------|-----|
| 1. ŽIVKOVIĆ, Sofija | 13M |
| 2. CVETKOVIĆ, Ana | ŠOG |



REGIONALNO CS KADETI

Niš, 13.02.2021.

KADETKINJE

+70KG

3 takmičarke

TAKMIČAR I KLUB	1	2	3	POBEDA	BODOVA	MESTO
1 BENDIĆ, Vanja Carina, Smederevo		10	0	1	10	2
2 PAVLOVIĆ, Emilija Leskovac, Leskovac	0		0	0	0	3
3 MLADENOVIĆ, Staša Bor, Bor	10	10		2	20	1

BENDIĆ, Vanja	CAR	1	BENDIĆ, Vanja
PAVLOVIĆ, Emilija	LES		Carina, Smederevo
BENDIĆ, Vanja	CAR	2	MLADENOVIĆ, Staša
MLADENOVIĆ, Staša	BOR		Bor, Bor
PAVLOVIĆ, Emilija	LES	3	MLADENOVIĆ, Staša
MLADENOVIĆ, Staša	BOR		Bor, Bor

Rezultati

1. MLADENOVIĆ, Staša BOR
2. BENDIĆ, Vanja CAR
3. PAVLOVIĆ, Emilija LES